

SA's Leading Past Year

Exam Paper Portal

S T U D Y

You have Downloaded, yet Another Great Resource to assist you with your Studies 😊

Thank You for Supporting SA Exam Papers

Your Leading Past Year Exam Paper Resource Portal

Visit us @ www.saexampapers.co.za



**SA EXAM
PAPERS**

Via Afrika Life Sciences

Grade 12 Study Guide

C.E. Whitlock, M.Bowie, J.J.J. de Beer, E.J.P. Pretorius,
M.A. Khan, F. Naude, S.M. Wiese



Our Teachers. Our Future.



Study Guide

Life Sciences

Grade 12



Our Teachers. Our Future.

ISBN: 978-1-41546-329-1

Contents

General Introduction	1
Overview of the National Examination for Life Sciences Grade 12	1
Strand 1 Life at the molecular, cellular and tissue level.....	3
Overview	3
Topic 1 DNA: The code of life.....	4
Topic 2 Meiosis.....	18
Strand 2 Life processes in plants and animals.....	31
Overview	31
Topic 3 Reproduction in vertebrates.....	32
Strands 1 and 4 Life at the molecular, cellular and tissue level; diversity, change and continuity	49
Overview	49
Topic 4 Genetics and inheritance.....	50
Strand 2 Life processes in plants and animals.....	64
Overview	64
Topic 5 Responding to the environment.....	65
Strand 4 Diversity, change and continuity.....	97
Overview	97
Topic 6 Evolution by natural selection	98
Topic 7 Human evolution	117
Strand 3 Environmental studies.....	132
Overview	132
Topic 8 Human impact on the environment: Revision	132
Example examination papers.....	155
Answers to examination papers.....	186

General Introduction

This study guide helps you to prepare for the end-of-year Life Sciences Grade 12 exam. It does NOT cover the entire curriculum, but it does focus on the areas of regularly examined content in each strand and topic.

You need to use this study guide to identify your areas of weakness, improve your understanding, and assist your memory retention.

To ensure the highest level of performance, you should also cover the remaining sections of the curriculum using your textbook, class notes, revision questions and examination papers.

Overview of the National Examination for Life Sciences

Grade 12

The following topics make up each of the TWO Life Sciences exam papers that you write at the end of the year:

Table 1 Content and approximate mark breakdown for Paper 1 and 2			
Paper 1		Paper 2	
<ul style="list-style-type: none"> • Meiosis • Reproduction in vertebrates • Human reproduction 	11 marks 6 marks 31 marks	<ul style="list-style-type: none"> • DNA: Code of life • Meiosis 	27 marks 12 marks
<ul style="list-style-type: none"> • Responding to the environment (humans) 	40 marks	<ul style="list-style-type: none"> • Genetics and inheritance 	45 marks
<ul style="list-style-type: none"> • Human endocrine system • Homeostasis in humans • Responding to the environment (plants) 	15 marks 11 marks 11 marks	<ul style="list-style-type: none"> • Evolution through natural selection 	23 marks
<ul style="list-style-type: none"> • Human impact on the environment (Grade 11) 	25 marks	<ul style="list-style-type: none"> • Human evolution 	43 marks
Total	150 marks	Total	150 marks

Both Paper 1 and Paper 2 will include the following types of questions:

Table 2 Layout of Paper 1 and 2		
Section	Type of question	Marks
A	Short answer, objective questions such as multiple-choice questions, terminology, columns/statement and items.	50
B	A variety of longer questions based on graphs, diagrams or text. There will be two questions of 30 marks each. Both of these questions will be divided into three to four subsections.	2 × 30
C	Consists of two parts: <ul style="list-style-type: none"> • Data response questions. • A mini-essay (this may address one or more learning outcome). 	20 20

Overview

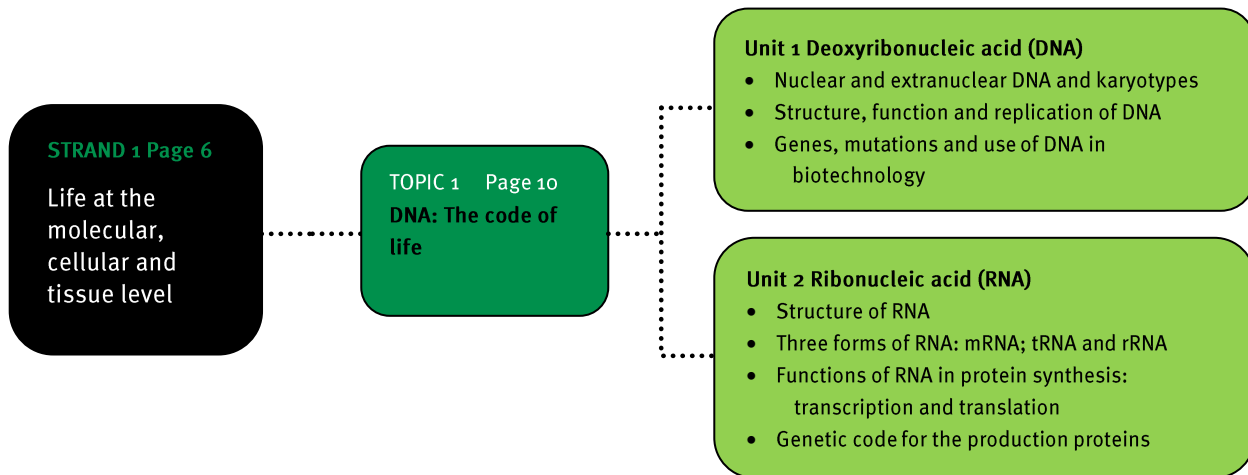

Units 1 and 2

Nucleic acids are large molecules that are in all living things. There are two kinds of nucleic acid: DNA and RNA. They are both polymers, because they consist of nucleotides connected by chemical bonds.

1 Location of DNA and RNA

- Two kinds of nucleic acids are found in a cell, namely DNA and RNA.
- DNA is found in the nucleus of eukaryotes and in the cytoplasm of prokaryotes.
- Extra-nuclear DNA is found in the chloroplasts and mitochondria in the cytoplasm of eukaryotes.
- RNA is found in the nucleus and cytoplasm.
- RNA is found in three forms: mRNA (messenger RNA); tRNA (transfer RNA) and rRNA (ribosomal RNA).

2 Structure of DNA and RNA

Both nucleic acids are made of building blocks (or monomers) called nucleotides.

Table 3 Structural differences between DNA and RNA

DNA	RNA
1. Double helix of two complementary strands)	1. Single stranded
2. The sugar group is deoxyribose.	2. The sugar is ribose.
3. Nitrogenous bases are adenine, thymine, cytosine and guanine.	3. Nitrogenous bases are adenine, uracil, cytosine and guanine.
4. Located in the nucleus, the chloroplast and mitochondrion	4. Located in the nucleus and cytoplasm
5. In the form of chromatin and chromosomes	5. In the form of mRNA, tRNA and rRNA
6. Fairly stable molecule	6. Very unstable molecule that breaks down rapidly

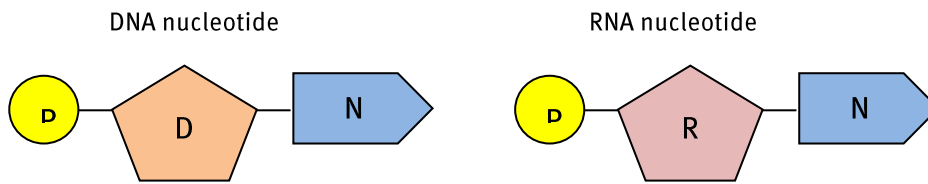

P – phosphate group
 D – deoxyribose sugar
 R – ribose sugar
 N – nitrogenous base (adenine, thymine, guanine, cytosine or uracil)

Figure 1 DNA and RNA nucleotides

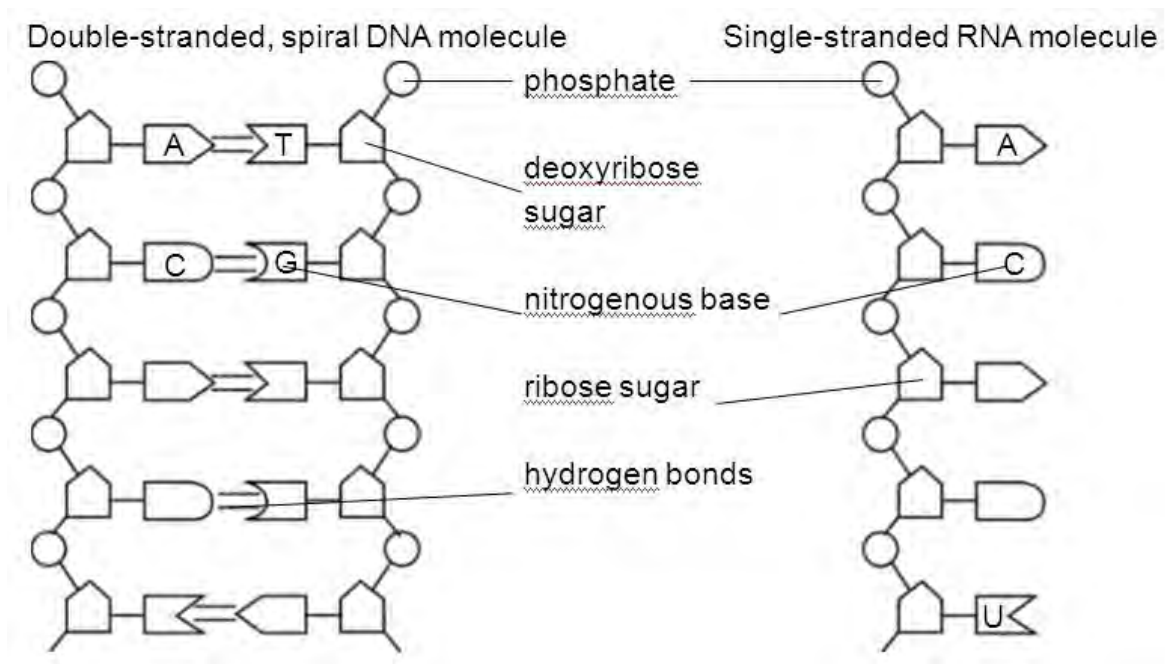

Figure 2 Structural differences between DNA and RNA molecules

3 Functions of DNA and RNA

There are five main functions of DNA, as follows:

- Carrying genetic instructions (codes)
- Maintaining structure and regulation of metabolism
- Protein synthesis
- Passing on hereditary material
- Replication and reproduction

There are three main functions of RNA, as follows:

- Manufacture and structure of rRNA (ribosomes)
- Transcription of the genetic DNA code into mRNA
- Translation of mRNA into proteins (polypeptides).

4 DNA replication

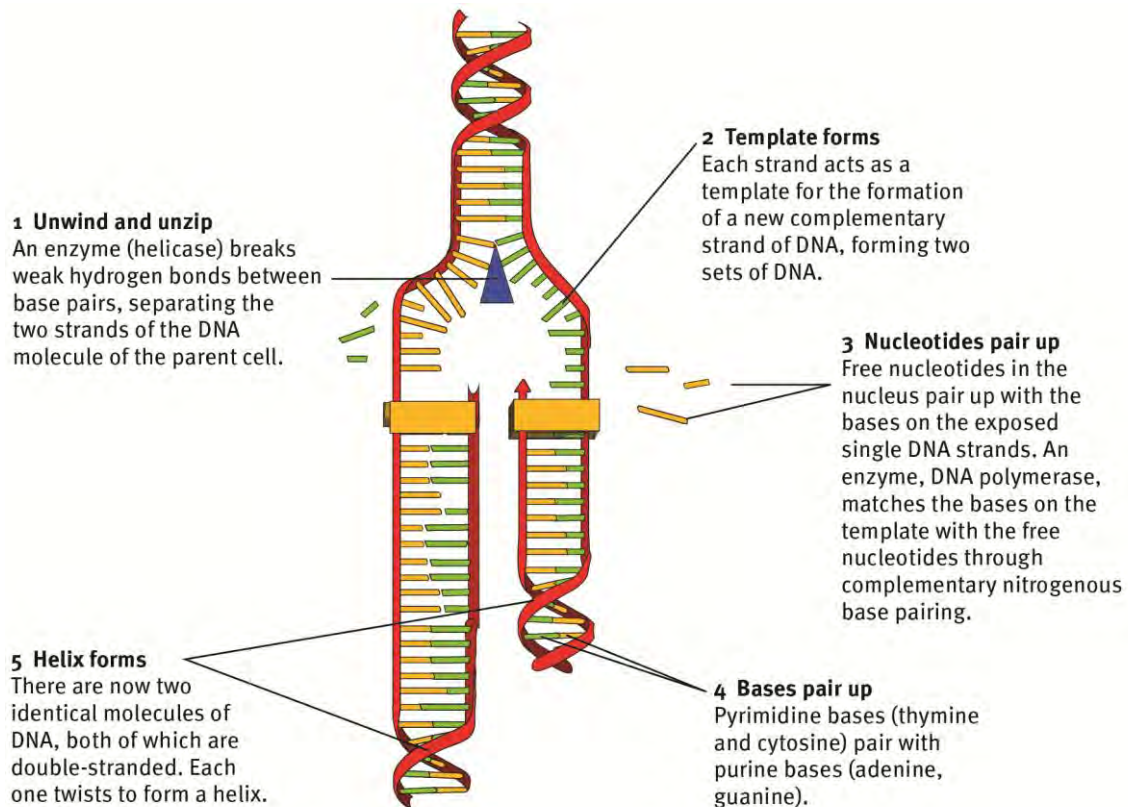

Figure 3 DNA replication

5 Transcription from DNA to mRNA

- The genetic code is a set of instructions coded for in a triplet base pair of DNA. This codes for matched, complementary triplet base pairs of mRNA.
- In mRNA the genetic code for the amino acid sequences of proteins is contained in the three mRNA triplet base pairs called codons.
- The tRNA molecules have complementary anti-codons and carry a specific amino acid to a specific position in a protein molecule.
- Depending on the nucleotides of the codon, different amino acids will be coded for.
- No codon codes for more than one amino acid.

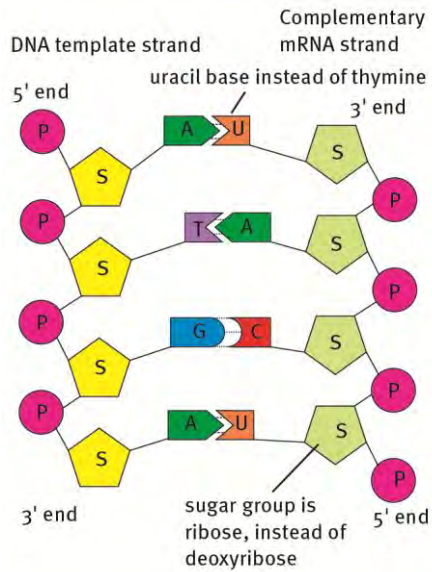

Figure 4 Protein synthesis: transcription

6 Translation from mRNA to protein

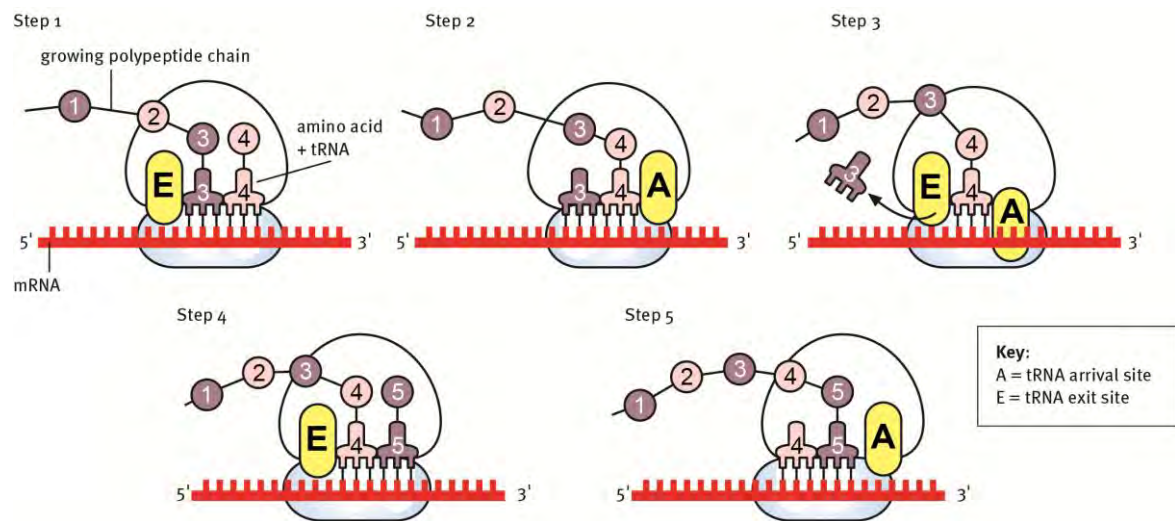

Figure 5 Protein synthesis: translation

7 Uses of DNA replication in biotechnology

DNA replication in biotechnology and genetic engineering is important for:

- Cloning cells in tissue culture
- Gene splicing to produce resistance to certain diseases, and to manufacture antibiotics, insulin, growth hormone and genetically modified organisms
- DNA profiling ('fingerprinting') and forensics
- Paternity and maternity testing (genetic lineage)
- Genetic counselling of parents to inform them about inheritable disorders and conditions.

Questions

Question 1

Various answers are provided to each question. Choose the correct answer. Only write the letter of the answer you select next to the question number.

- 1.1 The difference between a nucleic acid and a nucleotide is that ...
- A nucleic acids are monomers of nucleotides.
 - B nucleic acids are acidic while nucleotides are basis.
 - C nucleotides are monomers of nucleic acids.
 - D nucleotides are large while nucleic acids are small molecules. (2)
- 1.2 The dark threadlike structures inside the cell nucleus are known as the ...
- A chromosomes.
 - B nucleoli.
 - C centrosomes.
 - D centromeres. (2)
- 1.3 Where will the weak hydrogen bond break during replication? Between ...
- A the phosphate group and deoxyribose.
 - B cytosine and guanine.
 - C thymine and guanine.
 - D Ribose and thymine. (2)
- 1.4 If the sequence of the basis in part of a single DNA strand is adenine-guanine-adenine-cytosine, then the sequence of bases in the complementary strand will be ...
- A sugar – phosphate – sugar – phosphate.
 - B adenine – guanine – adenine – cytosine.
 - C uracil – cytosine – uracil – guanine.
 - D thymine – cytosine – thymine – guanine. (2)
- 1.5 The synthesis of protein in a cell takes place at the ...
- A centrioles.
 - B cytoplasm.
 - C ribosomes.
 - D chromosomes. (2)

- 1.6 Translation of a mRNA molecule with 48 nucleotides produces a polypeptide of ...
- A 3 amino acids.
 - B 12 amino acids.
 - C 16 amino acids.
 - D 48 amino acids. (2)
- 1.7 The diagram below shows the changes in cell mass and DNA mass during two cell cycles.

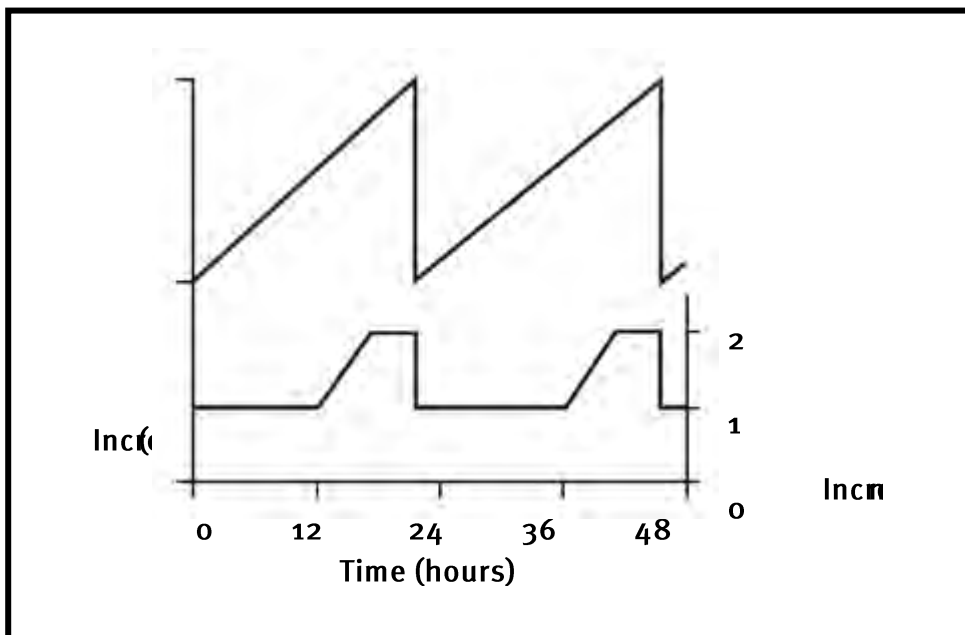

It can be concluded from the diagram that during the cell cycle ...

- A interphase is the longest phase.
- B the cell is dividing between 24 and 36 hours.
- C replication takes place between 0 and 12 hours.
- D cytokinesis takes place at 12 and 36 hours. (2)

Question 2

Give the correct term for each of the following statements.

- 2.1 The organelle which controls the structure, the metabolism of the cell, and contains the hereditary characteristics.
- 2.2 Threadlike structures which consist of DNA and proteins and carry the hereditary characteristics.

- 2.3 The monomers of nucleic acids.
- 2.4 The nucleic acid found only inside the nucleus.
- 2.5 The process during which the DNA molecule produces an exact copy of itself.
- 2.6 The type of nucleic acid which carries coded messages from the nucleus to the ribosomes.
- 2.7 Three consecutive nucleotides on a mRNA strand.
- 2.8 The nitrogen base found only in RNA.
- 2.9 The organelles in the cytoplasm where the proteins are synthesised.
- 2.10 The type of RNA that carries triplet anticodons.
- 2.11 tRNA carries these organic compounds to mRNA for proteins to be synthesised.
- 2.12 The compound in the nucleus that has the instructions about the correct order of the amino acids for each protein.
- 2.13 A technique that identifies the DNA from an individual.
- 2.14 Techniques where information in the nucleus of a cell is changed so that the cell acts differently.
- 2.15 The name of the sugar making up the mRNA molecule nucleoides.
- 2.16 The synthesis of a mRNA molecule on the pattern of one of the strands on the DNA molecule. (16)

Question 3

Match the words in Column A with the explanation in Column B.

Column A		Column B	
3.1	Adenine	A	Produced in the nucleus by transcription
3.2	Anticodon	B	The site of protein synthesis
3.3	Translation	C	Complementary base triplets in tRNA
3.4	Ribosomes	D	Complete set of genetic codes in a species
3.5	tRNA	E	Amino acids are arranged in a specific order
3.6	Transcription	F	Always joins to a guanine nucleotide
3.7	mRNA	G	Three successive nitrogen base in mRNA
3.8	Codon	H	Always joins to thymine or uracil nucleotide
3.9	Cytosine	I	Collects and delivers amino acids to ribosomes
3.10	Genome	J	Transfers genetic information from DNA to mRNA

(10)

Question 4

The diagrams alongside show the DNA finger prints from the scene of a crime and the DNA finger prints from three suspects. All three suspects have alibis (proof) that they could not have been present at the scene of the crime.

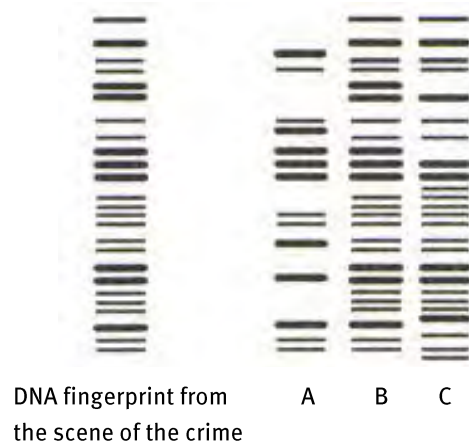

- 4.1 What conclusions could you make based on the DNA evidence in the diagrams?
- 4.2 Where could the DNA material have been obtained from the suspects?

Question 5

Study the diagram below illustrating protein synthesis and answer the questions that follow.

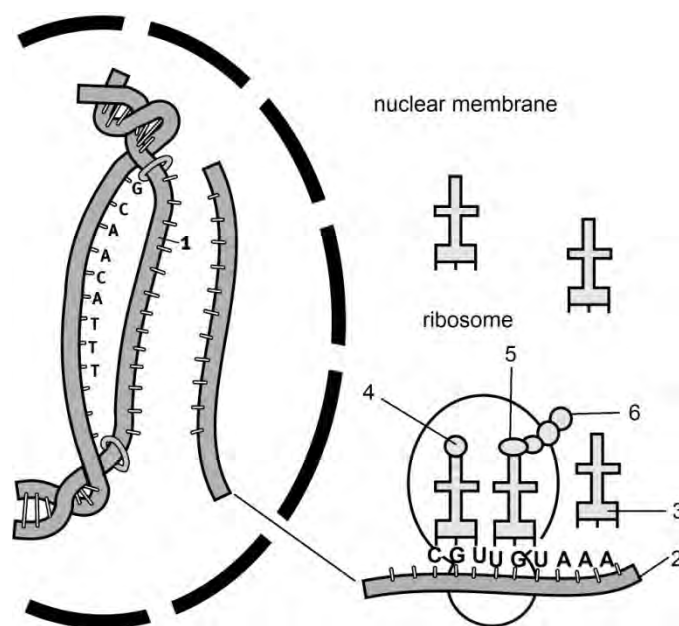

- 5.1 Name the molecule labelled 2. (1)
- 5.2 Using the letters of the genetic code, write down the complementary nitrogenous bases on strand 1 of the DNA double helix, starting from the top. (2)
- 5.3 The table on the next page shows the base triplets of tRNA (anticodons) that correspond to the different amino acids.

Base triplets (anticodons) of tRNA that correspond to different amino acids	
tRNA anticodons	amino acids
UGU	threonine
CGU	alanine
UUU	lysine
ACA	cysteine
GCA	arginine
GUU	glutamine
CUA	aspartate
CCA	glycine
AAA	phenylalanine

Use the diagram on the previous page and the table provided to do the following:

- 5.3.1 Write down the anticodon at 3. (1)
- 5.3.2 Name the amino acid at 5. (1)
- 5.3.2 State how the composition of the protein molecule would change if the base sequence of the first codon (from the left) of molecule 2 was UUU instead of CGU. (2)

Question 6

The diagram below shows the formation of a mRNA molecule using a single strand of DNA molecules as a template.

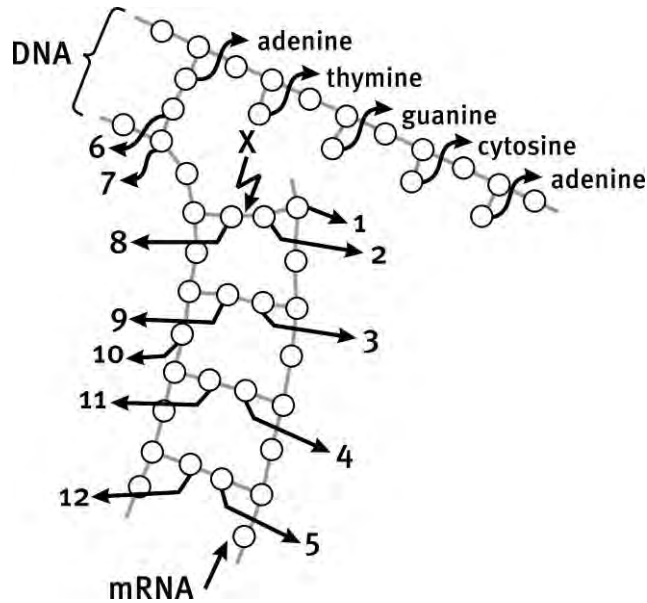

- 6.1 Identify the parts numbered 1 to 12. (12)
- 6.2 Name the chemical bond at X. (1)
- 6.3 What is the process in the diagram called? (1)
- 6.4 Where and when in the cell does the process shown in the diagram above occur? (2)
- 6.5 State FIVE differences between DNA and RNA. (10)
- 6.6 Explain clearly the differences between mRNA and tRNA. Use both structure and function to explain the differences. (4)

TOTAL MARKS: 75

Answers to Questions

Question 1

- | | | |
|-----|------|-----|
| 1.1 | C ✓✓ | (2) |
| 1.2 | A ✓✓ | (2) |
| 1.3 | B ✓✓ | (2) |
| 1.4 | D ✓✓ | (2) |
| 1.5 | C ✓✓ | (2) |
| 1.6 | C ✓✓ | (2) |
| 1.7 | A ✓✓ | (2) |

Question 2

- | | | |
|------|---------------------------------------|------|
| 2.1 | nucleus ✓ | |
| 2.2 | chromosomes ✓ | |
| 2.3 | nucleotides ✓ | |
| 2.4 | DNA ✓ | |
| 2.5 | replication ✓ | |
| 2.6 | mRNA ✓ | |
| 2.7 | codon ✓ | |
| 2.8 | uracil ✓ | |
| 2.9 | ribosomes ✓ | |
| 2.10 | tRNA ✓ | |
| 2.11 | amino acids ✓ | |
| 2.12 | mRNA ✓ | |
| 2.13 | DNA profiling / fingerprinting ✓ | |
| 2.14 | Genetic engineering / gene splicing ✓ | |
| 2.15 | ribose ✓ | |
| 2.16 | transcription ✓ | (16) |

Question 3

- 3.1 H ✓
- 3.2 C ✓
- 3.3 E ✓
- 3.4 B ✓
- 3.5 I ✓
- 3.6 J ✓
- 3.7 A ✓
- 3.8 G ✓
- 3.9 F ✓
- 3.10 D ✓ (10)

Question 4

- 4.1 B was at the scene of the crime ✓✓ (2)
- 4.2 blood, skin, hair ✓✓ (2)

Question 5

- 5.1 mRNA ✓ (1)
- 5.2 CGTTGTAAA ✓✓ (2)
 - 5.3.1 UUU ✓ (1)
 - 5.3.2 threonine ✓ (1)
 - 5.3.3 A different amino acid would be placed in the final protein at that position. ✓ Threonine would be placed in the protein instead of alanine. ✓ (2)

Question 6

- 6.1
 - 1 – ribose sugar ✓
 - 2 – uracil ✓
 - 3 – guanine ✓
 - 4 – cytosine ✓
 - 5 – adenine ✓
 - 6 – thymine ✓
 - 7 – deoxyribose sugar ✓

- 8 – adenine ✓
- 9 – cytosine ✓
- 10 – phosphate ✓
- 11 – guanine ✓
- 12 – thymine ✓ (12)
- 6.2 hydrogen bonds ✓ (1)
- 6.3 transcription ✓ (1)
- 6.4 In the nucleus ✓ During protein synthesis ✓ (2)
- 6.5 Structural differences between DNA and RNA

DNA	RNA
1. Double helix of two complementary strands) ✓	1. Single stranded ✓
2. The sugar group is deoxyribose ✓	2. The sugar is ribose ✓
3. Nitrogenous bases are: adenine, thymine, cytosine and guanine ✓	3. Nitrogenous bases are: adenine, uracil, cytosine and guanine ✓
4. Located in the nucleus, the chloroplast and mitochondrion ✓	4. Located in the nucleus and cytoplasm ✓
5. In the form of chromatin and chromosomes ✓	5. In the form of mRNA, tRNA and rRNA ✓
6. Fairly stable molecule ✓	6. Very unstable molecule that breaks down rapidly ✓

(any 5 pairs) (10)

- 6.6 mRNA – linear single strand ✓ acts as a template for the production of proteins. ✓
- tRNA – folded single strand ✓ transfers amino acids to mRNA for the production of proteins. ✓ (4)

TOTAL MARKS: 75

Overview

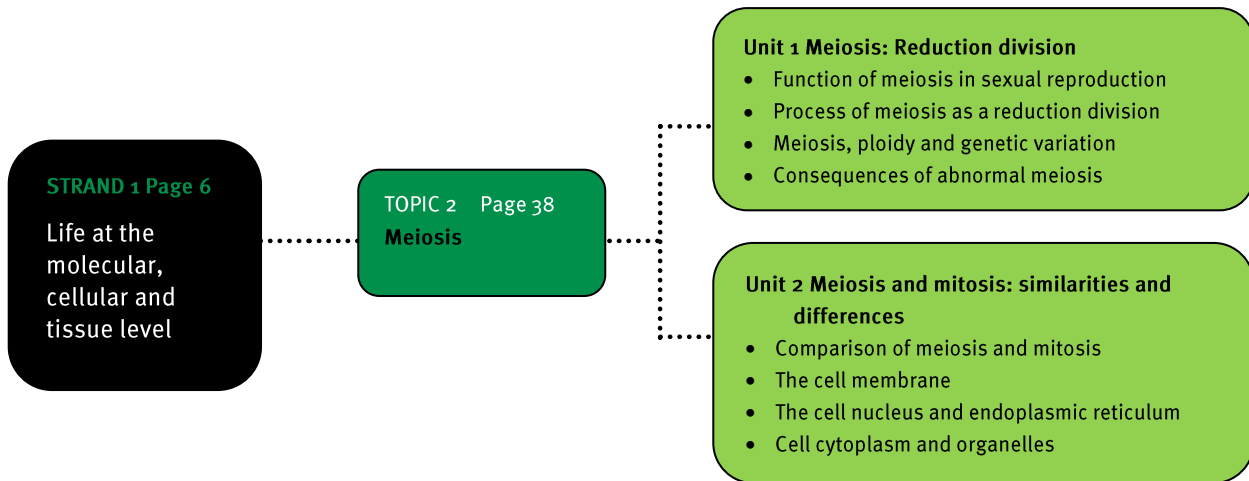

Units 1 and 2

1 Meiosis and sexual reproduction

- A diploid cell (or $2n$) has two complete sets of paired chromosomes, one from each parent.
- A haploid cell (or n) has a single set of unpaired chromosomes.
- During meiosis, a single diploid cell divides and produces four haploid reproductive cells. This is a type of division of the nucleus that reduces the chromosome number by half and is known as a reduction division.
- Meiosis is important in sexual reproduction, because it involves combining the genetic information of one parent with that of the other parent to produce a genetically unique individual.
- Genetic variation occurs through crossing over of genes called chiasmata formation and through separating the chromosomes from each other, called independent assortment.

2 Stages of meiosis

- Homologous chromosomes - Every cell has two of each chromosome – a homologous pair.
- They are similar in shape, position and information, but not identical to each other.
 - One chromosome in each pair is from the mother (maternal), the other from the father (paternal).
 - Paternal and maternal chromosomes may carry different alleles of the same gene, for example the gene for eye colour may be different.
 - Sister chromatids are replicated DNA from the same chromosome, maternal or paternal) and they are connected together at the centromere to form an X-shape.
- The result of DNA replication that happens during interphase of the cell cycle, before mitosis and meiosis, is the X-shaped chromosome, with two chromatids joined at the centromere. These chromosomes are present in the cell at the beginning of prophase I of meiosis.
- Meiosis occurs in two similar, but different stages: meiosis I and meiosis II. The behaviour of the chromosomes are quite different in each stage.
- The phases in meiosis 2 are the same as in mitosis, except that the cells are haploid and not diploid.

TOPIC 2

Meiosis

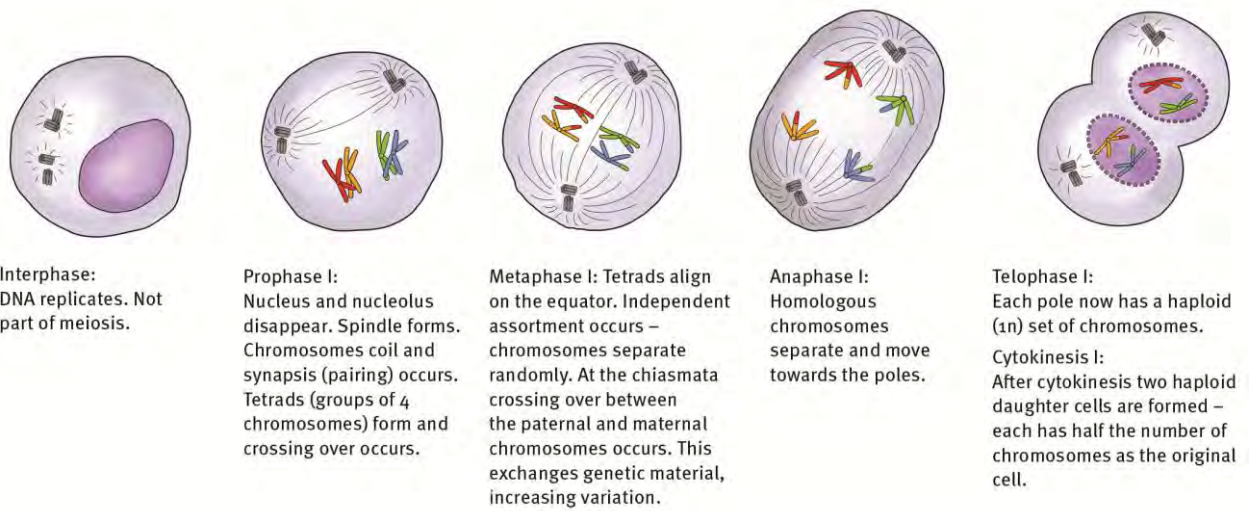

Figure 6 Meiosis I

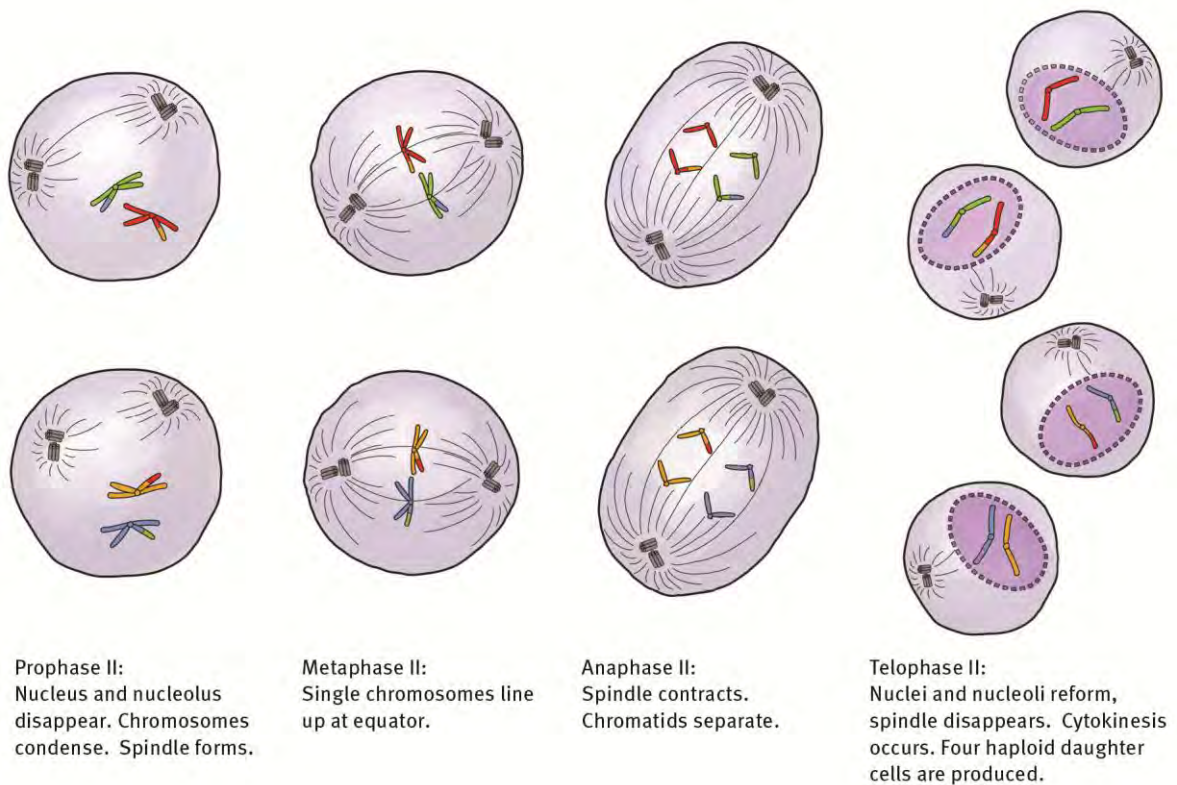

Figure 7 Meiosis II

3 Purpose of meiosis

- Gametes (sex cells) are produced through gametogenesis from germ cells of the reproductive organs: in animals, testes and ovaries; in plants, anthers and ovules. Male sex cells (spermatozoa) are produced by spermatogenesis. Female sex cells (ova) are produced by oogenesis.
- In some species, the organism alternates between a haploid and a diploid form during its life cycle – alternation of generations.
- Cells produced during meiosis are genetically different, resulting in greater genetic variety in the species, which allows the species to show adaptation. This occurs through crossing over (chiasmata formation) and random segregation.

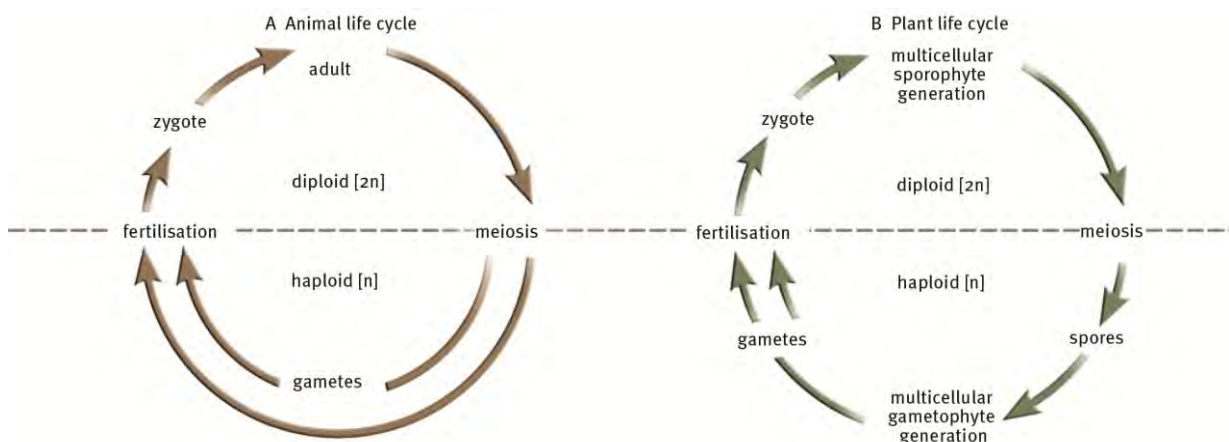

Figure 8 Meiosis II

4 Consequences of abnormal meiosis

- Aneuploidy results in incomplete chromosome separation in spermatozoa and ova; a problem caused in an organism by an extra or missing chromosome. For example Klinefelter syndrome is an extra sex chromosome giving 47 chromosomes, XXY. Down's syndrome is Trisomy 21.
- Polyploidy, when cells have more than two complete sets of chromosomes, can also occur in some organisms.
- These meiotic disorders can cause male infertility, spontaneous abortions and can affect offspring in various other ways.

4.1 Down's syndrome

- Somatic (body) cells with 47 chromosomes – an extra chromosome 21. Down's syndrome is also called Trisomy 21. It results from incomplete chromosome separation (called non-disjunction) in meiosis.
- A few external factors like radiation can also cause Trisomy 21, through mutations.

- In women, this disorder occurs in the first maternal meiotic division, but some disjunctions occur in the second division, during development of the embryo.
- In men, a small number of Trisomy 21 cases show non-disjunction in the first paternal meiotic division, and a similar number in the second paternal meiotic division.

5 Mitosis

Mitosis consists of the phases prophase, metaphase, anaphase and telophase.

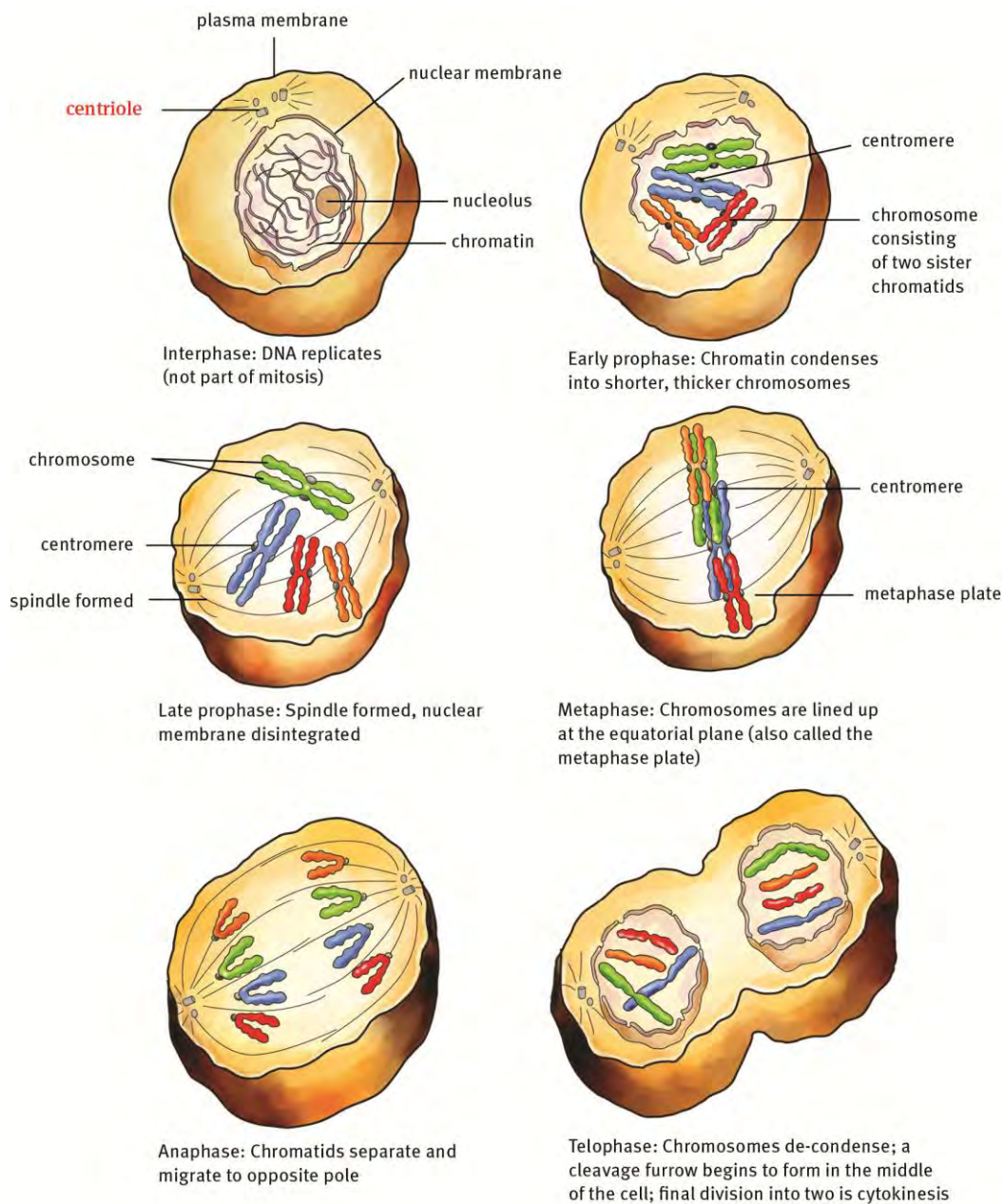

Figure 9 Mitosis

6 Similarities and differences

- Both mitosis and meiosis are important cell division processes in living organisms.
- They each:
 - have a particular purpose or function
 - occur in particular areas of multi-cellular organisms
 - occur at particular times in the life cycle of single-celled organisms.

Table 4 Differences between mitosis and meiosis

Mitosis	Meiosis
1. Occurs in somatic cells (body cells)	1. Occurs in reproductive cells
2. Dividing cells haploid or diploid	2. Dividing cells diploid
3. One division of chromosomes (chromatids)	3. Two divisions of chromosomes: <ul style="list-style-type: none"> • separation of homologous chromosomes • division of chromosomes (chromatids)
4. No pairing of homologous chromosomes or crossing over (chiasmata formation)	4. Pairing of homologous chromosomes and crossing over (chiasmata formation)
5. One nuclear division (the metaphase)	5. Two nuclear divisions (metaphases I and II)
6. Cytokinesis occurs once only	6. Cytokinesis may take place once (simultaneously) or twice (consecutively)
7. Two diploid daughter cells produced	7. Four haploid daughter cells produced
8. Replication division occurs; number of chromosomes in mother cell maintained	8. Replication and reduction divisions occur; number of chromosomes in mother cell replicated and halved
9. Original traits of chromosomes maintained in daughter cells	9. Chromosomal traits altered, due to 'crossover'; recombination of genes
10. Daughter cells identical to each other, and also to original mother cell	10. Daughter cells differ from one another, and from original mother cell
11. Growth and repair	11. Gamete production for sexual reproduction, and regulating chromosome number in the life cycle.

Questions

Question 1

Various answers are provided to each question. Choose the correct answer. Only write the letter of the answer you select next to the question number.

- 1.1 Meiosis occurs in the ...
A zygote of humans.
B bone marrow of humans.
C sorus of ferns.
D roots of plants. (2)
- 1.2 Trisomy 21 is also known as ...
A Down's syndrome.
B Klinefelter syndrome.
C albinism.
D haemophilia. (2)
- 1.3 The diagram below represents ...

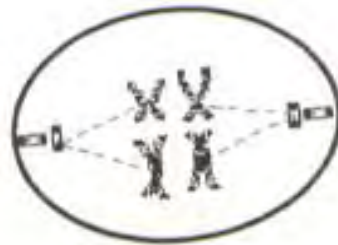

- A metaphase I of meiosis.
B metaphase II of meiosis.
C metaphase of mitosis.
D none of the above. (2)

Questions 1.4 and 1.5 refer to the following information.

A queen bee can lay both fertilised and unfertilised eggs. Fertilised eggs develop directly into diploid females and unfertilised eggs develop directly into haploid males. The following diagram shows the formation of gametes in male and female bees.

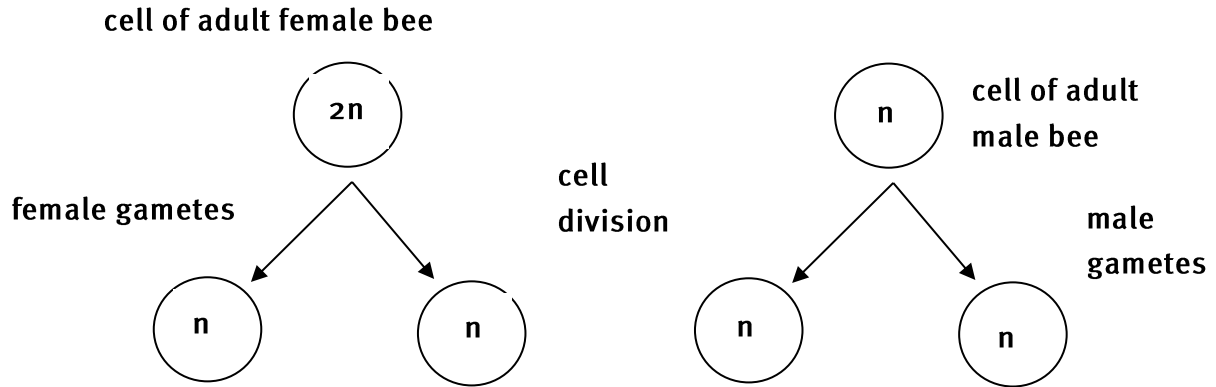

- 1.4 The type of division that forms the male gametes in the honey bee is ...
- A meiosis.
 - B mitosis.
 - C reduction division.
 - D the same as occurs in human males. (2)
- 1.5 In the formation of the female honey bee gametes, variation is caused by ...
- A crossing over.
 - B DNA replication.
 - C transcription.
 - D translation. (2)

Question 2

Give the correct term for each of the following statements.

- 2.1 The point at which two chromatids of a chromosome are joined together.
- 2.2 Abnormal meiosis leading to Down's Syndrome.
- 2.3 A human genetic condition resulting from having an extra chromosome 21.
- 2.4 Crossing over and exchange of genes between maternal and paternal pairs.
- 2.5 A set of male and female chromosomes carrying genes for the same features.

(5)

Question 3

Indicate whether each of the statements in COLUMN 1 applies to A only, B only, both A and B or none of the items in COLUMN 2. Write A only, B only, both A and B, or none.

	COLUMN 1	COLUMN 2
3.1	Change in the genetic make-up of an organism	A: Mutation B: Multiple alleles
3.2	Introduces variation within a species	A: Crossing over during meiosis B: Random assortment of chromosomes during meiosis
3.3	Results when a diploid cell divides during meiosis	A: Four diploid cells B: Four haploid cells
3.4	Chromatids pulled to the poles of a cell	A: Anaphase of mitosis B: Anaphase 2 of meiosis
3.5	Duplication of DNA in a cell	A: Interphase B: Prophase
3.6	Production of gametes in higher animals	A: Mitosis B: Meiosis
3.7	Growth and repair	A: Meiosis B: Mitosis

(7)

Question 4

The diagrams of animal cells below show different stages of cell division. Study them carefully and answer the questions which follow. (There are four chromosomes in a somatic cell.)

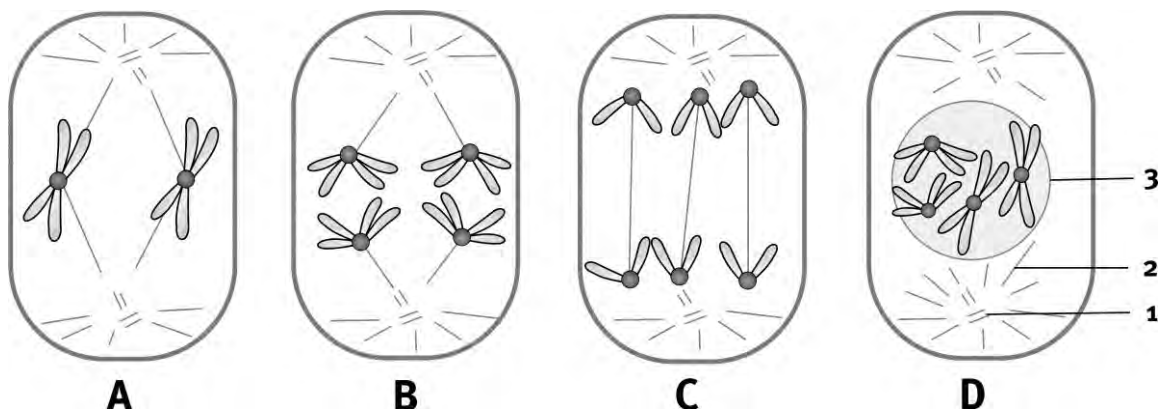

Some of the above diagrams represent stages of meiosis.

4.1 Write down the letters in the correct sequence as the phases of meiosis. (3)

4.2 Identify the structures numbered 1, 2 and 3. (3)

Some of the diagrams above show the formation of haploid cells.

4.3 Write down the letters of these diagrams. (2)

4.4 Name ONE place in a moss plant where you would expect meiosis to take place. (2)

Question 5

Reduction division or meiosis occurs in the ovaries and testes to produce gametes or sex cells. Give a detailed explanation of the process of meiosis in animal cells. Begin at interphase of the first meiotic division and end at telophase II. (30)

Question 6

The diagram below shows the nucleus of a mammalian cell during cell division.

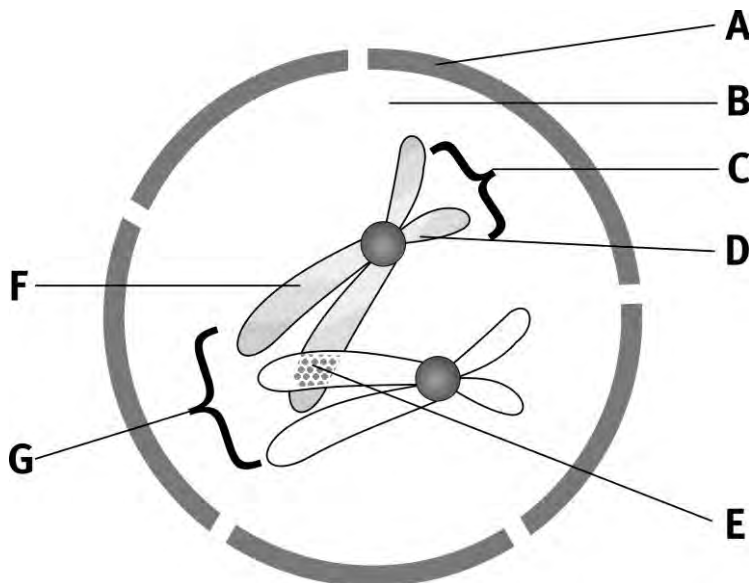

6.1 Provide labels for structures A to G. (7)

6.2 Which type of cell division is being represented in this diagram? (1)

6.3 How many chromosomes are visible? (1)

6.4 Which phase of cell division is being represented? (2)

Question 7

Study the accompanying diagram and answer the question that follow.

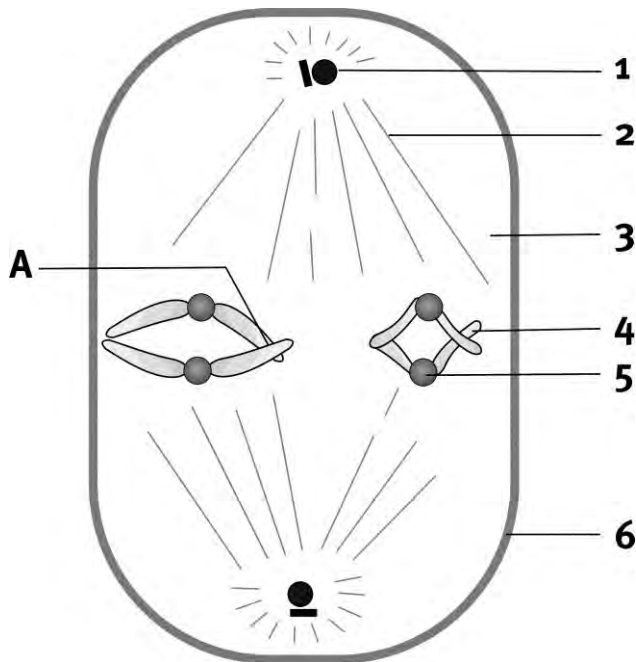

- 7.1 Name the meiotic phase represented in this diagram. Give TWO reasons for your answer. (3)
- 7.2 Provide labels for the parts numbered 1 to 6. (6)
- 7.3 How many chromosomes are visible in the diagram? (2)
- 7.4 Is this cell haploid or diploid? Give a reason for your answer. (2)
- 7.5 Name the process that is taking place in the part labelled A. (2)
- 7.6 Give TWO important functions of the process taking place at A. (2)

TOTAL MARKS: 90

Answers to Questions

Question 1

- | | | |
|-----|------|-----|
| 1.1 | C ✓✓ | (2) |
| 1.2 | A ✓✓ | (2) |
| 1.3 | A ✓✓ | (2) |
| 1.4 | B ✓✓ | (2) |
| 1.5 | A ✓✓ | (2) |

Question 2

- | | | |
|-----|---------------------------|-----|
| 2.1 | centromere ✓ | |
| 2.2 | aneuploidy / trisomy 21 ✓ | |
| 2.3 | Down's syndrome ✓ | |
| 2.4 | Chiasmata formation ✓ | |
| 2.5 | homologous chromosomes ✓ | (5) |

Question 3

- | | | |
|-----|----------------|-----|
| 3.1 | A only ✓ | |
| 3.2 | Both A and B ✓ | |
| 3.3 | B only ✓ | |
| 3.4 | Both A and B ✓ | |
| 3.5 | A only ✓ | |
| 3.6 | B only ✓ | |
| 3.7 | B only ✓ | (7) |

Question 4

- | | | |
|-----|--|-----|
| 4.1 | B ✓, A ✓, C ✓ | (3) |
| 4.2 | 1 – centriole ✓
2 – spindle fibre ✓
3 – nuclear membrane ✓ | (3) |
| 4.3 | A ✓ and C ✓ | (2) |
| 4.4 | In the sporophyte capsule ✓✓ | (2) |

Question 5

- Interphase ✓ – DNA is duplicated ✓ and becomes visible as chromosomes. ✓
- Prophase I ✓ – Nucleus and nucleolus disintegrate, spindle forms, chromosomes coil and synapsis (pairing) occurs ✓; tetrads (groups of 4 chromosomes) form and crossing over occurs between homologous chromosomes. ✓
- Metaphase I ✓ – Tetrads align on the equator ✓; independent assortment occurs – chromosomes separate randomly. ✓
- Anaphase I ✓ – Homologous chromosomes separate ✓ and move towards the poles. ✓
- Telophase I ✓ – Each pole ✓ now has a haploid (1n) ✓ set of chromosomes.
- Cytokinesis I ✓ – After cytokinesis two haploid daughter cells are formed ✓ – each has half the number of chromosomes as the original cell. ✓
- Prophase II ✓ – Same as prophase in mitosis I ✓; nucleus and nucleolus disintegrate; chromosomes condense; spindle forms. ✓
- Metaphase II ✓ – Single chromosomes ✓ line up at equator. ✓
- Anaphase II ✓ – Same as anaphase in mitosis; ✓ chromatids separate. ✓
- Telophase II ✓ – Same as telophase in mitosis; ✓ nuclei and nucleoli reform, spindle disappears; cytokinesis occurs; four haploid daughter cells are produced. ✓ (30)

Question 6

- 6.1 A – double nuclear membrane / envelope ✓
 B – nucleoplasm ✓
 C – chromosome ✓
 D – centromere ✓
 E – chiasmata formation / crossing over ✓
 F – chromatid ✓
 G – homologous chromosomes ✓ (7)
- 6.2 Meiosis ✓ (1)
- 6.3 Two ✓ (1)
- 6.4 Prophase I ✓ of meiosis ✓ (2)

Question 7

- 7.1 Metaphase I of meiosis ✓
Homologous pairs of chromosomes are found on the equator ✓
Spindle fibres attach to chromosomes and not chromatids ✓ (3)
- 7.2 1 – centriole ✓
2 – spindle fibre ✓
3 – cytoplasm ✓
4 – chromatid of chromosome ✓
5 – centromere ✓
6 – cell membrane / plasmalemma ✓ (6)
- 7.3 Four ✓✓ (2)
- 7.4 Diploid ✓ There are two pairs of homologous chromosomes ✓ (2)
- 7.5 Crossing over / chiasmata formation ✓✓ (2)
- 7.6 Production of haploid gametes ✓ Genetic variation ✓ (2)

TOTAL MARKS: 90

Overview

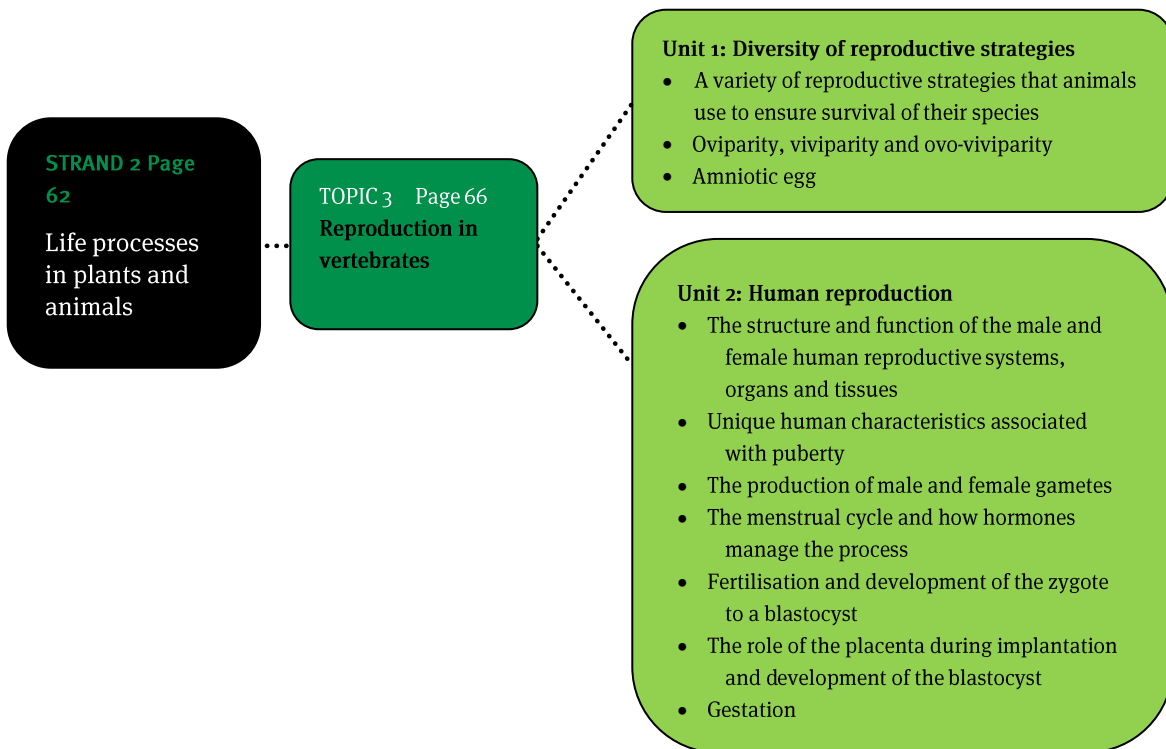

Units 1 and 2

1 Oviparous, ovoviviparous and viviparous animals

Table 5 Comparison of different modes of giving birth in animals

Oviparous animals	Ovoviviparous animals	Viviparous animals
<ul style="list-style-type: none"> Internal or external fertilisation 	<ul style="list-style-type: none"> Internal fertilisation 	<ul style="list-style-type: none"> Internal fertilisation
<ul style="list-style-type: none"> Eggs laid outside the body 	<ul style="list-style-type: none"> Eggs kept inside the body 	<ul style="list-style-type: none"> Eggs kept inside the body
<ul style="list-style-type: none"> Eggs protected by a gelatinous mass in frogs, a leathery shell in reptiles and a hard, brittle calcareous shell in birds Protective membranes 	<ul style="list-style-type: none"> Eggs protected by a soft shell inside the female body Protective membranes 	<ul style="list-style-type: none"> Eggs protected by the female body, ovary, follicle cells, membranes and the uterus
<ul style="list-style-type: none"> Development of embryo occurs in the egg which is outside the organism's body 	<ul style="list-style-type: none"> Development of embryo occurs in the egg, which is inside the female's body 	<ul style="list-style-type: none"> Development of embryo occurs in the uterus It is fed through the placenta which is inside the female body
<ul style="list-style-type: none"> Embryo gets its food from the egg yolk, not from the mother 	<ul style="list-style-type: none"> Embryo gets its food from the egg yolk, not from the mother 	<ul style="list-style-type: none"> Embryo embeds itself in the wall of the uterus and gets its food from the mother, through the umbilical cord
<ul style="list-style-type: none"> Egg hatches outside of the body Egg may or may not have parental care 	<ul style="list-style-type: none"> Egg hatches inside of the body just before birth; live young born May or may not have parental care 	<ul style="list-style-type: none"> Gestation (pregnancy) followed by birth on complete development of embryo Live young born; with parental care: suckling
<p>Examples: Round worms, molluscs, insects, crustaceans, arachnids, fish, amphibians, reptiles, birds, few mammals</p>	<p>Examples: Some lizards and snakes, some fish</p>	<p>Examples: Mammals</p>

2 The amniotic egg

B Egg with developing chick

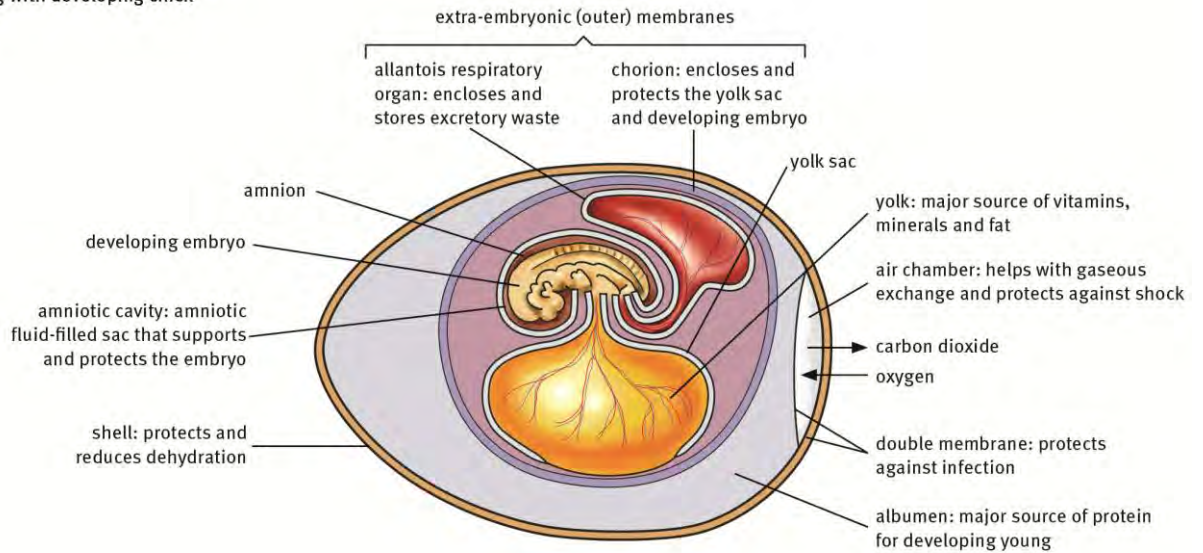

Figure 10 Amniotic chicken egg

3 Precocial and altricial development

Table 6 Comparison of precocial and altricial development

Precocial development	Altricial development
<ul style="list-style-type: none"> Eggs contain about 40% yolk 	<ul style="list-style-type: none"> Eggs contain about 25% yolk
<ul style="list-style-type: none"> Hatched with eyes open 	<ul style="list-style-type: none"> Hatched with eyes closed
<ul style="list-style-type: none"> Covered with down/fur 	<ul style="list-style-type: none"> Little or no down/fur
<ul style="list-style-type: none"> Leave the nest within two days 	<ul style="list-style-type: none"> Unable to leave the nest until independent
<ul style="list-style-type: none"> Follow parents and learn how to feed straight after birth 	<ul style="list-style-type: none"> Fed by parents until independent
Examples: Ducks, chicks, game birds, grouse Hoofed animals: buck, giraffe, zebra, cattle	Examples: Perching birds: sparrows, pigeons, starlings Marsupials, mammals: carnivores and rodents

4 The male reproductive system

- External genitals – scrotum and penis
- Essential organs – a pair of sex glands called the testes (gonads), which produce the male sex cells called spermatozoa (sperm)
- Accessory organs – are glands (seminal vesicles, prostate gland and Cowper’s gland), sperm ducts and the penis
- Additional glands provide secretions to nurture sperm:
 - seminal vesicles (two)
 - Cowper’s glands (bulbo-urethral glands) (two)
 - prostate gland.

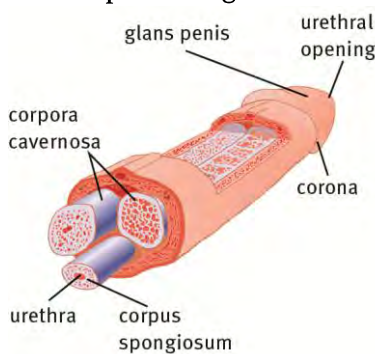

Figure 11 Structure of a penis

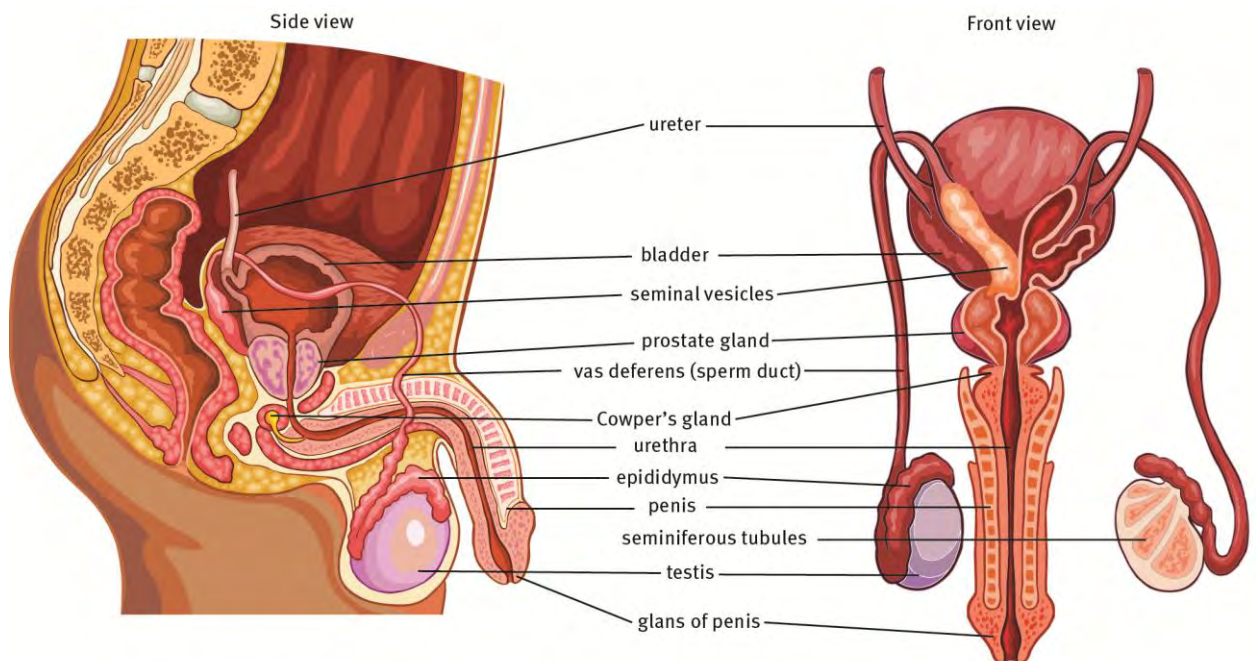

Figure 12 Structure of the male reproductive system

5 The female reproductive system

- External genitals – the vulva made of four labia and the clitoris
- Essential organs – a pair of sex glands called the ovaries (gonads), which produce female sex cells called ova (singular = ovum)
- Accessory organs are:
 - Fallopian tubes: two ducts going from near the ovaries to the uterus, to carry eggs
 - uterus (womb): a modified duct to house and protect the developing embryo and foetus; with its cervix
 - vagina: a duct that assists in copulation and is the birth canal leading from the uterus
 - mammary glands: glands in the breasts for lactation and feeding young.

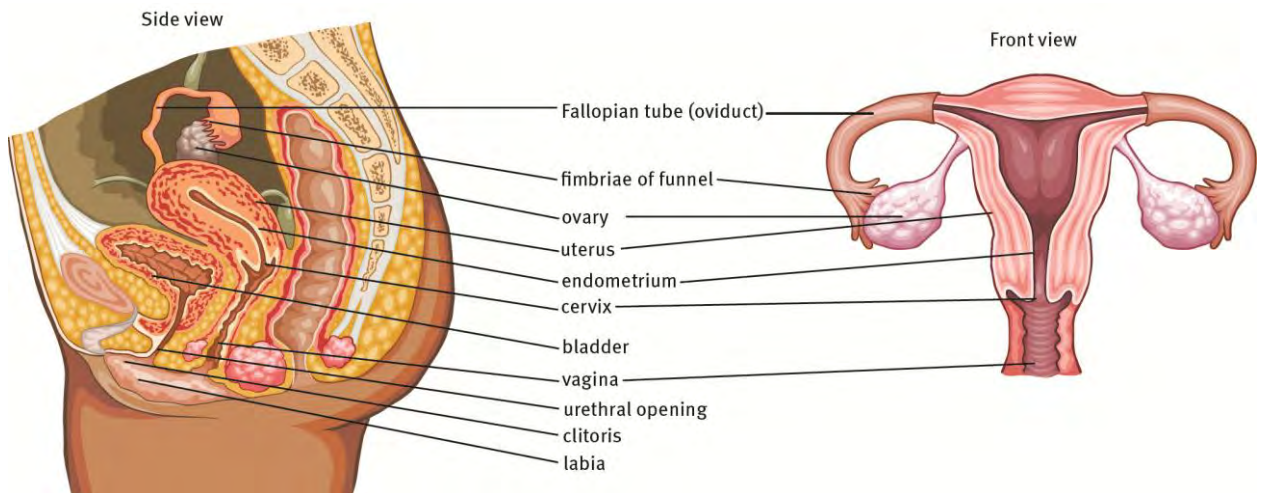

Figure 13 Structure of the female reproductive system

6 The ovaries

- Ovarian follicles – contain oocytes in the ovary
- Oocytes – cells that produce haploid ova through meiosis
- Graafian follicles – large, mature ovarian follicles
- Corpus luteum – remains of a follicle which has released an ovum and is degenerating.

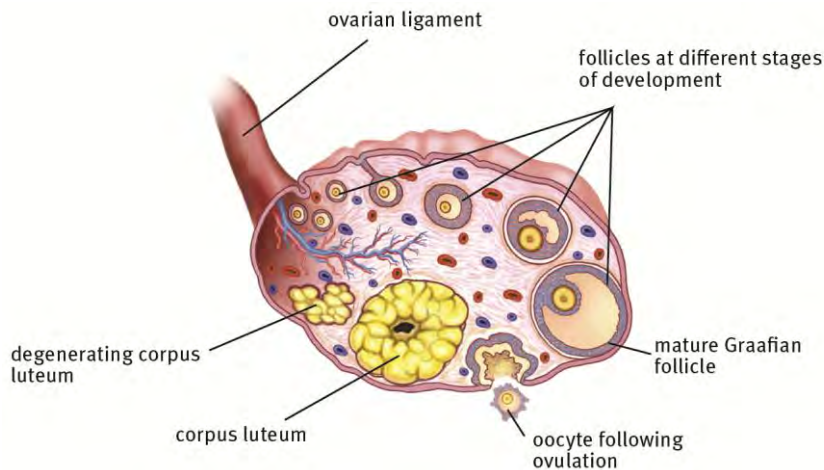

Figure 14 Structure of the ovary

7 Puberty in males and females

- Puberty is the time of life when a person becomes sexually mature.
- Puberty starts when the hypothalamus in the brain starts releasing a hormone called gonadotropin-releasing hormone (GnRH).
- Puberty starts in males when GnRH signals stimulate the anterior pituitary gland to secrete:
 - follicle-stimulating hormone (FSH), which stimulates the testes to produce sperm, and
 - luteinising hormone (LH), which stimulates the testes to produce testosterone.
- Puberty starts in females when GnRH signals stimulate the anterior pituitary gland to secrete:
 - follicle-stimulating hormone (FSH), which stimulates a follicle in the ovary to produce oestrogen, and
 - luteinising hormone (LH), which stimulates the corpus luteum in the ovary to produce progesterone.

8 Secondary sexual characteristics in males and females

- In males, testosterone causes the development of these secondary sexual characteristics in the body:
 - rapid increase in height, size and strength of muscles
 - development and functioning of the prostate gland, seminal vesicles and other male accessory glands
 - voice deepens
 - hair grows in the pubic area, under the armpits and on the face
 - the testes and penis increase in size.

- In females, oestrogen causes the following developmental changes in the body during pregnancy:
 - rapid increase in height and breast development
 - hair growth in the pubic area and under the armpits
 - increase in size of the vagina
 - uterine and endometrial growth
 - onset of menstruation
 - increase in body fat.
- Progesterone is not responsible for secondary sexual characteristics but is important for:
 - making oestrogen
 - promoting survival and development of the embryo and foetus
 - maintaining the thickness of the endometrium lining during pregnancy.

9 Gametogenesis in males and females

Table 7 Comparison of spermatogenesis and oogenesis

Spermatogenesis	Oogenesis
<ul style="list-style-type: none"> • Takes place in testes of males 	<ul style="list-style-type: none"> • Takes place in ovary of females
<ul style="list-style-type: none"> • Meiosis occurs continuously in mitotically-dividing stem cell population 	<ul style="list-style-type: none"> • Meiosis initiated once. Oocyte meiotic development stops at prophase I of meiosis in foetus, until puberty; then stops at metaphase II of meiosis; on fertilisation meiotic division completed
<ul style="list-style-type: none"> • Meiosis completed in days or weeks 	<ul style="list-style-type: none"> • Completion of meiosis delayed for months or years
<ul style="list-style-type: none"> • Meiosis and differentiation proceed continuously. • Differentiation of gamete occurs while haploid (after meiosis ends); involves metamorphosis of sperm cells – spermatogenesis. 	<ul style="list-style-type: none"> • Differentiation of gamete occurs while diploid (in first meiotic prophase); no metamorphosis stage found
<ul style="list-style-type: none"> • Produces small, motile spermatozoa 	<ul style="list-style-type: none"> • Produces large, non-motile, spherical ova with more food reserves and cytoplasm
<ul style="list-style-type: none"> • Four gametes produced from each meiotic division 	<ul style="list-style-type: none"> • Only one gamete produced from each meiosis division as unequal cytokinesis leads to polar body formation
<ul style="list-style-type: none"> • Occurs continuously from puberty to death 	<ul style="list-style-type: none"> • Continues in females at puberty until menopause
<ul style="list-style-type: none"> • Takes 70 days for mature sperm to be produced in males 	<ul style="list-style-type: none"> • Occurs monthly

<ul style="list-style-type: none"> • FSH increases activity of Sertoli cells • involved in spermatogenesis 	<ul style="list-style-type: none"> • FSH responsible for choice of primary oocyte and production of oestrogen
<ul style="list-style-type: none"> • LH stimulates Leydig cells to secrete testosterone 	<ul style="list-style-type: none"> • LH in females stimulates ovulation and maturation of the Graafian follicle

10 The menstrual cycle

The ovarian and uterine cycles are associated with menstruation.

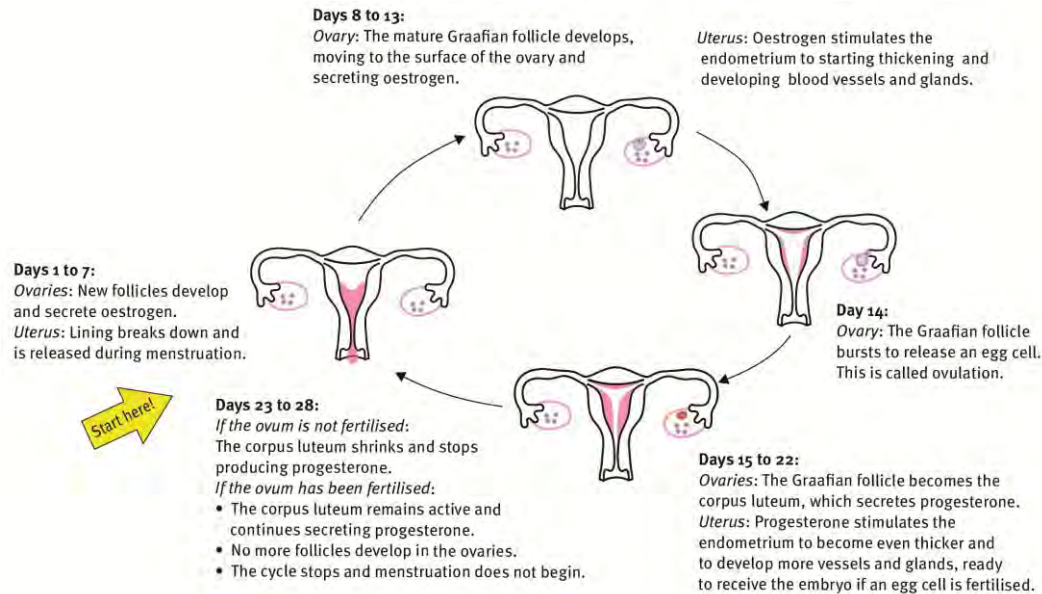

Figure 15 The menstrual cycle

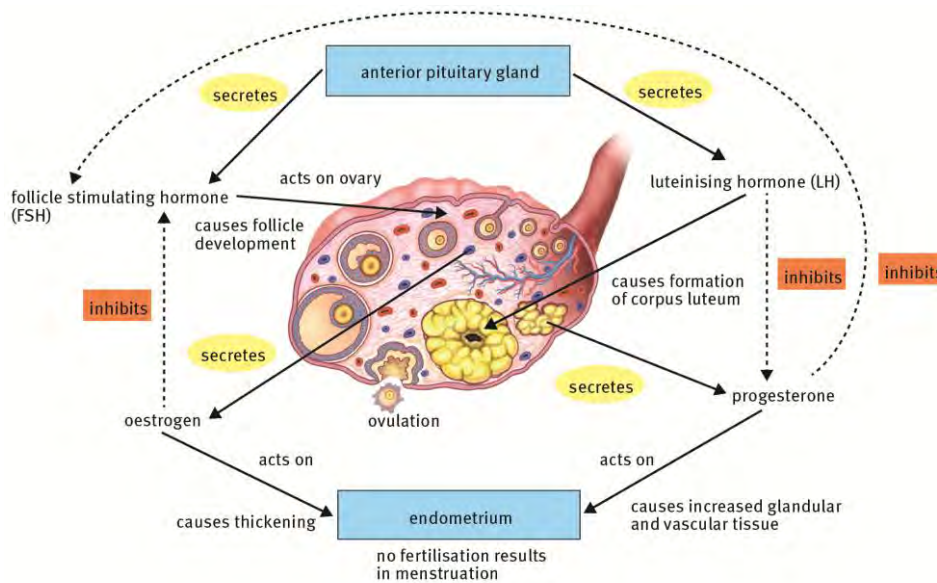

Figure 16 Hormonal control of the menstrual cycle

11 Fertilisation and prenatal development

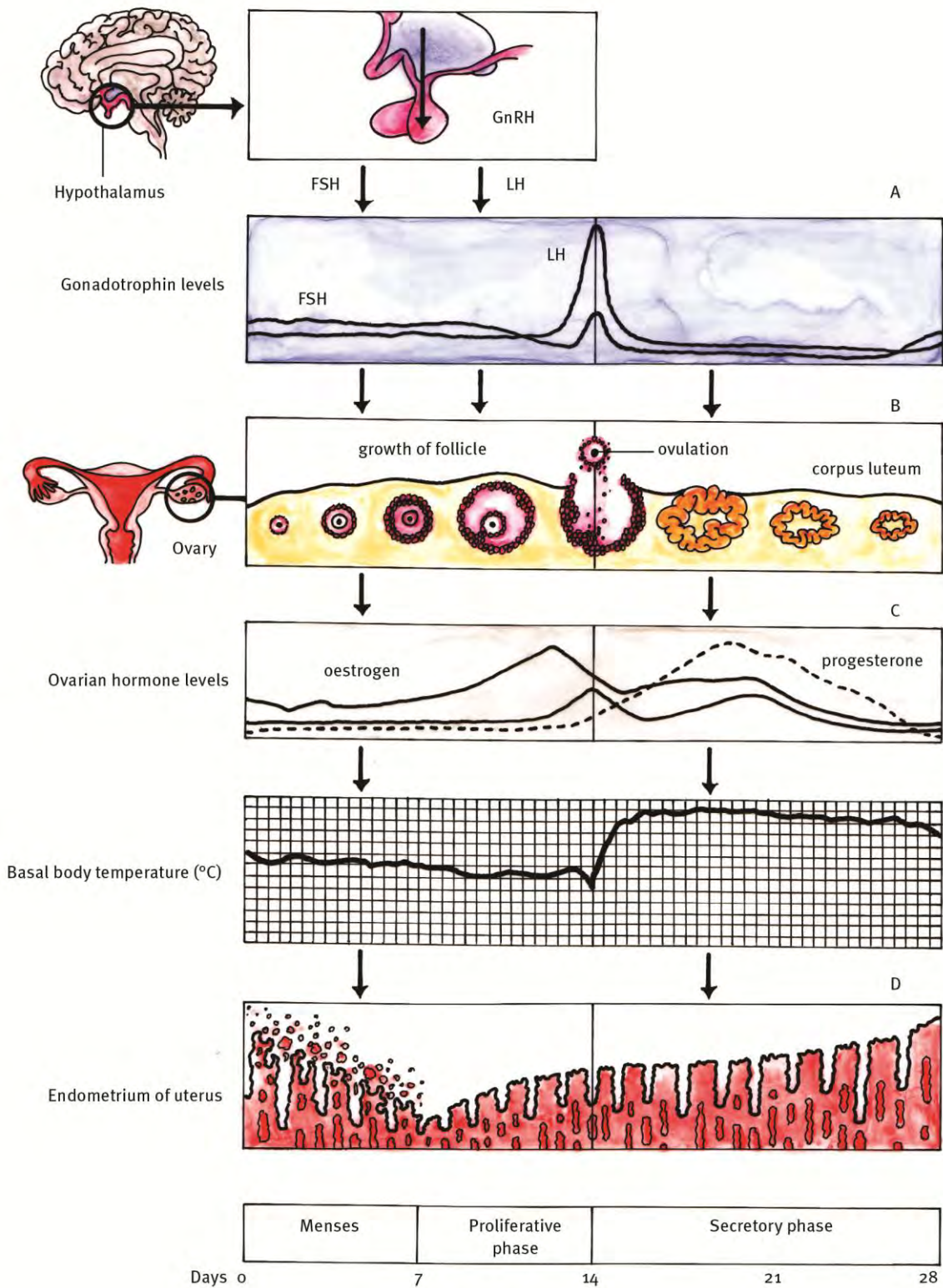

Figure 17 Fertilisation and implantation

12 The placenta and umbilical cord

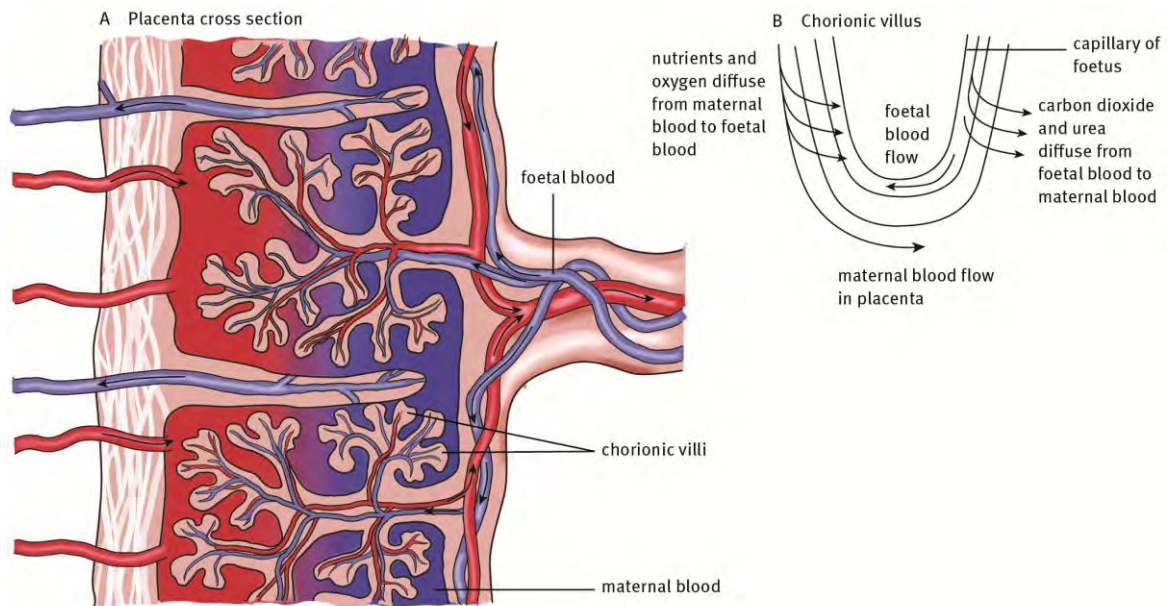

Figure 18 Structure and function of the placenta

- The embryos of reptiles, birds and mammals develop inside a fluid-filled amniotic membrane, associated with other membranes.
- The extra-embryonic membranes do not form part of the embryo.
- They are:
 - The amnion – forms the fluid-filled amniotic sac to protect the embryo from physical shocks and prevent it drying out
 - The chorion – protects the embryo and other membranes and forms the placenta
 - The allantois – helps to form the umbilical cord
 - The yolk sac – stores food; is the first site of blood cell formation.
- The zygote becomes an embryo and then develops into a foetus through tissue and organ differentiation.
- During development the foetus is anchored, obtains nutrients and removes waste through the placenta and umbilical cord.
- The placenta develops from both embryonic and maternal tissue: the chorion and the tissues of the mother's uterus.
- It brings the mother's circulatory system and the embryo's circulatory system into close but not direct contact with each other.

- The placenta forms an effective exchange surface because it:
 - has a large surface area due to its folds
 - it is moist to help exchange of substances
 - has a rich supply of blood capillaries to transport nutrients and waste
 - is made of a thin layer of cells that allow easy exchange of substances
 - lets maternal and foetal blood flow in opposite directions to maximise nutrient and waste exchange.
- The amnion is a thin protective membrane that grows around the embryo, contains amniotic fluid that allows the foetus to move freely, maintains a constant temperature around the foetus, and acts as a shock absorber.

13 Gestation and childbirth

- The period of development of the embryo from fertilisation to birth is called gestation.
- In humans the nine month pregnancy (40 weeks) consists of three-month developmental periods, called trimesters.
- Parturition (childbirth) occurs about 40 weeks after the last menstrual period.

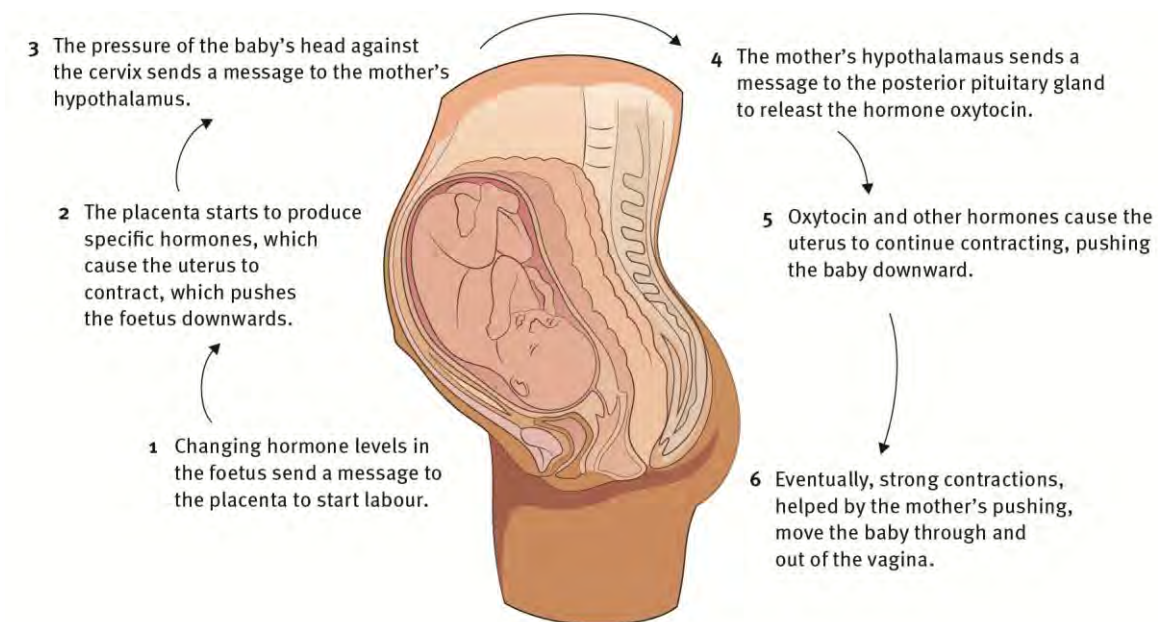

- The foetus turns upside down and lies with its head near the cervix.

Figure 19 Hormonal control of childbirth

Questions

Question 1

Various answers are provided to each question. Choose the correct answer. Only write the letter of the answer you select next to the question number.

- 1.1 Which of the following male and female structures are LEAST alike in function?
 A Seminiferous tubules – vagina
 B Spermatogonia – oogonia
 C Testes – ovaries
 D Vas deferens – Fallopian tube (oviduct) (2)
- 1.2 Stimulate mammary glands to produce milk:
 A prolactin
 B oxytocin
 C progesterone
 D oestrogen (2)
- 1.3 Controls secretion of sex hormones:
 A FSH
 B LH
 C TSH
 D Testosterone (2)
- 1.4 The correct sequence of events during spermatogenesis is ...
 A Germinal epithelial cell → Spermatozoa → Spermatogonia
 B Germinal epithelial cells → Spermatids → Spermatozoa
 C Spermatozoa → Spermatids → Spermatozoa
 D Spermatogonia → Spermatozoa → Germinal epithelial cells (2)

Questions 1.5–1.7 refer to the diagram below.

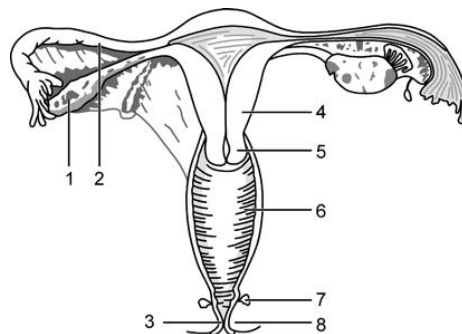

- 1.5 The vulva includes parts ...
- A 1 and 2
 - B 3 and 8
 - C 4 and 5
 - D 5 and 6
- (2)
- 1.6 Oogenesis occurs in part ...
- A 4
 - B 3
 - C 2
 - D 1
- (2)
- 1.7 The developing embryo attaches itself to part ...
- A 1
 - B 2
 - C 3
 - D 4
- (2)
- (14)

Question 2

Use the correct scientific terms when answering these questions.

- 2.1 The outermost of four extra embryonic membranes which contributes to the formation of the placenta.
- 2.2 The site of sperm manufacture in humans.
- 2.3 The endocrine gland that produces FSH.
- 2.4 Process of ovum production.
- 2.5 Prevention of pregnancy.
- 2.6 Fusion of a male and female gamete.
- 2.7 Three time periods of pregnancy.
- 2.8 The innermost lining of the uterus.
- 2.9 Site of testosterone production.
- 2.10 Hormone responsible for secondary sexual characteristics in females. (10)

Question 3

Match the items from COLUMN 2 with a description in COLUMN 1.

Column 1	Column 2
3.1 Changes into the corpus luteum	A Fallopian tube
3.2 Attachment of the foetus to the uterus	B Graafian follicle
3.3 Site of fertilisation in women	C vasectomy
3.4 Cells in the testes that nurture sperm cells	D vagina
3.5 Surgical procedure in men to prevent fertilisation of the ovum.	E Sertoli
3.6 Site where copulation occurs	F placenta
3.7 Organ associated with oogenesis	G ovary

(7)

Question 4

Study the diagrams below and answer the questions that follow.

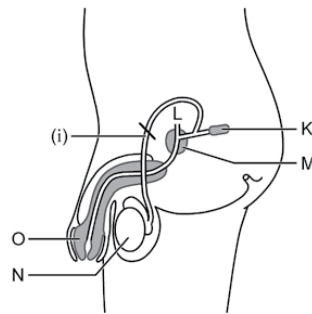
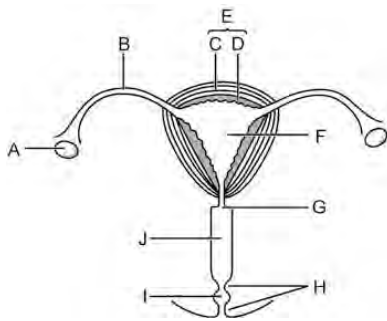

- 4.1 Select and write down the letter labelling the part involved in:
- | | | |
|--------------------------|------------------------------|----------------------|
| (i) ovulation | (ii) fertilisation | (iii) implantation |
| (iv) ejaculation | (v) urination | (vi) menstruation |
| (vii) birth contractions | (viii) containing the amnion | (ix) prostate cancer |
- (9)
- 4.2 Select and write down the letter labelling the part involved in the following methods of contraception:
- | | | |
|--------------------|--------------------|-----------------|
| (i) the coil | (ii) the dutch cap | (iii) the pill |
| (iv) sterilisation | (v) femidom | (vi) spermicide |
- (6)
- 4.3 Semen will contain secretions from which structures, if a vasectomy is performed at (i) in the diagram? (2)

Question 5

The basal body temperature is the temperature taken in the morning when factors such as exercise, eating, drinking or emotional disturbances have no influence. In woman the basal body temperature drops just before ovulation and then increases sharply a day later. During menstruation, the temperature drops again to normal. If the temperature stays high, pregnancy is presumed. Josephine and Patsy, two young healthy women, recorded their basal body temperature for 28 days from the first day of menstruation. The results are shown in the table below. Study the table and answer the questions that follow.

Basal body temperature of Josephine and Patsy for 28 days					
Menstruation cycle (days)	Body temperature (°C)		Menstruation cycle (days)	Body temperature (°C)	
	Josephine	Patsy		Josephine	Patsy
1	36,5	36,4	15	36,6	36,5
2	36,2	36,3	16	36,7	36,6
3	36,2	36,3	17	36,8	36,7
4	36,2	36,3	18	36,8	36,7
5	36,2	36,3	19	36,9	36,7
6	36,2	36,3	20	36,9	36,6
7	36,3	36,2	21	37,0	36,7
8	36,2	36,2	22	37,1	36,4
9	36,3	36,2	23	37,1	36,3
10	36,2	36,2	24	37,2	36,3
11	36,2	36,2	25	37,1	36,3
12	36,2	36,2	26	37,0	36,2
13	36,1	36,1	27	37,2	36,3
14	36,5	36,5	28	37,2	36,2

- 5.1 On which day of the menstrual cycles of the two woman did ovulation occur? (1)
- 5.2 What is the difference between the basal body temperatures of Josephine and Patsy on day 28 of their menstrual cycles? (1)
- 5.3 These measurements were made at the same time each day in the same room and while each woman was wearing the same type of dressing gown. Explain why these precautionary measures were necessary. (2)
- 5.4 By interpreting the data in the table:
- 5.4.1 Which of the two women is pregnant? Give a reason for your answer. (2)
- 5.4.2 Explain how basal body temperature could be used as a method of contraception. (2)
- 5.4.3 Explain ONE disadvantage of using the basal body temperature as a method of contraception. (2)

5.5 The graph below shows the levels of the hormones oestrogen and progesterone in the pregnant woman's blood. Answer the questions that follow.

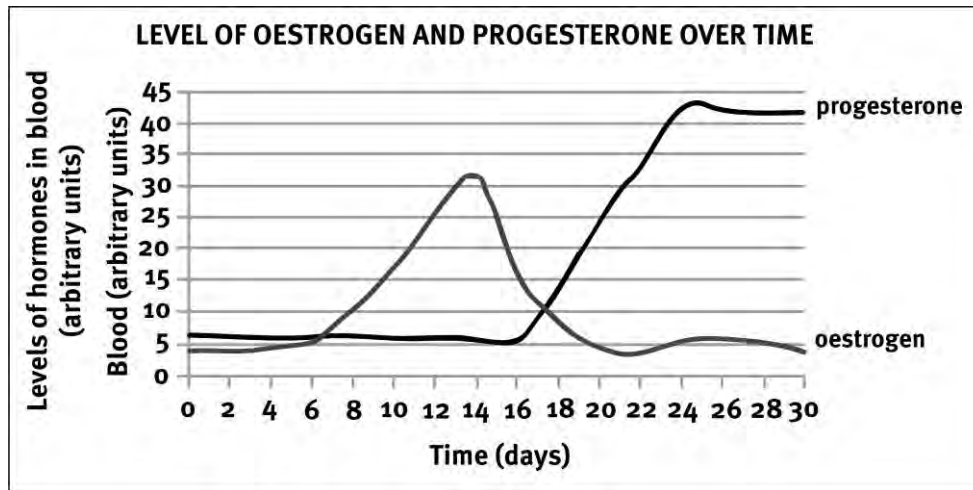

- 5.5.1 When are the levels of oestrogen and progesterone equal? (2)
- 5.5.2 What is the amount of oestrogen in the blood on day 14? (2)
- 5.5.3 What evidence from the graph shows that an ovum was fertilised? (1)

5.6 Study the diagram below of the developing foetus.

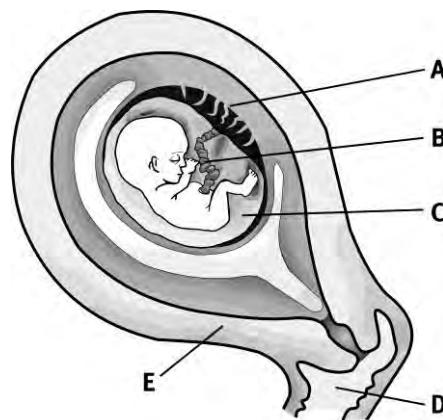

- 5.6.1 Label structures A,B and D. (3)
- 5.6.2 Give TWO functions of the fluid found in C. (2)
- 5.6.3 Name the process by which some of the fluid from C is withdrawn by doctors to test for abnormalities in the foetus. (1)
- 5.6.4 Describe the function of E during the birth process. (2)

TOTAL MARKS: 70

Answers to Questions

Question 1

- 1.1 A ✓✓ (2)
1.2 A ✓✓ (2)
1.3 B ✓✓ (2)
1.4 B ✓✓ (2)
1.5 B ✓✓ (2)
1.6 D ✓✓ (2)
1.7 D ✓✓ (2)

Question 2

- 2.1 chorion ✓
2.2 seminiferous tubules / testes ✓
2.3 hypothalamus / pituitary ✓
2.4 oogenesis ✓
2.5 contraception ✓
2.6 fertilisation ✓
2.7 trimesters ✓
2.8 endometrium ✓
2.9 interstitial cells / testes ✓
2.10 oestrogen ✓ (10)

Question 3

- 3.1 A ✓
3.2 F ✓
3.3 A ✓
3.4 E ✓
3.5 C ✓
3.6 D ✓
3.7 G ✓ (7)

Question 4

- | | | | | |
|-----|-------------|------------|-----------|-----|
| 4.1 | (i) A ✓ | (ii) B ✓ | (iii) D ✓ | |
| | (iv) O ✓ | (v) I/L ✓ | (vi) D ✓ | |
| | (vii) E ✓ | (viii) F ✓ | (ix) M ✓ | (9) |
| 4.2 | (i) F ✓ | (ii) G ✓ | (iii) A ✓ | |
| | (iv) N/B ✓ | (v) J ✓ | (vi) J ✓ | (6) |
| 4.3 | K ✓ and M ✓ | | | (2) |

Question 5

- 5.1 Day 14 ✓ (1)
- 5.2 1 °C ✓ (1)
- 5.3 For validity and reliability of measurements used for comparison ✓✓ (2)
- 5.4.1 Josephine ✓ Her basal body temperature remains high to the end of her cycle. ✓ (2)
- 5.4.2 A sharp increase in temperature indicates ovulation. ✓ Intercourse should not take place after that time. ✓ (2)
- 5.4.3 Basal body temperature can increase for other reasons ✓ and ovulation can occur before basal metabolism increases. ✓ (2)
- 5.5.1 On day 17 ✓✓ (2)
- 5.5.2 32,5 arbitrary units ✓✓ (2)
- 5.5.3 Increase in progesterone production. ✓✓ (1)
- 5.6.1 A – placenta ✓
B – umbilical cord ✓
D – vagina ✓ (3)
- 5.6.2 Shock absorber ✓ Prevents dehydration ✓ Allows for free movement ✓ (any 2) (2)
- 5.6.3 amniocentesis (1)
- 5.6.4 Contractions put pressure on the foetus to expel it from the body. ✓✓ (2)

TOTAL MARKS: 70

Overview

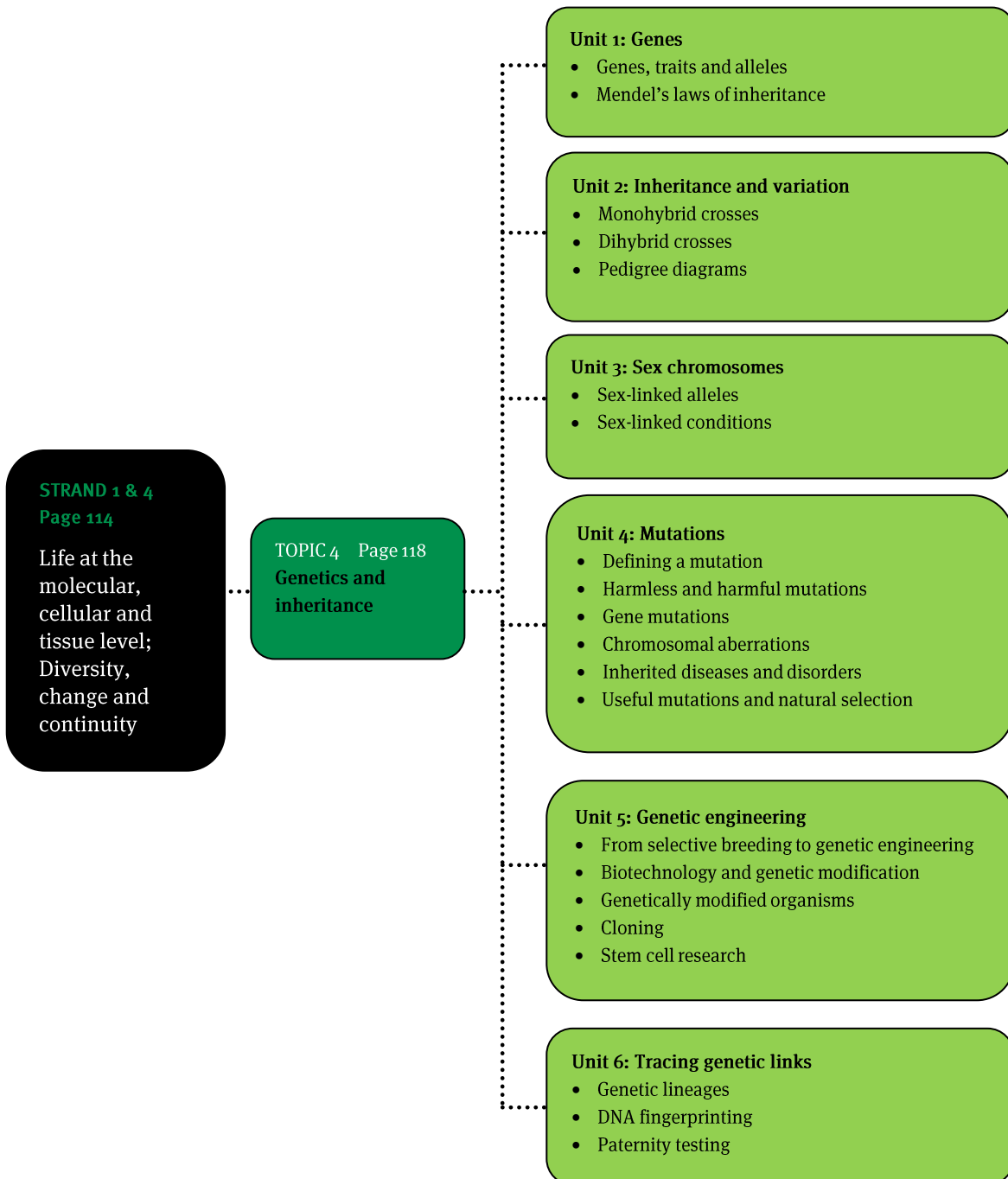

Units 1 to 6

1 Terminology

- **Genetics** – The science of heredity studies; attempts to explain similarities and differences in characteristics displayed in a population of organisms or individuals and between parents and offspring; investigates the nature of associated genomes.
- **Genome** – The complete variety of hereditary DNA content of a body cell of an organism, or a population of organisms of the same species.
- **Genotype** – The unique genetic content of the genome of an individual organism or a population of organisms of the same species.
- **Chromosomes** – Dehydrated and condensed strands of DNA and associated proteins in the nucleus of eukaryotic cells. The chromosomes carry the genes that function in the transmission of hereditary information. Chromosomes may also be a circular strand of DNA in bacteria that contain its hereditary information. Maternal and paternal chromosomes are homologous pairs.
- **Autosomes** – The paired somatic (body) chromosomes that are the same for all members of a species – for both genders. They are not gender (sex) chromosomes. In humans, there are 22 pairs of autosomes.
- **Sex chromosomes** – Used in the determination of gender. In the XY sex determination system, females have two of the same kind of sex chromosomes (XX), while males have two separately distinct sex chromosomes (XY).
- **Phenotype** – The visible characteristic features, which the genotype produces as visible traits and forms in an organism or a population of organisms of the same species.
- **Traits** – Notable, visible characteristics of an organism.
- **Forms** – The descriptive features of characteristic traits. For example, hair colour is a trait and the colours brown, red, black and blond are the forms.
- **Genes** – Sections of DNA that code for the manufacture of protein(s) that result in a particular phenotype (trait and form).
- **Locus** – The specific location of each gene in the chromosome.
- **Allele** – A complementary set of alternative gene forms for a certain trait (like eye colour) found on both homologous chromosomes. For example, Bb may indicate an allele for fur colour, which contains a black (B) and a brown (b) gene.
- **Dominant** – The phenotype of a gene in the offspring that ‘hides’ the phenotype of the other gene in heterozygous diploid organisms.
- **Recessive** – The gene that has its phenotype masked by a dominant gene phenotype in the offspring of heterozygous diploid organisms.
- **Cross (genetic)** – A selective breeding/mating between organisms with particular traits.

- **Selective breeding** – The intentional mating of animals or plants in an attempt to produce offspring with desirable characteristics, or to remove an undesirable trait. It is also known as artificial selection, and produces hybrids and varieties.
- **Inbreeding** – The fertilisation of gametes between closely related individuals, which tends to increase the number of individuals that are homozygous (see below) for a trait, and to increase the occurrence of recessive traits in a population.
- **Outbreeding** – Breeding distantly related individuals from different populations.
- **Homozygous** – The genes for a specific trait and its form, making up the genome of an organism, are identical. Such an organism has identical genes at the corresponding loci of homologous chromosomes. The associated genetic trait and its form are pure-bred.
- **Heterozygous** – The genes for a specific trait and its form making up the genome of an organism are different. The associated genetic trait is mixed.
- **Haploid** – Organisms, tissues or cells that have one set of chromosomes.
- **Diploid** – Organisms, cells or tissues that have two sets of chromosomes.
- **Polyploidy** – More than two homologous sets of chromosomes in a cell. It occurs mostly in plants, some animals, and occasionally in humans. Whole sets of chromosomes are involved. Polyploid types are named according to the number of chromosome sets in the nucleus. Polyploidy occurs in humans in the form of triploidy (69) and tetraploidy (92).
- **Aneuploidy** – Found in humans when an extra chromosome is found, for example 47 or 45. Refer to Down syndrome, Klinefelter syndrome and Turner's syndrome.
- **Multiple alleles** – Three or more alternative versions of a gene for the same locus on the same chromosome pair. Any two of these alternatives can be paired with each other in a diploid organism. An example is the pairing of any two of the three genes that determine the different blood types (blood groups) in humans.
- **Polygenic trait** – A trait affected by more than one gene locus that involves active and inactive alleles. Some trait alleles have genes at three or more different locations on the same or different chromosomes. This is known as polygenic inheritance. Many traits, such as height, shape, weight, skin colour and metabolic rate, are governed by the collective effects of many genes, each adding its effect to a single phenotype. It involves active and inactive alleles.
- **Mutation** – A change in the DNA structure of a chromosome.
- **Pedigree diagram** – a diagram of family relationships.

2 Mendel's laws

- **Law of dominance** – if a dominant gene is present in a pair of alleles, then the recessive trait or characteristic is hidden / masked (does not 'show' itself).
- **Law of segregation** – alleles separate and are randomly divided between different gametes (sperm, egg). This gives many possible combinations of the same alleles in the following generations.
- **Law of independent assortment** – The different characteristics of pea plants are passed on to the off spring independently of one another.

3 The monohybrid cross

- A monohybrid cross is a selective breeding cross that involves a single allele of genes that codes for two different traits of the same body form or part. Such a hybrid originates from parents that are different only with respect to a single gene pair.
- The genotypic ratio in the second inbred generation is 1:2:1.

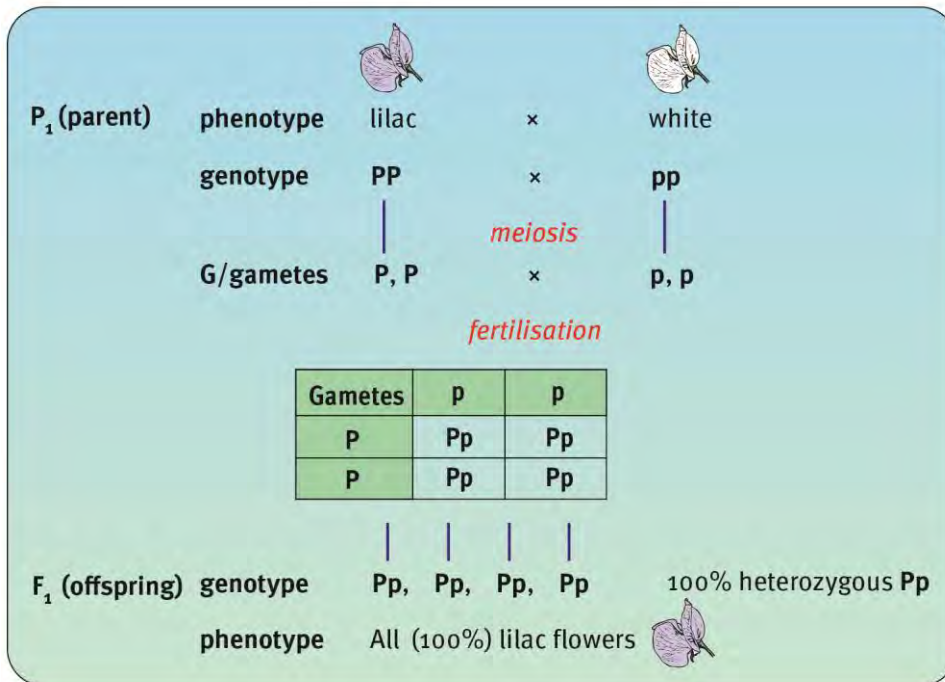

Figure 20 Monohybrid cross

4 Incomplete or partial dominance

- Not all alleles are either dominant or recessive.
- In incomplete dominance, (also called partial dominance) neither of the characteristics is dominant over the other, resulting in the off spring showing a 'new', mixed characteristic.
- Both genes are written with capital letters for the allele.

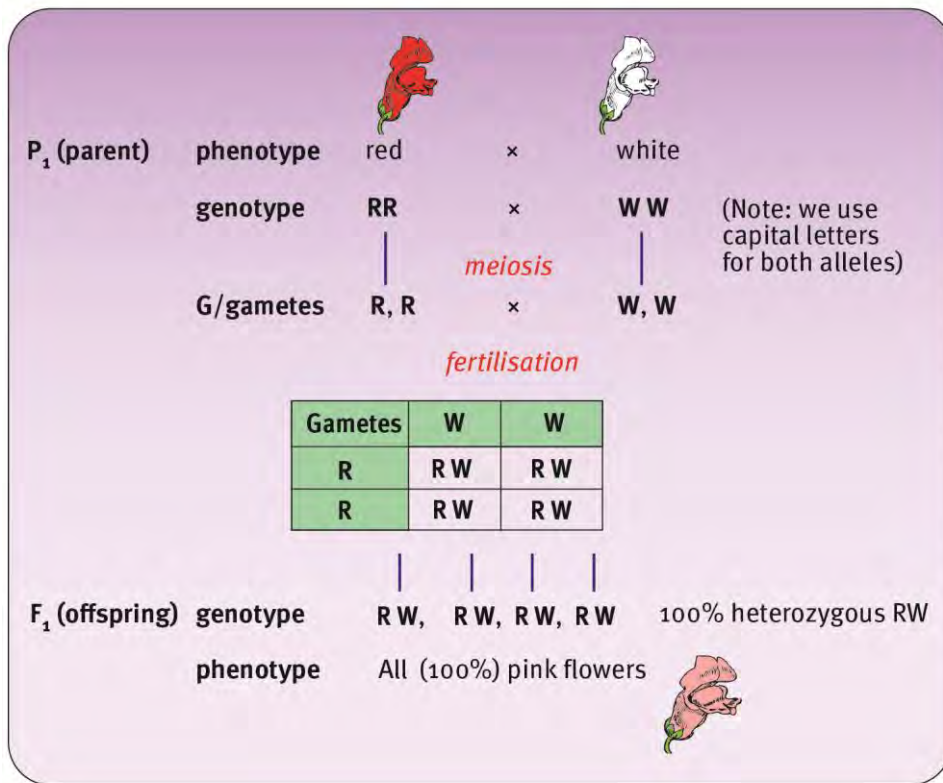

Figure 21 Incomplete dominance

5 Codominance

- Co-dominant' alleles are equally dominant. They are both present in the phenotype when they are combined.
- Blood groups are co-dominant: Dominant genes are the blood antigens A and B (I^A and I^B); the recessive gene is for the expression of neither antigen (i).

Table 8 Blood group allele combinations	
Blood type	Gene combinations
TYPE A	I ^A I ^A OR I ^A i
TYPE B	I ^B I ^B OR I ^B i
TYPE AB	I ^A I ^B
TYPE O	ii

6 Dihybrid crosses

- A dihybrid cross involves inheritance patterns for organisms that differ in two traits on one chromosome.
- The genotypic ratio for the second inbred generation is 9:3:3:1.

7 Sex-linked genes

- Genes carried on the sex chromosomes are sex-linked genes.
- Some sex-linked traits are genes for conditions that include serious disorders.
- Examples are the genes that cause muscular dystrophy, haemophilia and colour blindness.

8 Genetic counselling

Genetic counselling is involved in analysing or studying:

- a personal or family history of miscarriages or stillbirths
- a child or a family history of a genetic condition, chromosome abnormality.

9 Mutations

- Mutations can occur on a macroscopic level as chromosomal aberrations.
- Mutations can also be gene mutations, preventing the synthesis of the correct protein.
- They may also occur outside of the gene coding areas, such as in regulatory regions of DNA. They may also be point mutations, the result of a single base pair change in the DNA sequence of a gene.
- Gene mutations may be harmful or harmless.
- Natural selection makes use of mutations: advantageous mutations are passed on and assist in the adaptation of organisms to a changing environment.

10 Genetic engineering

- Selective breeding is the process of breeding plants and animals for particular traits.
- Genetic engineering directly manipulates the genes of a plant or animal using technology.
- Combining genes from different organisms is known as recombinant DNA technology. The resulting organism is said to be 'genetically modified'.
- Cloning and stem cell research are also associated with genetic engineering.

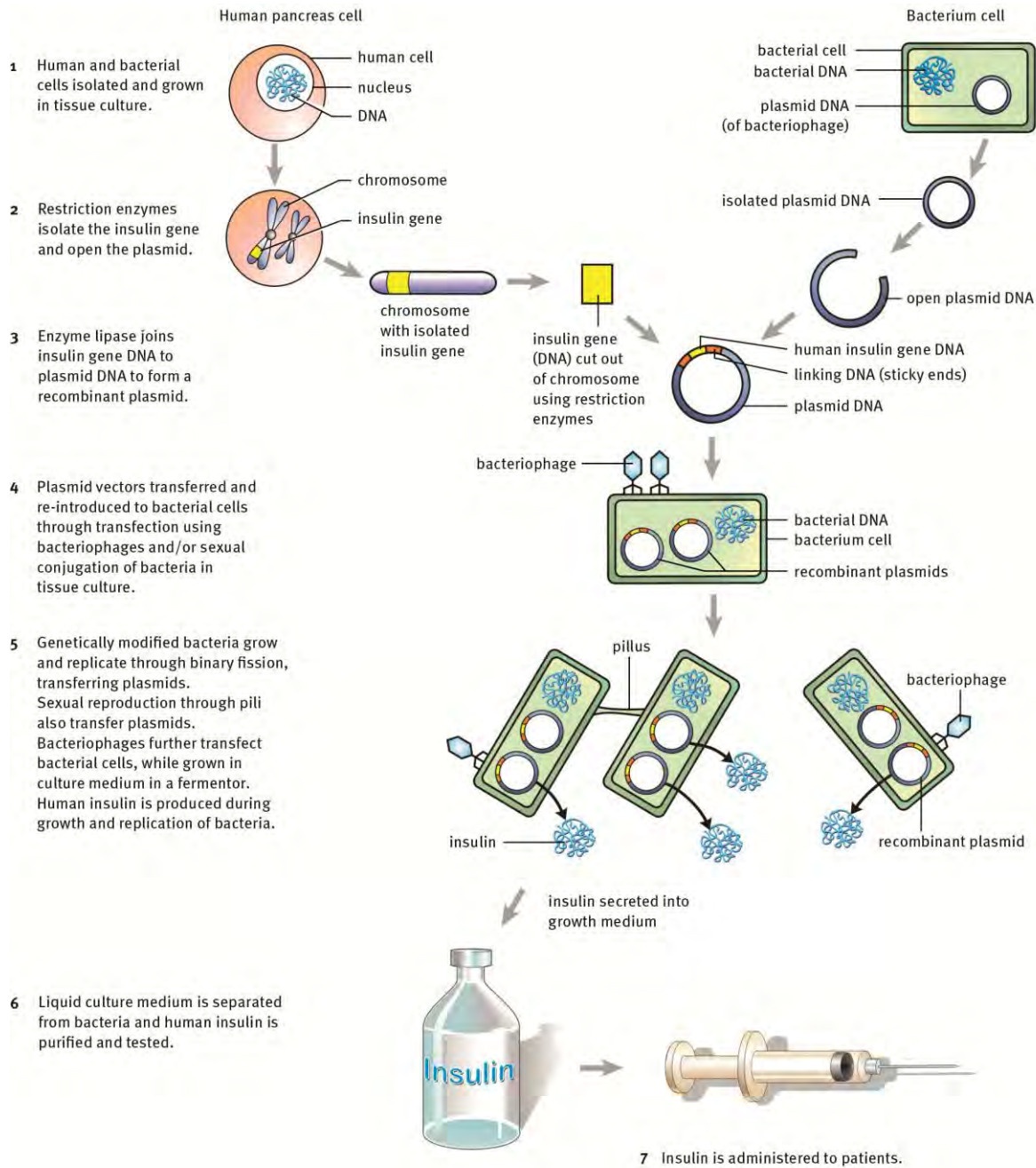

Figure 22 Manufacture of insulin

11 DNA fingerprinting

- Uses repetitive sequences in DNA that are highly variable, called variable number tandem repeats (VNTRs), including short tandem repeats (STRs).
- VNTR variants are very similar between closely related humans, but unrelated people are very unlikely to have the same VNTRs.
- STRs give a very high probability of accurate results and are used to identify people from blood, skin tissue and hair samples, as well as, genetic inherited disorders, parentage, or inheritance.

Questions

Question 1

Various answers are provided to each question. Choose the correct answer. Only write the letter of the answer you select next to the question number.

- 1.1 The two genes that control the same characteristic are termed ...
A recessive
B alleles
C dominant
D heterozygous (2)
- 1.2 A pure-bred red-flowering plant was crossed with a pure-bred white flowering plant, and all the F₁ generation plants had red flowers. Which one of the following is applicable?
A The white gene is recessive to the red gene.
B The red gene is recessive to the white gene.
C The F₁ generation plants were all homozygous for the red gene.
D The F₁ generation plants were all homozygous for the white gene. (2)
- 1.3 If a house mouse has 40 chromosomes in each body cell, how many autosomes are present in each gamete?
A 1
B 19
C 20
D 39 (2)
- 1.4 A plant cell with 11 chromosomes is ...
A a zygote
B homozygous
C diploid
D haploid (2)
- 1.5 A man has a recessive gene on all his X chromosomes. What is the probability of this gene being present in his first daughter?
A 25%
B 50%
C 75%

- D 100% (2)
- 1.6 Attempts to treat cystic fibrosis using gene therapy have used viruses as vectors. The viruses are introduced into the lungs using aerosols. Viruses are useful as vectors because ...
- A They kill the cells that are causing cystic fibroses.
- B They have a protein coat and cannot be destroyed by antibiotics.
- C They have RNA not DNA and therefore cannot alter the cells' DNA.
- D They can insert their piece of DNA into the cells' DNA thereby correcting the faulty sequence. (2)
- (12)

Question 2

Use the correct scientific terms when answering these questions.

- 2.1 Having two identical genes for one characteristic
- 2.2 An individual having two genes that determine a characteristic in the same way
- 2.3 A genetic cross involving genes that cannot be regarded as dominant or recessive
- 2.4 Cell division that leads to the formation of gametes
- 2.5 The short DNA fragments commonly used to transfer genes in biotechnology (5)

Question 3

Indicate whether the following statements are TRUE or FALSE. Write either 'True' or 'False' next to the question number. If the statement is FALSE, write down the correct statement.

- 3.1 The chromosome pair 23 in a human diploid cell is known as the autosome.
- 3.2 Chiasmata formation occurs in meiosis I.
- 3.3 Paternity tests determine the genetic relationships between a father and his children.
- 3.4 A phenotype ratio of 1:2:1 is found in a cross of a completely dominant trait. (4)

Question 4

Learners conducted a survey to determine knowledge about genetically modified (GM) foods. They used two questions in their investigation:

- Do you know what GM food is?
- Are you aware of any dangers in using GM foods?

- 4.1 Formulate an hypothesis for this investigation. (2)
- 4.2 State an independent variable to this investigation. (2)

Question 5

Read the case study below and answer the questions that follow.

Case study: Haemophilia

Haemophilia is an hereditary blood disease characterized by the inability of blood to clot, or coagulate, leading to excessive bleeding, even from minor injuries. It is caused by an insufficiency or absence of certain blood proteins, called factors, which participate in blood clotting. Severity varies greatly. The bleeding may occur as excessive bruising or persistent bleeding after a simple cut.

About 80 % of all cases have an identifiable family history of the disease but it is also attributable to a spontaneous mutation of genes. Inheritance is controlled by a recessive gender-linked factor carried by the mother on the X chromosome. One in two boys born to a normal male and a carrier female will be haemophiliac, and the same chance exists that each girl of this union will be a carrier. Of the children of a haemophiliac male and a normal female, all the girls will be carriers and all the boys will be normal. Males cannot transmit the disability, and female carriers are free of the disease. A famous case of the transmission of haemophilia involved Queen Victoria of Great Britain, whose daughters carried the disease to the Spanish and Russian royal houses.

Prevention of trauma is important for a patient, and when bleeding occurs, replacement therapy may be necessary. Freshly-frozen blood plasma can be used to treat mild forms.

- 5.1 What is haemophilia? (2)
- 5.2 What causes the disorder? (2)
- 5.3 Why can this disorder be considered as a gender-linked disorder? (2)
- 5.4 Suggest two treatment methods for this disease. (2)
- 5.5 A large number of haemophiliacs have already been exposed to the AIDS virus. Explain why this has happened. (3)

Question 6

The following histograms represent the percentage of various genotypes that occur in the F₁ generation of monohybrid crosses. For each histogram, work out the genotypes of the parents (P₁). (12)

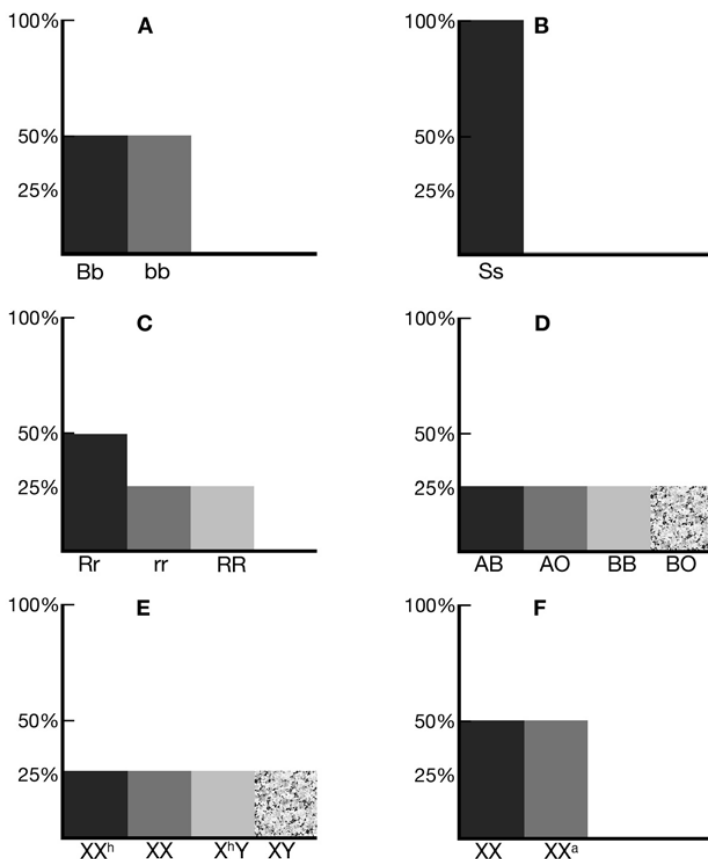

Question 7

A buff butterfly, true-breeding for brown wing colour, is crossed with a butterfly that is not true-breeding for pink wing colour. All the F₁ butterflies had brown wings.

- 7.1 Is brown wing colour dominant or recessive? Give a reason. (2)
- 7.2 Write out the genotypes for the brown-winged and pink-winged parents, and give one reason for each answer. (6)
- 7.3 Write out the genotype for the brown-winged offspring. (2)
- 7.4 If the F₁ butterflies were allowed to interbreed, what would the phenotype and genotype ratio between brown-winged and pink-winged butterflies be in the F₂ generation? (2)

Question 8

The ability of a person to form pigment in the skin, hair and eyes depends on the presence of a particular gene (A), whereas the lack of this ability, known as albinism, is caused by another gene (a) of the same allele. The effects of (A) are dominant, and those of (a) are recessive. So heterozygous individuals (Aa), as well as those that are homozygous for the pigment-producing allele (AA), have normal pigmentation. Use the family trees below to answer the questions following.

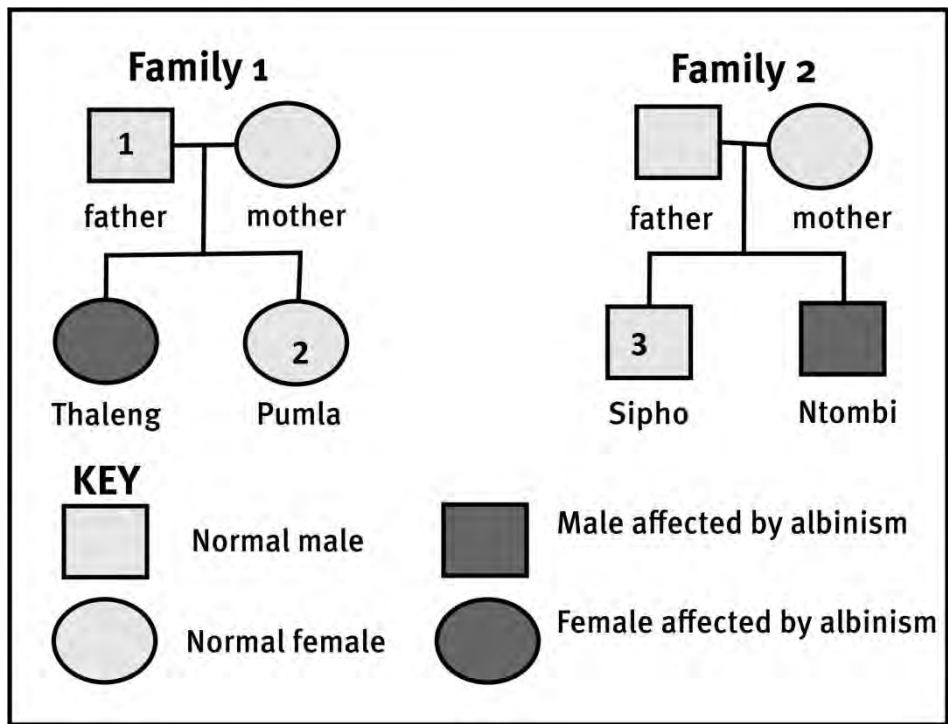

- 8.1 State the genotype of numbers 1 and 3. (2)
- 8.2 From the diagram:
- 8.2.1 Work out Thaleng's genotype. (1)
- 8.2.2 State whether Thaleng suffers from albinism. (1)
- 8.3 Thaleng and Sipho intend to get married. Show, in family tree form using the key, all the possible genotypes for a male child born from such a marriage. (4)
- 8.4 In your opinion, should Thaleng and Sipho reconsider having children? Explain your answer. (2)

TOTAL MARKS: 70

Answers to Questions

Question 1

- 1.1 B ✓✓
- 1.2 A ✓✓
- 1.3 D ✓✓
- 1.4 D ✓✓
- 1.5 D ✓✓
- 1.6 D ✓✓

(12)

Question 2

- 2.1 Homozygous ✓
- 2.2 Purebred / homozygous ✓
- 2.3 Codominant ✓
- 2.4 meiosis ✓
- 2.5 plasmids ✓

(5)

Question 3

- 3.1 False ✓ The chromosome pair 23 in a human diploid cell is known as the sex chromosome. ✓
- 3.2 True ✓✓
- 3.3 True ✓✓
- 3.4 True ✓✓

(4)

Question 4

- 4.1 People know what GM food is. ✓✓
OR
People do not know what GM food is. ✓✓ (2)
- 4.2 Age, sex or socio-economic status of the people interviewed. ✓✓ (2)

Question 5

- 6.1 Haemophilia is a sex-linked genetic disorder ✓ associated with no production of blood clotting factor. ✓ (2)
- 6.2 No blood clotting factor is produced. ✓✓ (2)
- 6.3 It is located on the X sex chromosome. ✓✓ (2)
- 6.4 Prevention of trauma ✓ and plasma replacement therapy. ✓ (2)
- 6.5 From blood replacement ✓ that has not been screened properly. ✓ The virus has been transferred during transfusion. ✓ (3)

Question 6

- A – BB ✓ x bb ✓
- B – SS ✓ x ss ✓
- C – Rr ✓ x Rr ✓
- D – I^AI^B ✓ x I^Bi ✓
- E – XX^h ✓ x XY ✓
- F – XX ✓ x XX^a ✓ (12)

Question 7

- 7.1 Brown wing colour is dominant. ✓ All offspring have brown wings. ✓ (2)
- 7.2 True-breeding brown winged parent is homozygous. ✓ Both genes are dominant. ✓ BB ✓
Not true-breeding pink winged parent is heterozygous. ✓ Both genes are different. ✓ Bb ✓ (6)
- 7.3 50% BB ✓ 50% Bb ✓ (2)
- 7.4 Phenotype F₂: brown: pink winged butterflies = 4:0 ✓
Genotype F₂: BB:Bb = 1:1 ✓ (2)

Question 8

- 8.1 1 – Aa ✓ 3 – Aa/AA ✓ (2)
- 8.2.1 Thaleng = aa ✓ (1)
- 8.2.2 Thaleng is an albino ✓ as she has both recessive genes in her genome. (1)
- 8.3 Thaleng – aa; Sipho – Aa/AA.
Children's genotypes are: Aa ✓ and aa ✓ OR all Aa ✓✓ (4)

- 8.4 Yes, they should reconsider. ✓ Consider genetic counselling as 50% possibility of albino children. ✓ (2)

TOTAL MARKS: 70

Overview

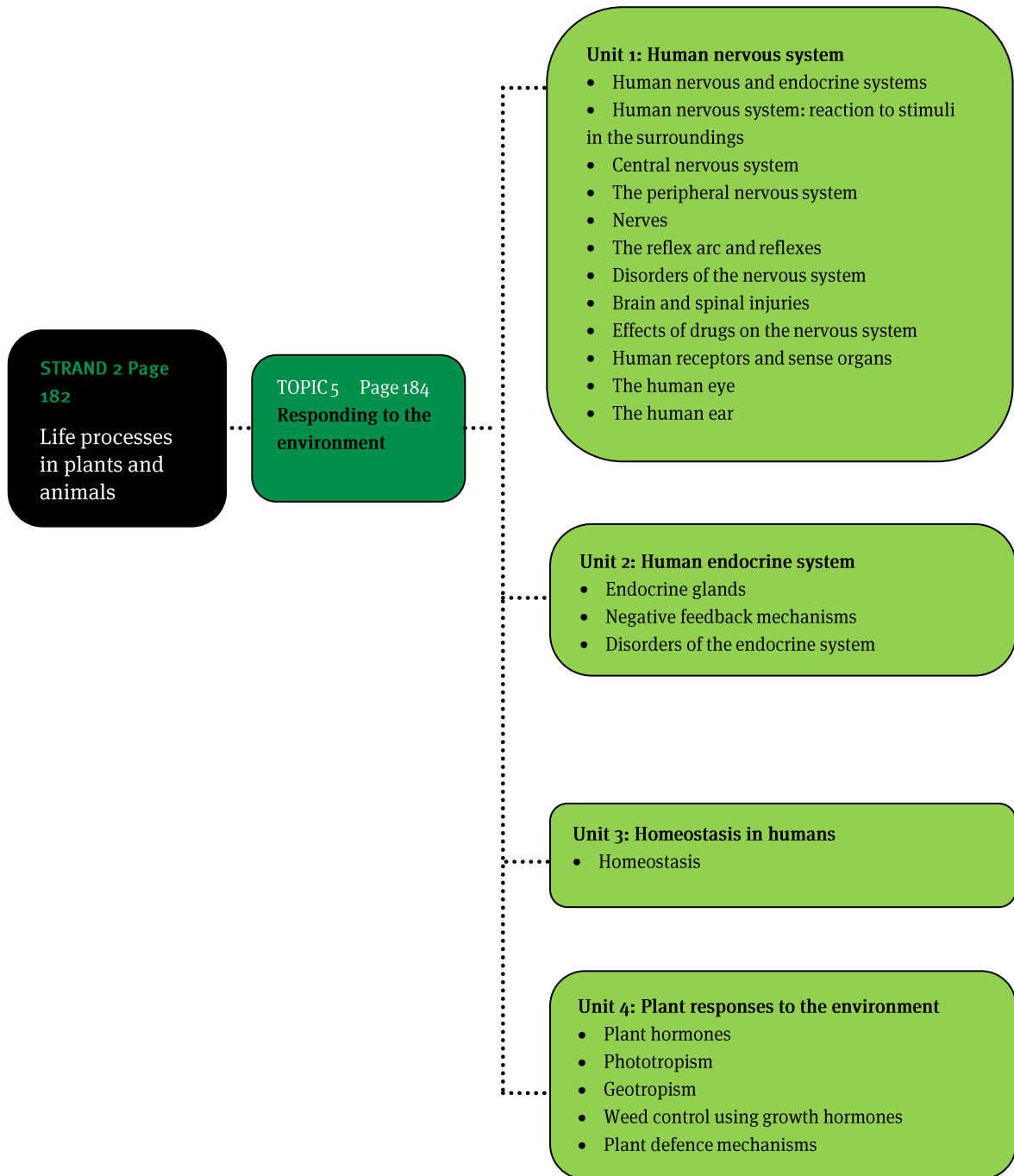

Units 1 to 4

1 The human nervous system

- The nervous system performs five main functions:
 1. It uses the senses to gather information.
 2. It transmits information to processing areas.
 3. It processes information.
 4. It formulates a response to stimuli.
 5. It sends information back through the network to effector organs (muscles, glands and other parts of the body) to execute the response.
- The human nervous system is made of three interacting nerve sub-systems: the central, peripheral and the autonomic nervous systems.

2 The central nervous system

- The brain and the spinal cord together form the central nervous system (CNS).
- The whole CNS is surrounded by a system of membranes called the meninges, which protect it:
 - dura mater (outer membrane) – tough fibrous membrane lining the skull
 - arachnoid (middle membrane) – thin and vascular
 - pia mater (inner membrane) – delicate membrane lining the folds of the brain.
- Cerebrospinal fluid is found in the sub-arachnoid cavity between the arachnoid and pia mater; it cushions the brain against shock, helps to maintain even pressure in and around the brain and spinal cord, and keeps the nervous tissue moist.

Table 9 Regions of the brain and their functions

Region of the brain	Function
Cerebrum	Voluntary actions; receives and interprets all sensations (sight, hearing, smell, taste and touch); memory, judgement and reasoning
Hypothalamus	Control of: body temperature, blood pressure, sleep, appetite, thirst, emotions
Cerebellum	Co-ordination of voluntary movements (walking, running); maintaining muscle tone; balance, posture and equilibrium
Medulla oblongata	Maintaining involuntary reflex functions like breathing, regulating heart beat, dilating and constricting blood vessels, salivation and swallowing; conducts impulses from the spinal cord to higher parts of the brain Nerves cross over – right hand side of the brain controls the left hand side of the body and vice versa
Thalamus	Relay centre for electrical impulses travelling to and from cerebral cortex

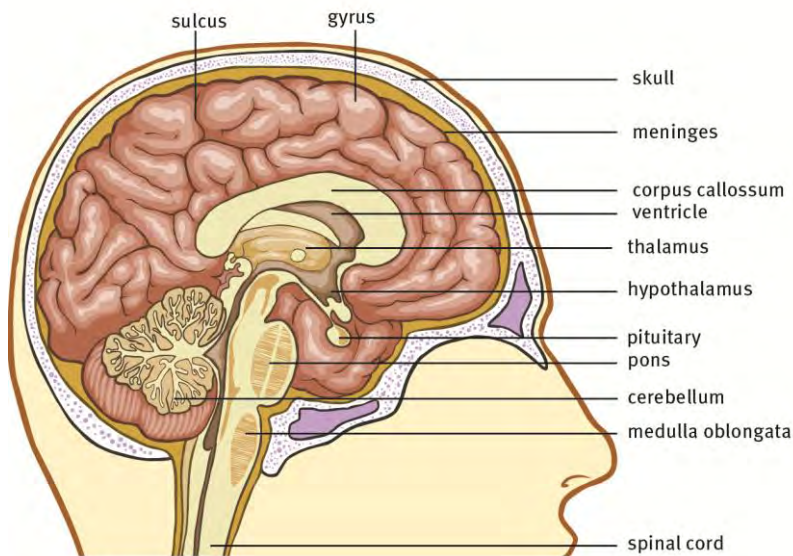

Figure 23 Internal structure of the human brain

2.1 The cerebrum

Table 10 Regions of the cerebrum and their functions

Region of the cerebrum	Function
Frontal lobe (in front of fissure of Rolando)	Motor area; controls voluntary movements, like speech
Parietal lobe (anterior to fissure of Rolando)	Centre for interpreting sensations from the skin
Occipital lobe (behind each hemisphere)	Centre for sight
Temporal lobe (below fissure of Sylvius)	Centre for hearing, tasting and smelling
Association areas	Reasoning, intelligence, memory, judgement

2.2 The cerebellum

- The cerebellum is made of two hemispheres joined by a narrow strip called the vermis.
- The outer region (cortex) is made up of grey matter and the inner medulla is made of white matter and is a tree-like structure known as the arbor vitae (tree of life).
- Damage to this part of the brain causes lack of muscle co-ordination, called ataxia.

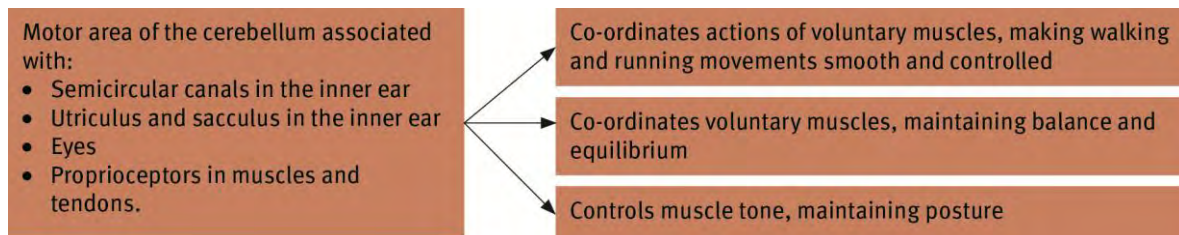

Figure 24 Functions of the cerebellum

2.3 The medulla oblongata

This is the lower part of the brain stem, and is a continuation of the spinal cord.

Table 11 Reflexes controlled by the medulla oblongata

Vital reflexes	Non-vital reflexes
Respiratory centre – breathing rate and depth	Salivation
Vasomotor centre – controls blood pressure and body temperature	Coughing
Cardio-motor centre – rate of the heart beat	Blinking
Visceral activities such as peristalsis, glandular secretions and swallowing	Hiccoughing
	Sneezing

2.4 The spinal cord

- The spinal cord is inside the vertebral canal, and is an extension of the brain.
- It is covered in the triple layer of meninges, which continue from the brain.
- From each side of the cord 31 pairs of spinal nerves arise from ventral and dorsal roots.
- The central canal (with cerebrospinal fluid) is in the centre of the cord and is continuous with the ventricles of the brain.
- The white matter is external and the grey matter internal in an H-shape. Spinal nerves enter and leave the spinal cord between the vertebrae.
- The vertebrae protect the spinal cord.

3 The reflex arc and reflexes

A reflex action is caused by a nerve signal or stimulus following a reflex arc.

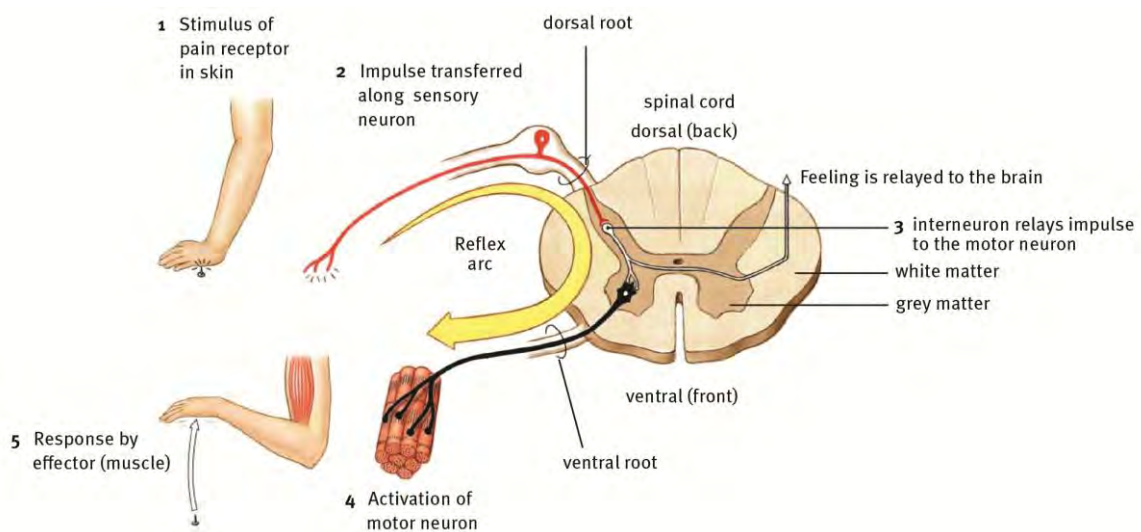

Figure 25 Reflex arc

4 Synapses

- A synapse allows a signal to pass from one neuron to another.
- It is a tiny gap, often between the end of an axon of one neuron and the dendrite of another.

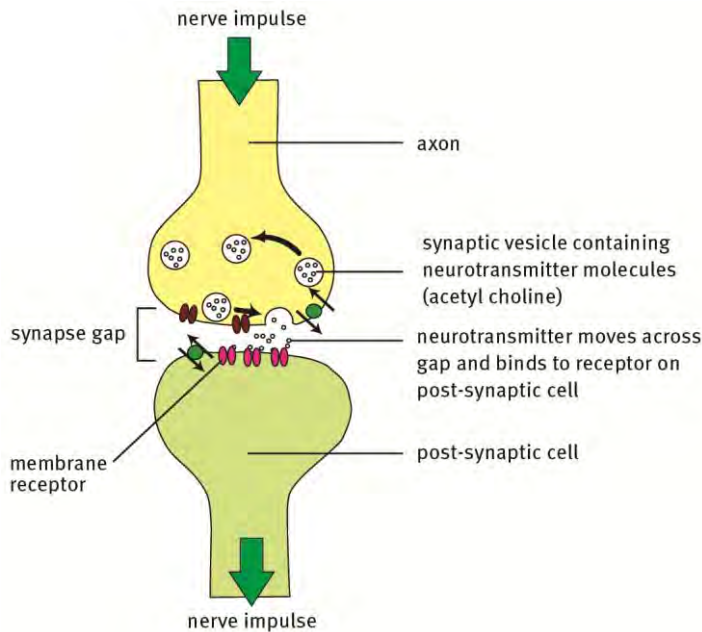

Figure 26 Structure and function of a synapse

5 Nerves

- Sensory neurons (afferent) – receive information and send impulses to the spinal cord and brain.
- Motor neurons (efferent) – conduct impulses from the spinal cord and brain to muscles or glands.
- Interneurons (connector neurons) – relay impulses from sensory neurons to motor neurons.

Table 12 Comparison of sensory and motor neurons

Sensory neurons	Motor neurons
Receive information, conduct impulses from muscles or glands throughout body to spinal cord and brain	Receive information, conduct impulses from spinal cord and brain to muscles or glands throughout body
Afferent neurons	Efferent neurons
Cell body has only one or two outgrowths – a dendrite and an axon	Cell body has many outgrowths – dendrites and an axon
Are monopolar and bipolar neurons	Are multipolar neurons

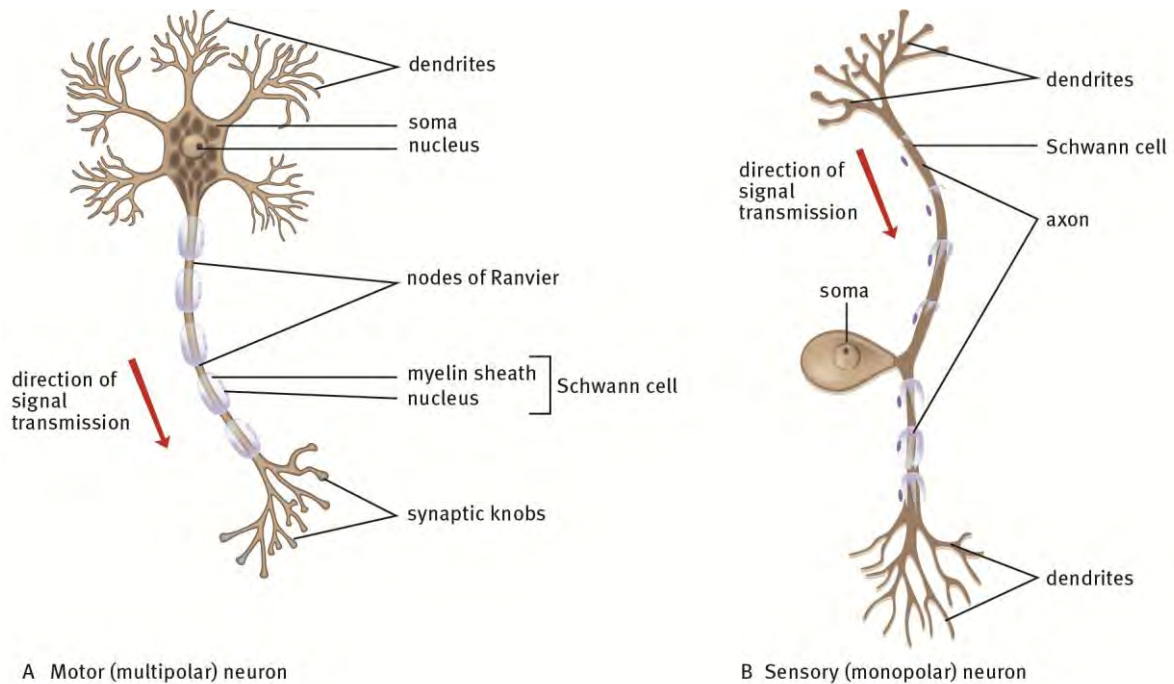

Figure 27 Structure of motor and sensory neurons

6 Disorders of the nervous system

- Alzheimer’s disease** – Alzheimer’s disease is caused by neuronal communication failure in the brain, due to decreased acetylcholine activity. It causes severe memory loss – patients may not recognise people they used to know. It is costly to treat and manage Alzheimer’s disease, and similar disorders, because there is no cure. Drugs that help produce acetylcholine have been tested but have led to severe side-effects.
- Multiple sclerosis** – Multiple sclerosis is a progressive, degenerative disorder of the CNS; damage done to the axon-coating myelin of nerve cells in communication pathways. MS is caused by an individual’s immune system attacking the nervous system - an auto-immune disease. Scattered patches of demyelination in the pathways make it impossible for messages to move over these hard areas. Stem cell research and biologically engineered production of interferons slow down the progress of the disease.

7 Effects of drugs on the nervous system

Table 13 Main effects of drugs on the CNS		
Type of drug	Effects on the CNS	Examples
Depressant drugs	Act on the neurotransmitter GABA (gamma aminobutyric acid). GABA is an inhibitory neurotransmitter that makes neurons less likely to activate.	Alcohol, benzodiazepines, barbiturates
Stimulant	Act on the neurotransmitter dopamine by increasing the	Amphetamines, cocaine,

drugs	amount of dopamine released into the synapse and preventing it from being removed from the synapse.	ecstasy, tik
Opioid drugs	Opioid drugs bind to special endorphin receptors in the brain that have to do with pain. When these receptors are occupied and activated, the perception of pain lessens.	Cocaine, heroin
Cannabinoids	Act on the neurotransmitters serotonin, dopamine and acetylcholine. It also binds to a receptor for a recently discovered neurotransmitter known as anandamide.	Dagga
Hallucinogens	Antagonises serotonin by blocking its release.	LSD

8 Human receptors

The sensory receptors are:

- photoreceptors – respond to light: rods and cones in the retina of the eye
- chemoreceptors – respond to chemicals; olfactory cells (in the nasal cavity) and taste buds (on the tongue)
- thermoreceptors – respond to temperature: Ruffini and Krause corpuscles
- mechanoreceptors – respond to mechanical stimuli: Pacinian and Meissner’s corpuscles, maculae in the ear
- proprioceptors – located in positions sensitive to position, tension and movement: muscles, tendons, maculae and cristae in the vestibular apparatus.

9 The human eye

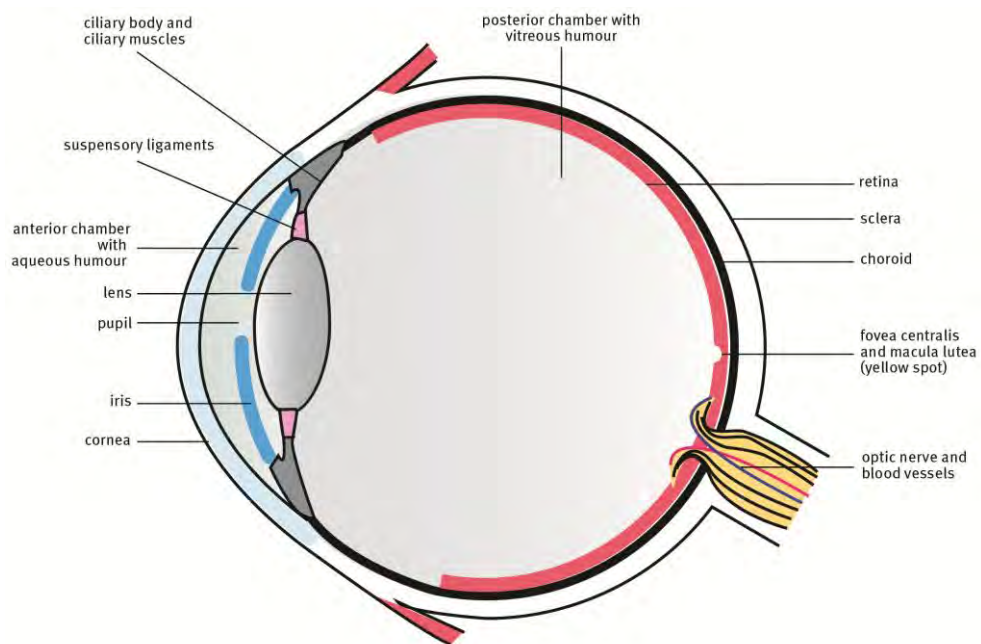

Figure 28 Internal structure of the eye

9.1 Accommodation

Table 14 Accommodation in the mammalian eye

Nearby objects (closer than 6 m)	Distant objects (further than 6 m)
<ol style="list-style-type: none"> 1 Ciliary muscles contract. 2 Sclera pulled forward. 3 Suspensory ligaments relax/slacken. 4 Tension on lens capsule decreases. 5 Lens becomes thicker (more convex). 6 Refractive power of lens increases. 7 Light rays bend inwards more. 8 Clear image of near object formed on retina. 	<ol style="list-style-type: none"> 1 Ciliary muscles relax. 2 Sclera returns to normal position. 3 Suspensory ligaments contract/tighten. 4 Tension on lens capsule increases. 5 Lens becomes thinner (less convex). 6 Refractive power of lens decreases. 7 Light rays bend inwards less. 8 Clear image of far object formed on retina.

9.2 Pupil reflex

Table 15 Pupillary mechanism for reflex to light intensities

High light intensity	Low light intensity
<ol style="list-style-type: none"> 1 Circular muscles of iris contract. 2 Radial muscles of iris relax. 3 Pupil constricts/decreases in diameter/gets smaller. 4 Less light enters the eye. 	<ol style="list-style-type: none"> 1 Circular muscles of the iris relax. 2 Radial muscles of the iris contract. 3 Pupil dilates/increases in diameter/gets larger. 4 More light enters the eye.

9.3 Short-sightedness and long-sightedness

Table 16 Comparison of short-sightedness and long-sightedness

Short sightedness (myopia)	Long-sightedness (hypermetropia)
<ul style="list-style-type: none"> • Eyeball is elongated (too long) • Cannot see distant objects clearly • Lens bends light rays too much • Light rays focus in front of the retina • Corrected with concave (negative) lens 	<ul style="list-style-type: none"> • Eyeball is flattened (too short) • Cannot see nearby objects clearly • Lens does not bend light rays enough • Light rays focus behind the retina • Corrected by convex (positive) lens

10 The human ear

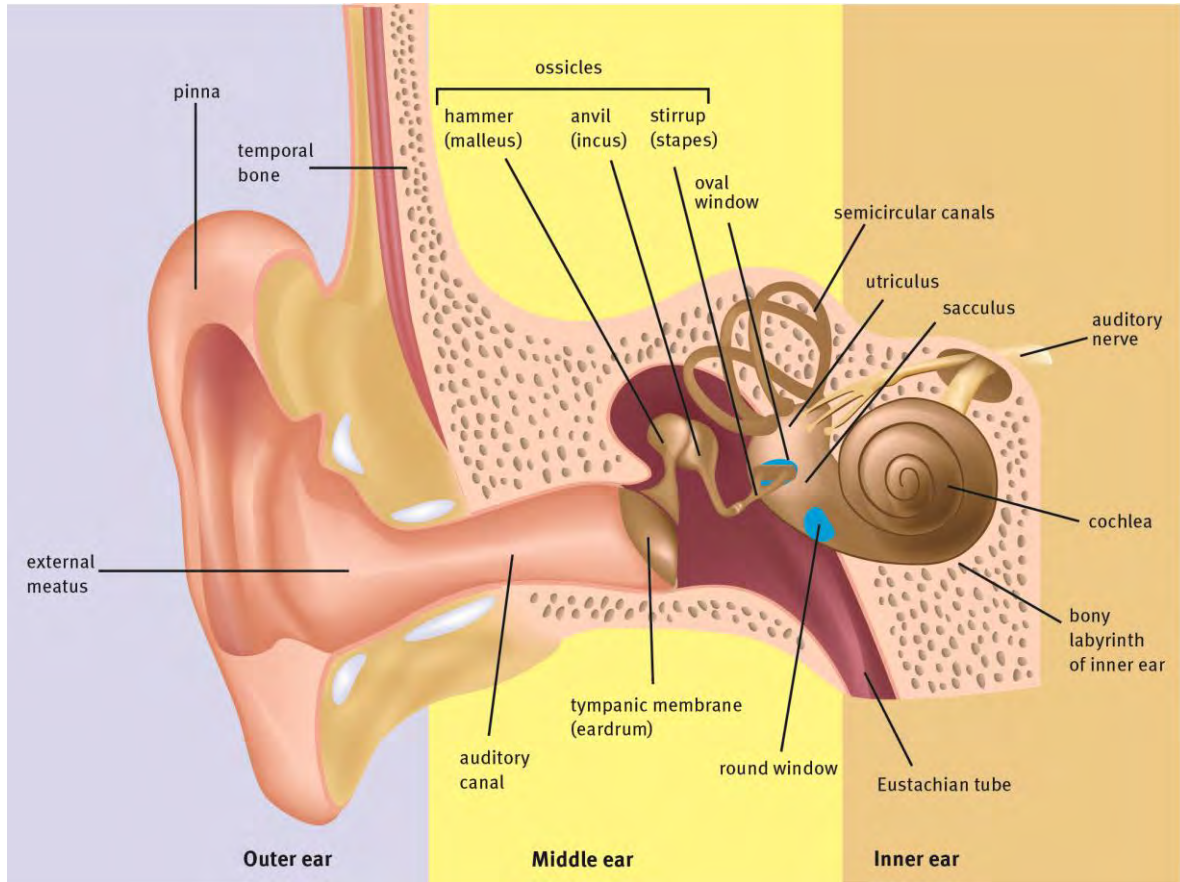

Figure 29 Internal structure of the ear

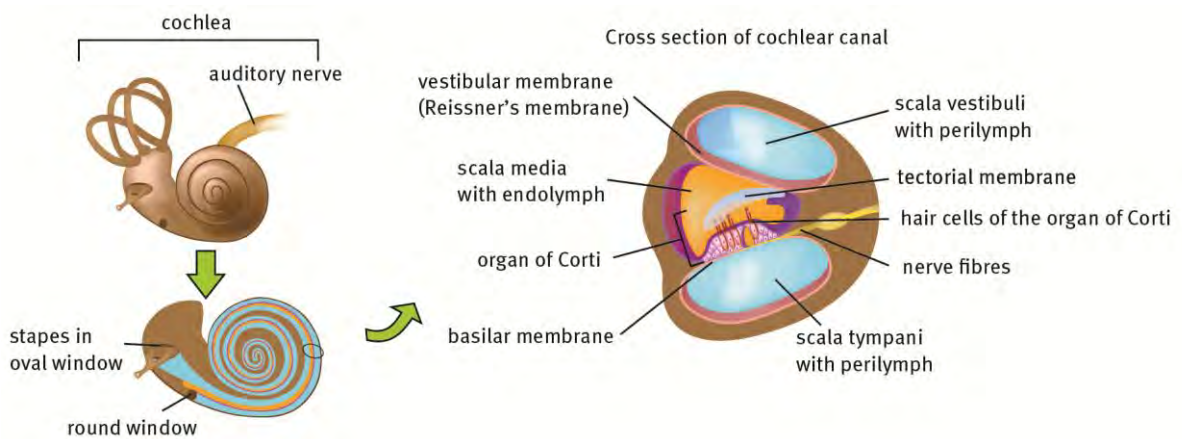

Figure 30 Internal structures of the ear

10.1 Hearing

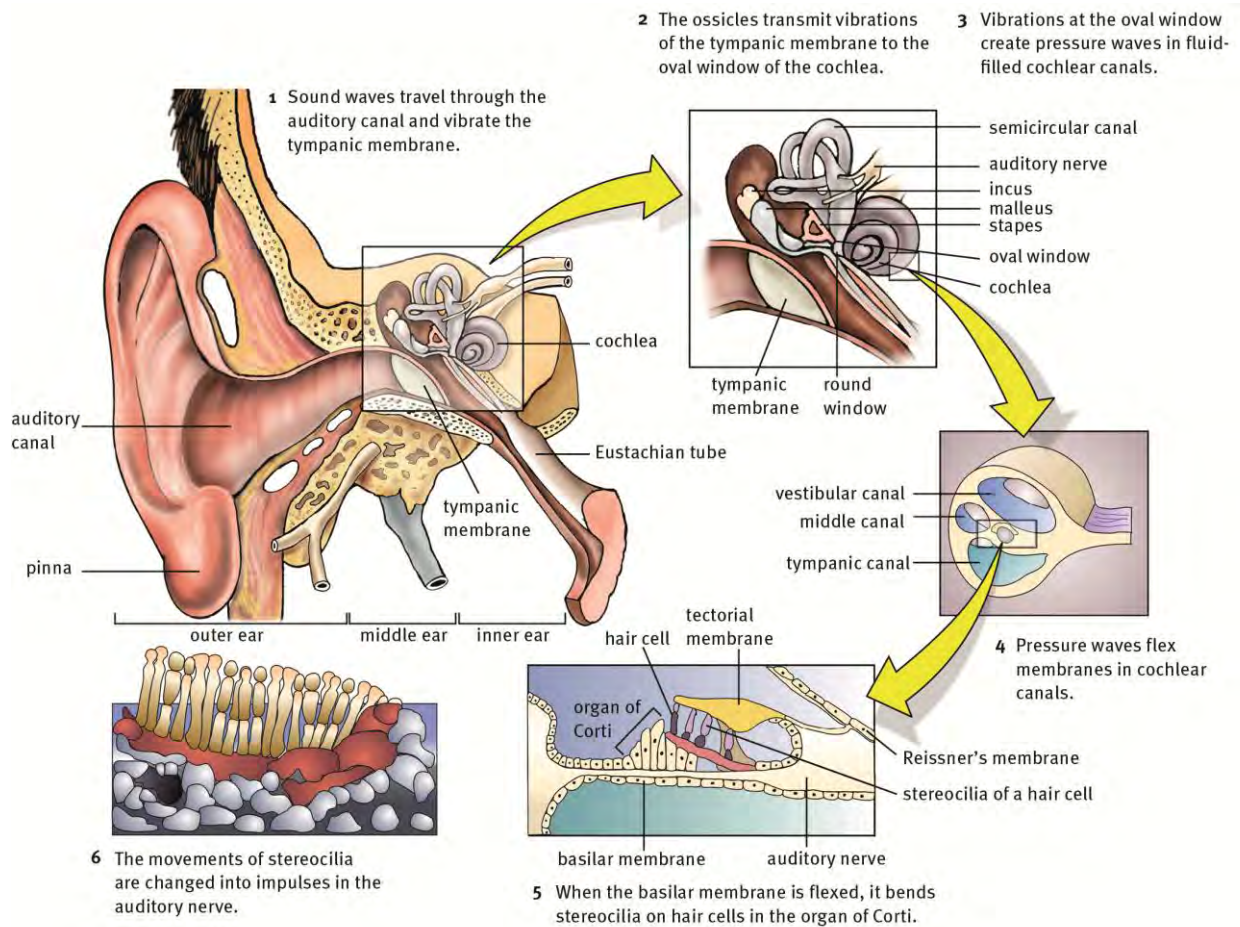

Figure 31 Hearing

10.2 Balance

Table 17 The function of the human ear in balance and equilibrium	
Balance	Equilibrium
<p>Ampulla with christa Determined by ampullae and cristae in semi-circular canals.</p>	<p>Macula in utricle and sacculus Determined by maculae in utricle and sacculus.</p>

<ol style="list-style-type: none"> 1 Head moves or rotates. 2 Cristae sense movement of endolymph. 3 Cupula deflected by inertia of the endolymph and moves in the opposite direction to the movement of the head. 4 Hair cells bend. 5 Nerve impulses are generated by the amount of bending of the hair cells. 6 Impulses travel along vestibular and auditory nerves to the cerebellum, where information is interpreted. 7 The muscular movements needed are co-ordinated and balance is maintained. 	<ol style="list-style-type: none"> 1 Otoliths in the maculae are sensitive to gravitational force. 2 When the head tilts, the otoliths are pulled downward by gravity and exert pressure on the sensory hair cells. 3 The hair cells bend. 4 Nerve impulses are generated by the amount of bending of the hair cells. 5 Impulses travel along the vestibular and auditory nerves to the cerebellum, where information is interpreted. 6 The muscular movements needed are co-ordinated and posture and equilibrium is maintained.
---	---

11 Human endocrine system

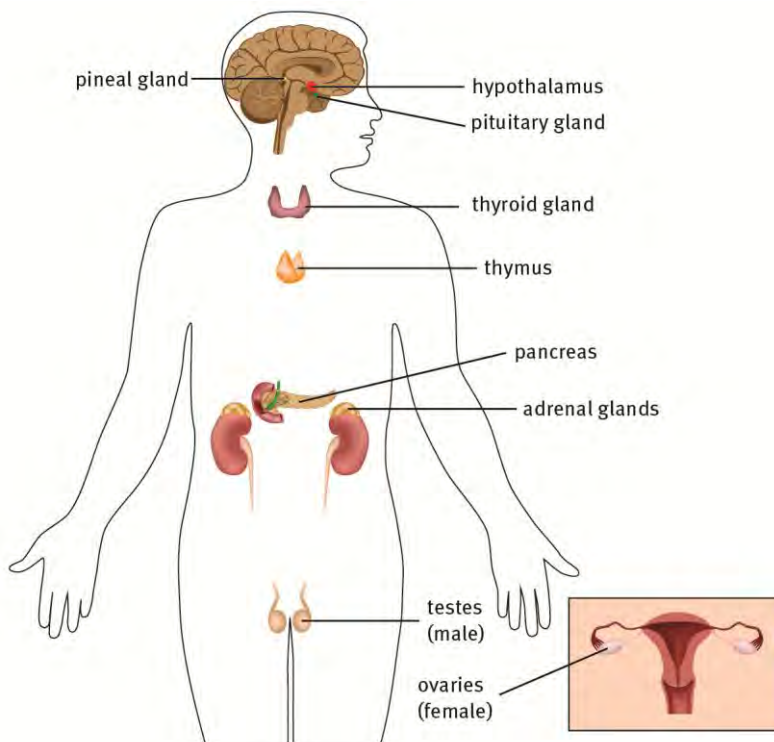

Figure 32 Human endocrine system

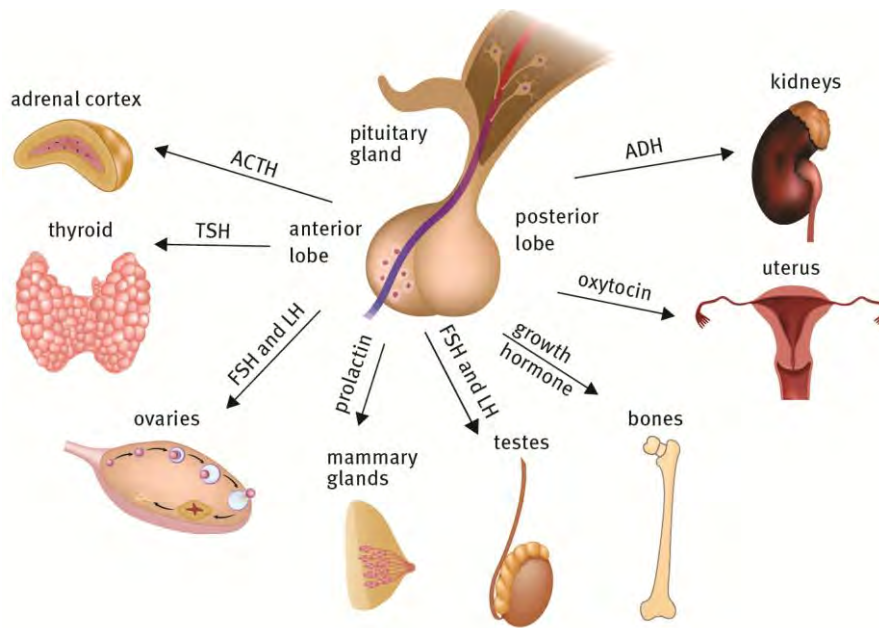

Figure 33 The role of the pituitary

11.1 Hormones

- Hormones are organic chemical messengers which are mostly protein.
- They act on target organs to regulate them and cause responses.
- Their functions are to:
 - regulate secretions from endocrine or exocrine glands
 - control growth and development of the body
 - maintain homeostasis
 - regulate metabolism and energy release
 - react to unexpected external and internal stimuli (emergency situations) through signals communicated by sensory neurons
 - control the process of reproduction.
- Hormones can act:
 - synergistically – they act together to produce a common effect
 - antagonistically – they act against each other; the effect of one cancels the effect of the other.
- Hormones may be over-secreted (hyper secretion) or under secreted (hypo secreted), resulting in certain disorders.

Table 18 A summary of hormones and the effects of hypo/hypersecretion			
Hormone and pituitary lobe	Target area	Function	Effects of hypo/hypersecretion
Growth hormone (GH) or somatotrophic hormone (STH) Anterior lobe	Cells, mainly bone and muscles	Regulates overall growth	<i>Hypo:</i> Dwarfism in children <i>Hyper:</i> Gigantism in children, acromegaly in adults
Thyroid stimulating hormone (TSH) Anterior lobe	Thyroid gland	Stimulates thyroid gland to secrete thyroxin	<i>Hypo:</i> Cretinism in children, myxoedema in adults <i>Hyper:</i> Grave's disease
Follicle stimulating hormone (FSH) Anterior lobe	Ovaries and testes	Stimulates Graafian follicles to produce ova and testes to produce sperm	<i>Hypo:</i> Failure of sexual maturation <i>Hyper:</i> No distinct effects
Prolactin	Mammary glands	Stimulates mammary glands to secrete milk (lactation)	<i>Hypo:</i> No milk secretion <i>Hyper:</i> Excess milk secretion
Luteinising hormone (LH) Anterior lobe in females; Interstitial cell stimulating hormone (ICSH) Anterior lobe in males	Ovaries and testes	Stimulates ovaries to start ovulation; produce oestrogen; develop the corpus luteum after ovulation; Stimulates testes to secrete testosterone	<i>Hypo:</i> Failure of sexual maturation <i>Hyper:</i> No distinct effects
Adreno-cortico trophic hormone (ACTH)	Adrenal gland	Controls secretions of the adrenal cortex	<i>Hypo:</i> Under-secretion of adrenalin and aldosterone <i>Hyper:</i> Over-secretion of adrenalin and aldosterone
Antidiuretic hormone (ADH), made by the hypothalamus and stored in the posterior lobe	Kidneys	Stimulates cells of distal convoluted tubule and collecting duct of nephrons in kidney to be permeable and lose water to blood capillaries of medulla (osmoregulation)	<i>Hypo:</i> Diabetes insipidus <i>Hyper:</i> Excess water retention
Oxytocin, made by the hypothalamus and stored in the posterior lobe	Uterus	Stimulates contractions of uterine wall during childbirth	

11.2 Hypothalamus and pituitary gland: anti-diuretic hormone

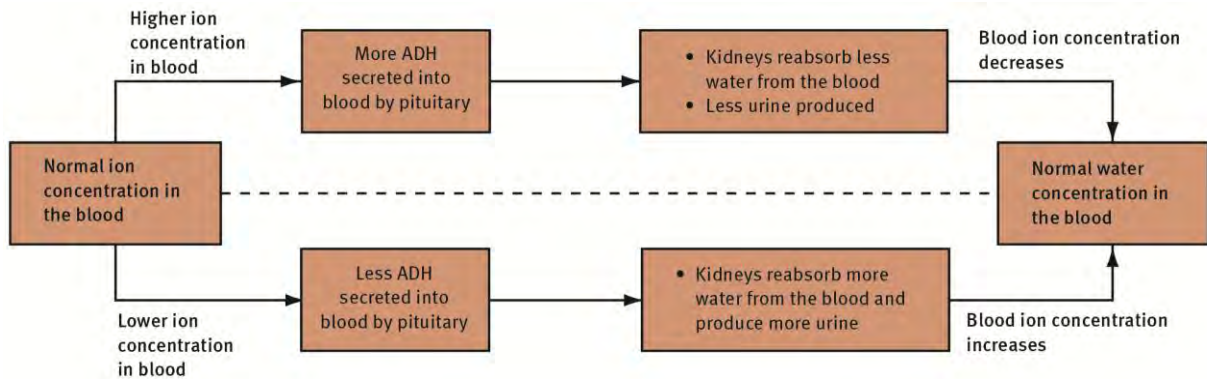

Figure 34 The regulation of salt by ADH

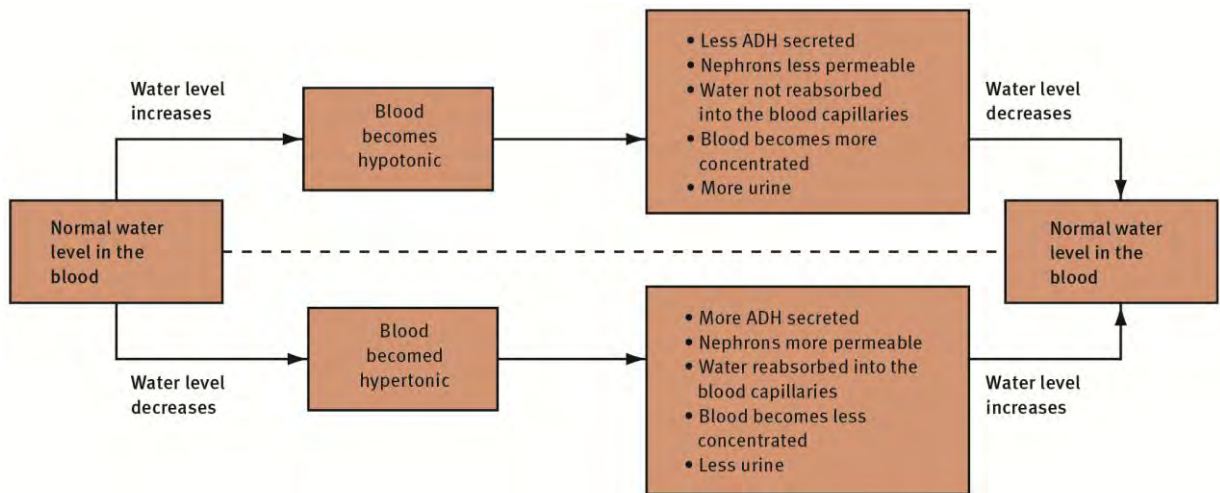

Figure 35 Regulation of water through ADH negative feedback

11.3 The thyroid gland: thyroxin

- Iodine is essential for thyroxin activity; found in iodised salt and fish.
- A goitre is formed without it.
- Thyroxin has several important functions. It:
 - controls energy production and the basal metabolic rate of all cells
 - increases the activity of the nervous system
 - increases cardiac output, heart metabolism rate and heart beat rate
 - affects physical and mental growth and sexuality
 - affects the gastrointestinal system.
- Thyroxin is associated with positive and negative feedback mechanisms between thyroid stimulating hormone and thyroxin.

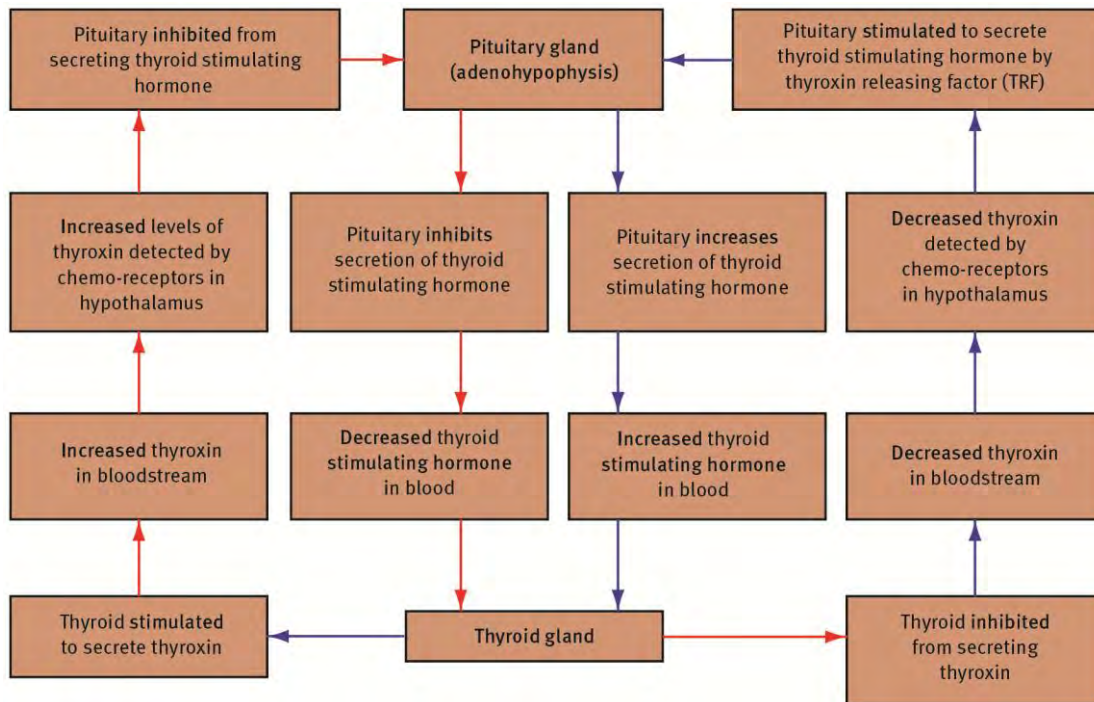

Figure 36 Negative feedback between the hypophysis and thyroid gland

11.4 The pancreas: insulin and glucagon

- The pancreas regulates blood glucose level.
- In the pancreas, the Islets of Langerhans contains two groups of cells: the alpha cells secrete glucagon; and the beta cells secrete insulin.
- Insulin decreases the amount of glucose in the blood. Excess glucose in the blood is converted to glycogen and stored in the liver.
- Glucagon increases the amount of glucose in the blood. Glycogen in the liver is converted into glucose and increases the blood glucose level.

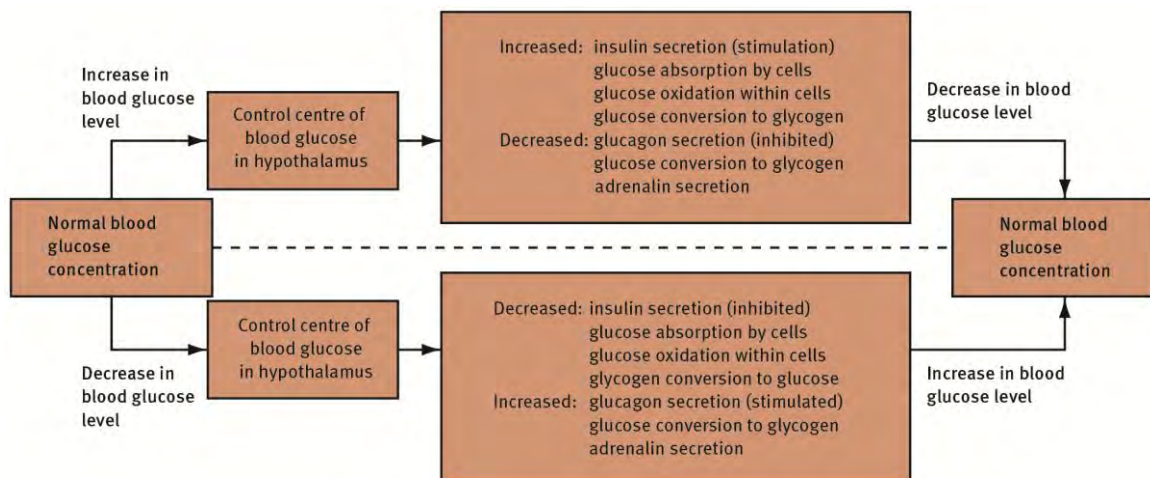

Figure 37 Negative feedback between insulin and glucagon

11.5 The adrenal glands: adrenalin and aldosterone

- Aldosterone performs two main functions. It:
 - regulates the amount of salt in the blood
 - acts with anti-diuretic hormone (ADH) to bring about a water balance in the body.
- Adrenalin functions by:
 - increasing breathing rate and depth for increased oxygen uptake
 - speeding up the conversion of glycogen in the liver by the hormone glucagon to glucose in the bloodstream
 - accelerating the heartbeat rate and the blood pressure so that the blood carrying oxygen, glucose and thyroxin) can be carried to the skeletal muscles and the brain, quickly
 - increasing the blood vessels of the skeletal muscles, heart and brain to dilate (become wider) so that blood can be taken to these parts
 - decreasing the blood vessels of the digestive system and skin to constrict (become narrower) so that less blood is sent to these parts making more blood available for the heart, muscles and brain
 - increasing the metabolic rate of the cells in the muscles and brain so that more energy can be released by cellular respiration for muscular and brain activity
 - increasing skeletal muscle tone and sweating for easier functioning
 - stimulating the release of more cortisone
 - causing pupils to dilate.

11.6 Feedback mechanisms

The endocrine system uses chemical hormonal feedback mechanisms to control the amount of hormone secreted.

- Positive feedback mechanisms cause continued or increased secretion.
- Negative feedback mechanisms cause decreased secretion.

12 Homeostasis

Homeostasis maintains a constant internal environment, in spite of continuous changes in the external environment, so that the cell can function properly through the action of hormones. A homeostatic system requires three components for maintaining balance:

- receptor (sensory neurons and organs)
- a control centre (brain and nervous system)
- an effector (endocrine glands, hormones and body organs).

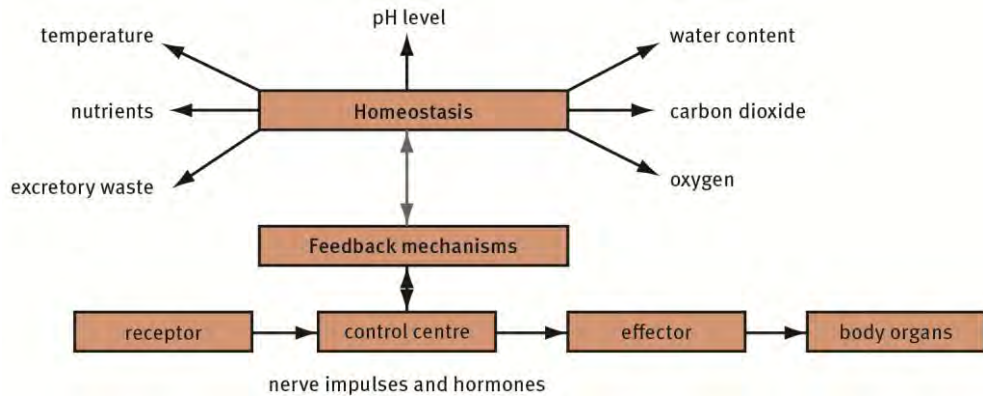

Figure 38 Negative feedback between insulin and glucagon

13 Thermoregulation

- Thermoregulation involves a variety of adaptations and processes that are involved in maintaining the body temperature of an organism with respect to the temperature fluctuations in the external environment.
- The skin plays an important role in thermoregulation in humans.

Table 19 Human skin structural adaptations and their functions

Structural adaptations	Functions
Sebaceous glands	<ul style="list-style-type: none"> • secrete antiseptic sebum • keep skin supple • prevents dehydration
Malpighian layer	<ul style="list-style-type: none"> • contains melanin pigment that protects the skin and the body against ultra-violet rays
Blood vessels: arteries, veins, capillaries	<ul style="list-style-type: none"> • carry oxygen to the skin • remove waste materials from skin • temperature regulation through dilation and constriction
Cornified layer	<ul style="list-style-type: none"> • contains dead cells • prevents entry of bacteria • protects against injuries • protects against desiccation
Sweat glands	<ul style="list-style-type: none"> • produce sweat that causes cooling during hot conditions, through evaporation
Hairs in hair follicles and erector muscles	<ul style="list-style-type: none"> • help in temperature regulation through position of the hairs to a lesser extent
Sensory neurons	<ul style="list-style-type: none"> • sensitive to environmental changes: heat, touch, pressure etc • respond to adverse circumstances
Subcutaneous fat	<ul style="list-style-type: none"> • acts as an insulator that prevents heat loss • acts as a shock absorber

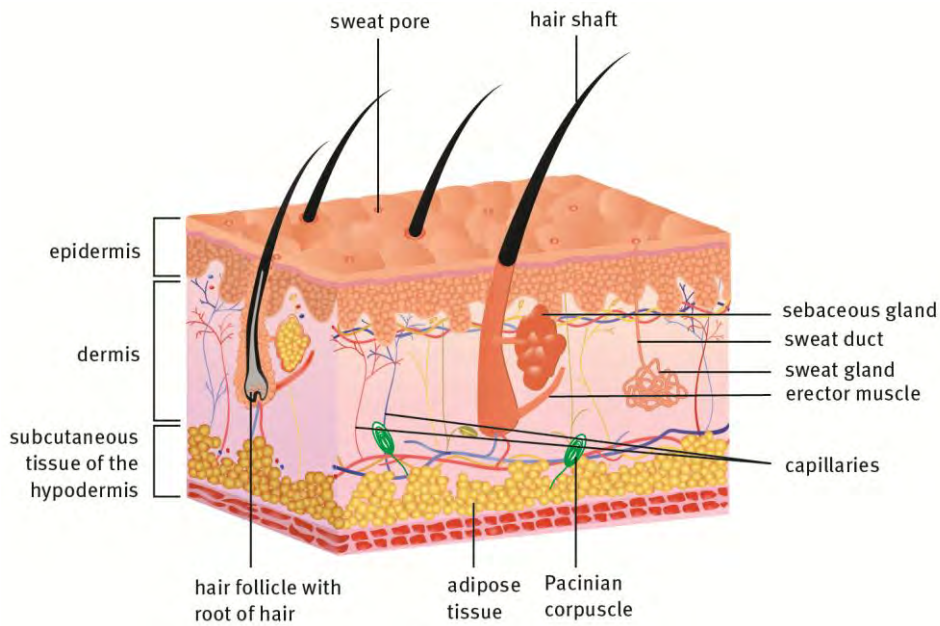

Figure 39 Internal structure of human skin

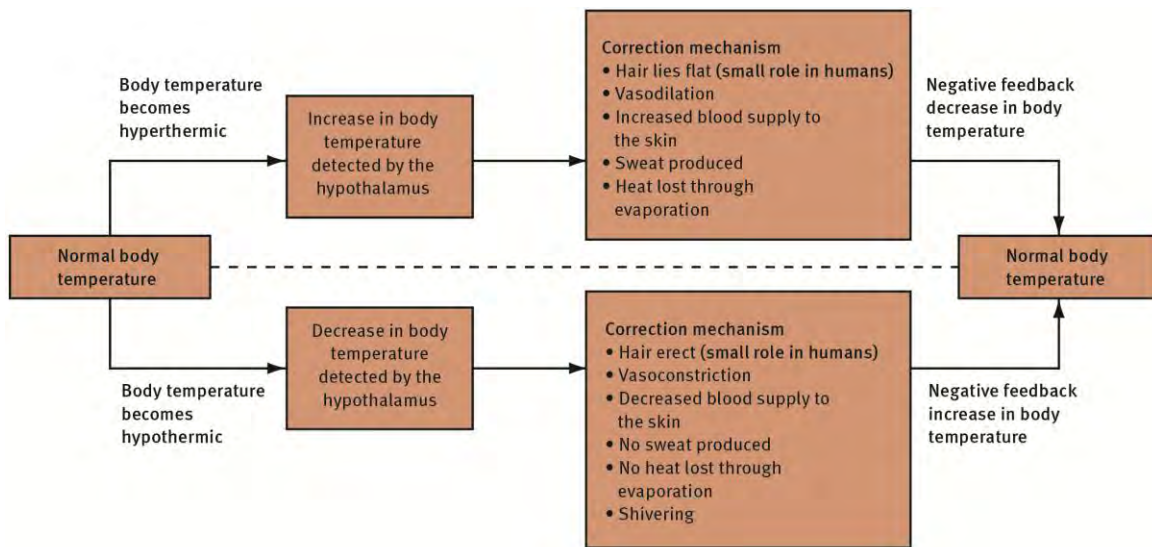

Figure 40 Thermoregulation in humans

Table 20 Temperature regulation and the skin	
High temperature (hyperthermia)	Low temperature (hypothermia)
Thermoreceptors (heat) in the skin send messages to the hypothalamus	Thermoreceptors (cold) in the skin send a message to the hypothalamus
Vasodilation – arterioles dilate, more blood enters the skin capillaries	Vasoconstriction – arterioles constrict, less blood enters the skin capillaries

Sweating – sweat glands secrete sweat that assists water loss through evaporation	Shivering – rapid contraction and relaxation of skeletal muscles and heat produced by cellular respiration
Hair flattened – no air trapped near the skin surface (to a lesser extent in humans)	Hair erect – traps warm air near the skin surface (to a lesser extent in humans)
Heat lost to maintain the body core temperature	Heat retained to maintain the body core temperature

14 Plant responses to the environment

- Plants have hormones that are responsible for co-ordinating growth and reactions to external stimuli.
- The five main groups of plant growth substances are: auxins, gibberellins, cytokinins, abscisic acid and ethylene.
- Tropisms are slow plant movement responses either towards (positive tropism) or away from (negative tropism) the source of a stimulus.
- Important tropisms found in plants are:
 - phototropism – a growth response towards light
 - geotropism – a growth response towards gravity
 - nastic movement (sleep movements) – changes in position of leaves and petals, such as in flowers that close up at night; the response is not in a specific direction
 - stomatal opening/closing – controlled by light and photosynthetic products.

Table 21 Three main plant hormones and their functions

Hormone	Effect
Auxins	Apical dominance Phototropism and geotropism Prevents leaves dying and fruit falling Cell enlargement, cell division, growth and differentiation
Gibberellins	Makes plants grow taller Encourages germination of seeds, flowering and fruit development
Abscisic acid	Slows down growth Encourages leaf senescence and fruit fall Closes stomata

14.1 Phototropism and geotropism

- Positive phototropism – growth of stems towards light.
- Negative phototropism – growth of roots away from light.
- Positive geotropism – root growth towards the centre of gravity.
- Negative geotropism – shoot growth away from the centre of gravity.

14.2 Weed control using growth hormones

Natural and synthetic plant hormones (regulators), such as auxins, are manufactured for applied functions in agriculture, horticulture, and biotechnology. They are very useful for weed control.

14.3 Plant defence mechanisms

- Plants need to protect their biomass from being eaten by herbivores, or invaded by pathogens.
- Plants need to divide their resources between growing and defending themselves.
- To defend themselves plants make structural or internal defence compounds. These range from natural chemical defences to thorns.
- Bio-engineered plant defences are created by humans.

Questions

Question 1

Various answers are provided to each question. Choose the correct answer. Only write the letter of the answer you select next to the question number.

- 1.1 Which statement applies to grey and white matter, respectively?
- A Grey matter has cell bodies and dendrites; white matter contains myelinated nerve fibres.
 - B Grey matter is older; white matter is recently formed.
 - C Grey matter consists of unmyelinated nerve fibres; white matter has both myelinated and unmyelinated nerve fibre.
 - D Grey matter has nerve fibres; white matter contains cell bodies. (2)
- 1.2 Which of the following hormones function antagonistically with regard to the effect they have on the target organ?
- A glucagon and secretin
 - B glucagon and adrenaline
 - C insulin and glucagon
 - D insulin and secretin (2)

Use the following diagram of a section through a human sense organ to answer questions 1.3 and 1.4.

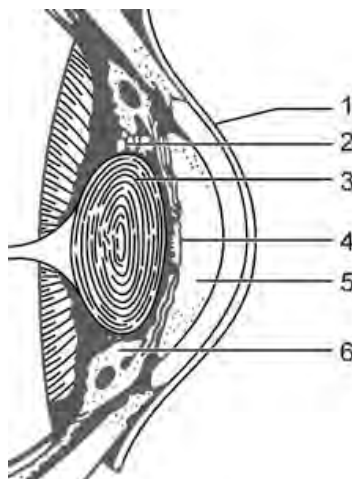

- 1.3 Accommodation makes use of structures:
- A 2, 3 and 6
 - B 3, 4 and 6

- C 1, 2 and 5
- D 1, 4 and 5 (2)
- 1.4 Rhodopsin is found in the ...
- A aqueous humour
- B iris
- C retina
- D ora serrata (2)
- 1.5 Which path does an incoming light ray follow through the eye?
- A cornea → conjunctiva → aqueous humour → lens
- B cornea → vitreous humour → lens → aqueous humour
- C cornea → lens → aqueous humour → retina
- D cornea → aqueous humour → lens → vitreous humour (2)
- 1.6 An elderly lady suffered a stroke. This caused total paralysis to the right side of her body because ...
- A the left lobe of her cerebellum was damaged.
- B the right lobe of her cerebellum was damaged.
- C the left motor area of her cerebral cortex was deprived of oxygen and nutrients.
- D the right motor area of her cerebral cortex was deprived of oxygen and nutrients. (2)
- 1.7 Seedlings of *Avena spp.* (oats) were germinated in the dark. Their coleoptiles were half painted with ink as indicated in the diagram. They were then subjected to a single, constant light stimulus.

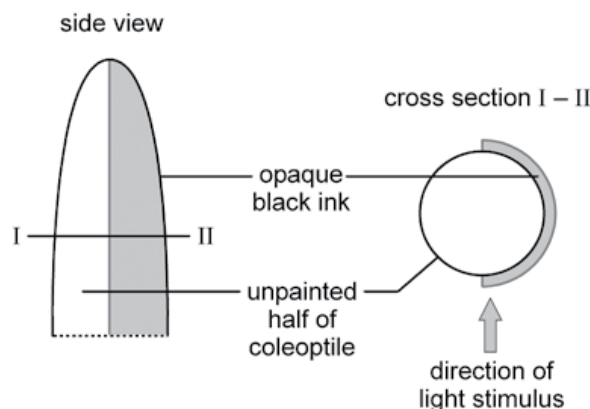

Growth of the coleoptiles is indicated by which of the following direction arrows?

- A ←: B ↓: C ↙: D ↖ (2)

- 1.8 The THREE hormones directly involved in the regulation of the glucose concentration in human blood, are ...
- A thyroid-stimulating hormone, adrenalin, glucagon
 - B insulin, glucagon, adrenalin
 - C adrenalin, insulin, thyroxin
 - D insulin, secretin, thyroxin
- (2)

Questions 1.9–1.11 refer to the diagram of part of a human sense organ.

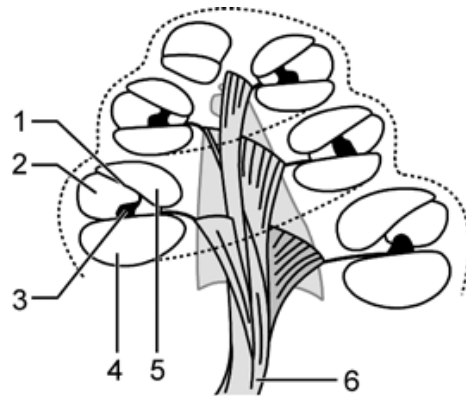

- 1.9 Structure 4 is the ...
- A cochlea
 - B scala media
 - C scala vestibule
 - D scala tympani
- (2)
- 1.10 The structure that is filled with endolymph, is ...
- A 2
 - B 3
 - C 4
 - D 5
- (2)
- 1.11 Structure 3 refers to the ...
- A membrane of Reissner
 - B tympanic canal
 - C auditory canal
 - D organ of Corti
- (2)

Study this diagram and answer questions 1.12 and 1.13.

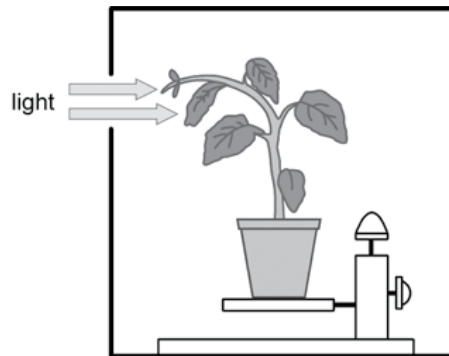

- 1.12 Which one of these steps can be carried out as a control for this experiment?
- (1) Seal the opening in the dark box.
 - (2) Rotate a similar plant on a clinostat in a dark box.
 - (3) Take the plant outside the box and expose it evenly to light.
 - (4) Rotate a similar plant on a clinostat with no box.
- A Only step 1
- B Only step 2
- C Steps 1 and 2
- D Steps 1, 3 and 4 (2)
- 1.13 The reaction of the plant in the experiment happens because growth substances ...
- A stimulate cell elongation on the shade side.
 - B inhibit cell elongation on the shade side.
 - C are only formed in the presence of light.
 - D cannot function in the dark. (2)
- 1.14 A seed was germinated in peat and sand. The container in which it was growing was then put on its side, as shown, for 24 hours. The container was then turned through a further 90° so that it stood on the gauze for a further 24 hours. The seedling was now extracted.

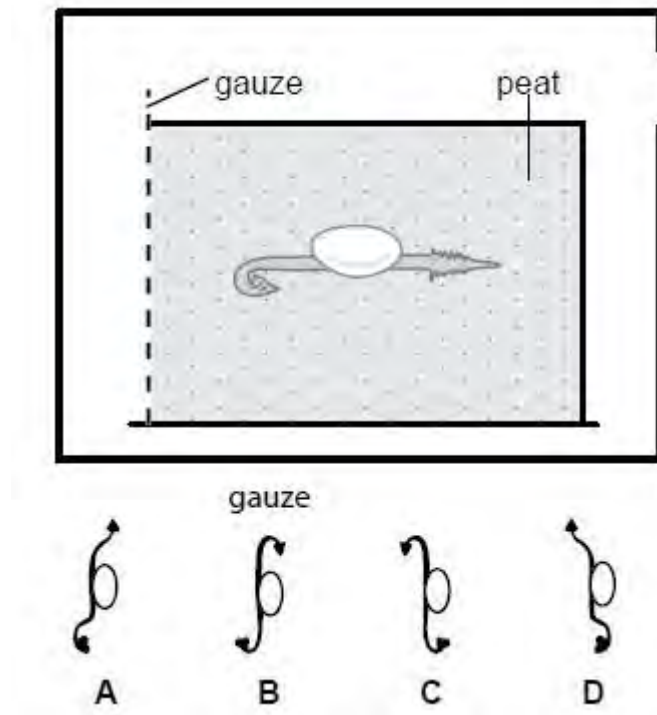

Which sketch most closely resembles the appearance of the seedling? (2)

Question 2

Use the correct scientific terms when answering these questions.

- 2.1 The narrow strip of tissue which joins the two hemispheres of the cerebellum.
- 2.2 Maintaining a constant internal environment.
- 2.3 The abnormality in a mentally retarded person due to a deficiency of thyroxin during the critical period of brain development.
- 2.4 Process of growing tissues from tissue samples in vitro.
- 2.5 A muscular movement or a glandular action which is caused by a stimulus without the person being aware of it or controlling it.
- 2.6 The strong, tough membrane on the outside of the brain.
- 2.7 The hormone that results in exophthalmic goitre from over-secretion (hyper secretion).
- 2.8 The fluid that fills the subarachnoid space surrounding the brain. (8)

Question 3

Indicate whether each of the terms in COLUMN 1 applies to **A only**, **B only**, **both A and B**, or **none** of the items in COLUMN 2. Write A only, B only, both A and B, or none next to the question number.

Column 1		Column 2	
3.1	Genetic counselling	A	Amniocentesis
		B	Stem cell research
3.2	Tropisms	A	Cytokinin
		B	Auxin
3.3	Cell bodies	A	Grey matter
		B	White matter
3.4	Glucose homeostasis	A	Follicle Stimulating Hormone
		B	Secretin
3.5	Sensory receptors	A	Ruffini
		B	Meissner
3.6	Myopia	A	Elongated eyeball
		B	Convex lens of glasses
3.7	Balance and equilibrium	A	Crista
		B	Macula
3.8	Distant objects	A	Lens more convex / thicker
		B	Ciliary muscles relax
3.9	Pancreas	A	Insulin
		B	Adrenalin
3.10	High temperature	A	Sweating
		B	Vasoconstriction

(10)

Question 4

Study the diagram of a neuron and answer the questions that follow.

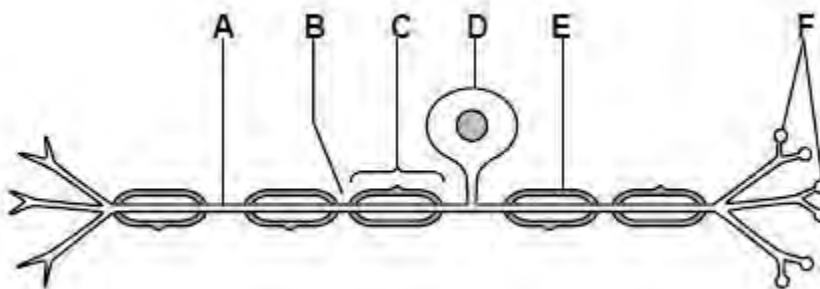

- 4.1 Does the diagram represent a motor or a sensory neuron? Give ONE reason for your answer. (2)
- 4.2 Provide labels for the parts A, B and C. (3)
- 4.3 State the functions of the following structures:
 - 4.3.1 D
 - 4.3.2 E
 - 4.3.3 F (3)

Question 5

Study the diagram below and answer the questions.

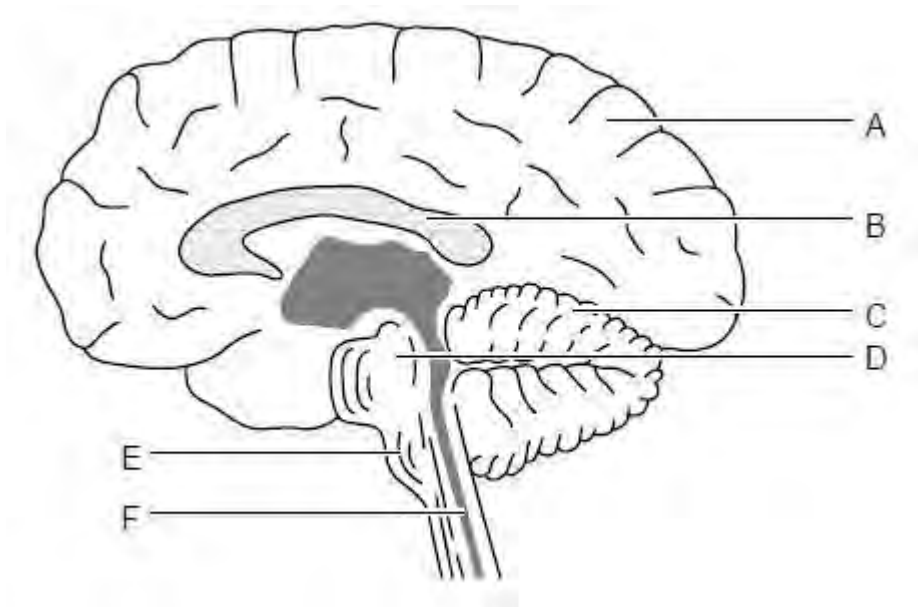

- 5.1 Label the structures A to F. (6)
- 5.2 Give SIX functions of the fluid in structure F. (6)
- 5.3 What is the meaning of the term 'ataxia' with reference to structure C? (2)
- 5.4 If structure C is damaged (injured), what effect does this have on a human being? (6)

Question 6

Read the following passage carefully and answer the questions.

Insulin nasal sprays

Spraying insulin up the nostrils from an aerosol may soon replace injections for the treatment of at least some forms of diabetes. Insulin currently has to be injected into the blood because it is broken down in the digestive system if taken orally (by mouth). The results showed that the insulin given nasally was absorbed more rapidly than injected insulin. One drawback is that the nasal spray uses ten times more insulin than an injection to produce the same effect. However, aerosol cans are cheaper than syringes. A can lasts for a week while syringes are thrown away daily.

- 6.1 Mention ONE medical advantage and ONE medical disadvantage of the use of a nasal spray to administer insulin. (2)
- 6.2 Are injections or sprays cheaper to administer? (2)
- 6.3 Explain what would happen to the blood sugar level of a diabetic, and its associated dangers, if he/she:
 - 6.3.1 forgot to inject him/herself? (3)
 - 6.3.2 ate three large bars of chocolate (3)

Question 7

Study the diagram of a longitudinal section of the human brain, a cross-section of the spinal cord and the right leg.

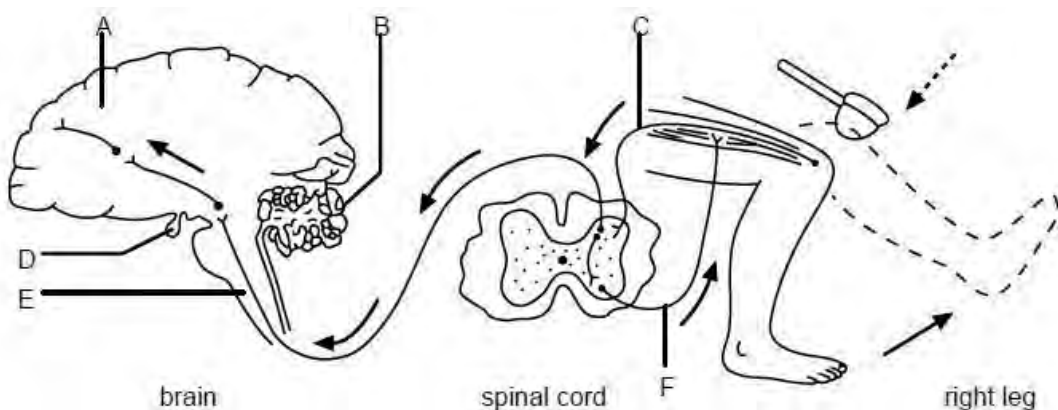

- 7.1 Identify the parts A, B and E. (3)
- 7.2 What will be the effect on the body if part B is damaged? (2)
- 7.3 Give the LETTER and the NAME of the part which secretes TSH. (2)

- 7.4 What is the function of TSH? (2)
- 7.5 Describe the reflex action shown in the diagram. (13)

Question 8

Read the following paragraph and answer the questions that follow.

The use of meprobamate in the treatment of heroin withdrawal symptoms

Addiction to narcotic drugs is common in the world. Numerous addicts spend between 75% and 90% of their income on heroin, and are, therefore, unable to afford adequate food, clothing and shelter for themselves and their families. The occurrence of withdrawal symptoms following the ending of drug intake is a factor which promotes the further use of heroin. It is felt that if the withdrawal symptoms could be prevented many drug users might be induced to stop using narcotics. Many agents and methods have been tried to decrease the severity of the abstinence syndrome. These include substitution therapy with meprobamate and placebo administration.

In an investigation a comparison was done on the effect of meprobamate and placebo administration on the patellar reflex response during the heroin abstinence syndrome. Heroin makes the patellar/knee reflex slower than usual. The reflex response was graded as:

Absent (0), Very sluggish (1), Sluggish (2), Normal (3), Rapid (4), Very rapid (5).

The results of the investigation are shown in the table below.

Comparison of the effect of meprobamate and placebo administration					
Day	1	2	3	4	5
Patellar response: meprobamate	0,5	1,0	0,7	1,0	1,3
Patellar response: placebo	3,7	3,4	3,3	3,2	3,2

- 8.1 Why was the knee-jerk / patellar reflex used in this investigation? (4)
- 8.2 What negative impact does drug addiction have on families? (3)
- 8.3 What is a placebo? (2)
- 8.4 Formulate an hypothesis for this investigation. (2)
- 8.5 List the dependent and independent variables. (2)
- 8.6 Draw a line graph of the data in the table and also indicate the normal level. (15)

TOTAL MARKS: 130

Answers to Questions

Question 1

- | | | |
|------|------|-----|
| 1.1 | A ✓✓ | (2) |
| 1.2 | C ✓✓ | (2) |
| 1.3 | A ✓✓ | (2) |
| 1.4 | C ✓✓ | (2) |
| 1.5 | D ✓✓ | (2) |
| 1.6 | C ✓✓ | (2) |
| 1.7 | C ✓✓ | (2) |
| 1.8 | B ✓✓ | (2) |
| 1.9 | D ✓✓ | (2) |
| 1.10 | A ✓✓ | (2) |
| 1.11 | D ✓✓ | (2) |
| 1.12 | B ✓✓ | (2) |
| 1.13 | A ✓✓ | (2) |
| 1.14 | B ✓✓ | (2) |

Question 2

- | | | |
|-----|-----------------------|-----|
| 2.1 | vermis ✓ | |
| 2.2 | homeostasis ✓ | |
| 2.3 | cretinism ✓ | |
| 2.4 | tissue culture ✓ | |
| 2.5 | reflex action ✓ | |
| 2.6 | dura mater ✓ | |
| 2.7 | thyroxin ✓ | |
| 2.8 | cerebrospinal fluid ✓ | (8) |

Question 3

- | | | |
|-----|----------|--|
| 3.1 | A only ✓ | |
| 3.2 | B only ✓ | |
| 3.3 | A only ✓ | |

- 3.4 Neither A nor B ✓
- 3.5 Both A and B ✓
- 3.6 Both A and B ✓
- 3.7 Both A and B ✓
- 3.8 A only ✓
- 3.9 A only ✓
- 3.10 A only ✓ (10)

Question 4

- 4.1 Sensory neuron ✓ Unipolar (monopolar) neuron / dendrites not around cell body ✓ (2)
- 4.2 A – Dendron, ✓ B – node of Ranvier, ✓ C – Schwann cell ✓ (3)
- 4.3.1 D – Cell body contains nucleus and Nissl granules; controls functions of the cell. ✓
- 4.3.2 E – Myelin sheath assists with transmission of impulses (signals). ✓
- 4.3.3 F – Synaptic knob secretes acetylcholine (neurotransmitter) that transmits impulses across the synapse. ✓ (3)

Question 5

- 5.1 A – cerebrum, ✓ B – corpus callosum, ✓ C – cerebellum, ✓ D – mid-brain, ✓ E – Pons Varolii, ✓, F – central canal ✓ (6)
- 5.2 Acts as a cushion ✓.
Protection of delicate structures. ✓
Is a shock absorber. ✓
Supplies nervous tissue with nutrients. ✓
Provides oxygen for cellular respiration. ✓
Removes metabolic waste products, like CO₂. ✓ (6)
- 5.3 Lack ✓ of muscle co-ordination due to damage / injury / trauma ✓ to the cerebellum (2)
- 5.4 lack of balance ✓
uncontrolled irregular movements ✓
staggering / exaggerated walk ✓
speech becomes impaired / slurred ✓
disorientation and unable to determine direction ✓

no muscle tension / fine motor control ✓ (6)

Question 6

- 6.1 Advantage: It is absorbed more rapidly than injected insulin. ✓ Disadvantage: Nasal spray uses ten times more insulin than an injection. ✓ (2)
- 6.2 Spray is cheaper to administer. ✓✓ (2)
- 6.3.1 Blood glucose level will increase; ✓ large amounts of glucose will be passed out with the urine, ✓ which can lead to kidney failure. ✓ (3)
- 6.3.2 Blood sugar will increase rapidly; ✓ there will be no insulin to convert glucose to glycogen ✓ and the urine will have high levels of glucose. ✓ (3)

Question 7

- 7.1 A – cerebrum / brain, ✓ B – cerebellum, ✓ E – medulla oblongata ✓ (3)
- 7.2 Lack of muscle control / lack of co-ordination / bad posture / upset equilibrium ✓✓ (2)
- 7.3 D ✓ – pituitary gland / hypophysis ✓ (2)
- 7.4 Stimulates the thyroid gland ✓ to secrete thyroxin. ✓ (2)
- 7.5 Hammer strikes the knee ✓ stimulating the touch corpuscles / receptors. ✓ An impulse is transmitted along the dorsal root ✓ to the dorsal horn ✓ where the sensory neuron ✓ makes a synapse with an interneuron. ✓ It moves along the motor neuron in the ventral horn ✓, along the ventral root ✓ to the effector ✓, the muscles in the leg. ✓ The leg is raised upwards. ✓ At the same time an impulse moves to the brain ✓ to be interpreted. ✓ (13)

Question 8

- 8.1 A reflex is an involuntary response to a stimulus by the organism. ✓ The normal pathways of many reflexes are generally known, and the presence, absence, or exaggerations ✓ of the normal physical responses to certain stimuli are symptoms used by neurologists to determine the condition ✓ of the neural pathways involved. The patellar reflex will become more rapid as the heroin concentration decreases in the person's body. ✓ (4)
- 8.2 Unable to afford adequate food, ✓ clothing ✓ and shelter ✓ for themselves and their families. (3)
- 8.3 Placebo (control) is something prescribed for a patient that contains no medicine, ✓ but is given for the positive psychological effect ✓ it may have because the patient believes that he or she is receiving treatment. (2)

TOPIC 5

Responding to the environment

8.4 The severity of abstinence syndrome decreases ✓ when meprobamate is given to the patient during the withdrawal time. ✓

OR

The reaction of the normal physical responses ✓ will become normal in the abstinence syndrome when addicts are given meprobamate. ✓ (2)

8.5 Dependent variable – reaction of knee reflex / patellar reflex. ✓ (1)

Independent variable – time in days / meprobamate or placebo. ✓ (1)

8.6

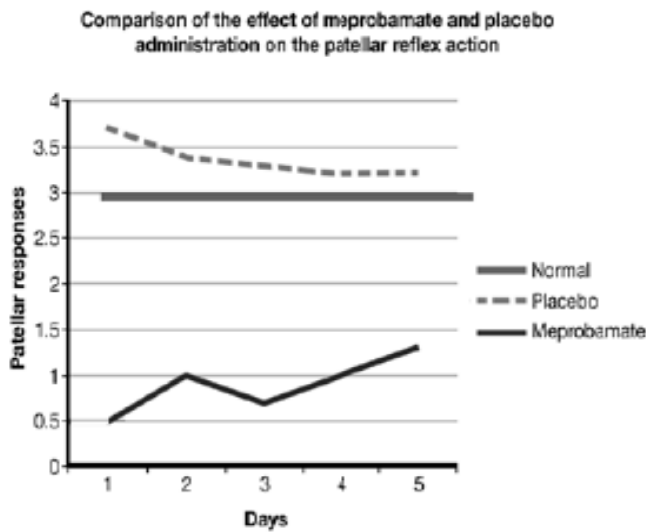

Mark allocation:

Heading ✓✓

Correct label for x-axis ✓

Two sets of data used ✓

Correct label for y-axis ✓

Appropriate scale for x-axis ✓

Appropriate scale for y-axis ✓

Line graph ✓✓

6 accurately plotted points ✓✓✓✓✓✓

(15)

TOTAL MARKS: 130

Overview

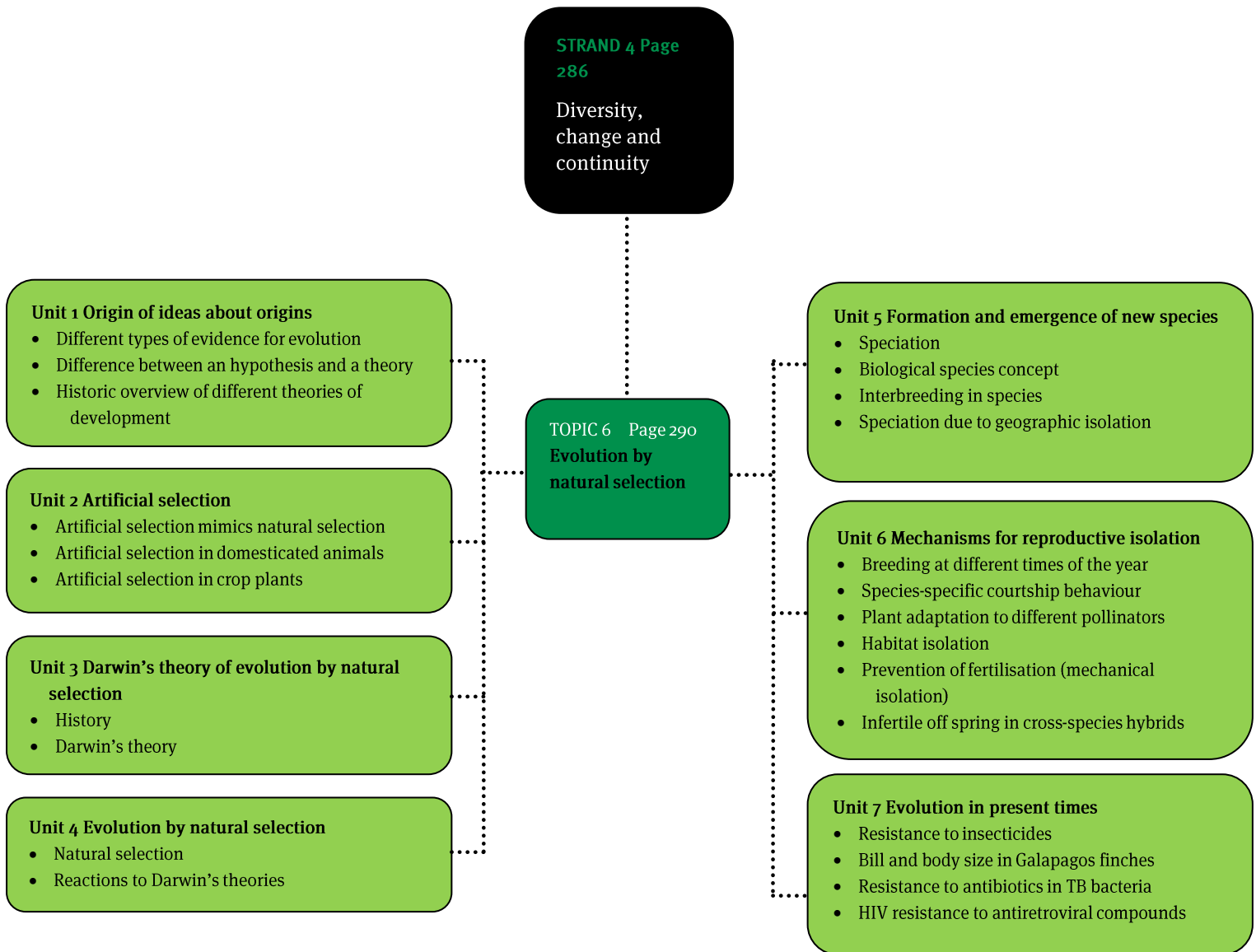

Units 1 to 7

1 Different types of evidence for evolution

- Fossil record – Fossils are the preserved remains (for example bones and teeth) or impressions (like footprints) of organisms that lived in the past. By studying fossils, palaeontologists can develop a good understanding of past life forms from collected fossil remains of different species and their intermediate forms, as well as, transitional organisms. Fossils are dated using radiometric methods.
- Modification by descent – Genes are passed on from one generation to the next and these genes are constantly changing. Organisms undergo changes in order to adapt to the changing environment. Organisms that develop from a common ancestor should have certain characteristics in common.
- Biogeography – Species tend to be more closely related to the species from the same area, than to other species with the same lifestyle or form but living in different areas.
- Genetics – Similarities and differences in the biochemistry and molecular biology of various organisms; their genetic code as determined by the sequence of nucleotides in their DNA and mRNA.
- Embryology – Embryonic structures develop into homologous structures with different functions; ‘ontogeny recapitulates phylogeny’. This means that, during embryonic development, an organism goes through the same successive stages the species did in its evolutionary development.
- Anatomy – Animals that have developed from a common ancestor should have certain characteristics in common. For example all mammals have the same skeletal elements making up their forelimbs. These forelimbs are called homologous structures arising from their strongly visible similar features and characteristics. Analogous structures are similar in function but different in structure.
- Vestigial structures – Organs or structures that seem to be unnecessary, since they do not have a clear function; remainders of more complex structures that are no longer of use or of value, for example, the appendix, coccyx and vestigial wings.
- Observed natural selection – The development of antibiotic resistance in bacteria; insecticide resistance in insects; lactose intolerance.

2 Difference between an hypothesis and a theory

- Speculation – Speculation is a calculated, logical and rational, theoretical explanation of a fact, with no testing to verify or disprove the idea.
- Hypothesis – An hypothesis is an explanation with some evidence to support it.
- Theory – A theory is an explanation with a large amount of evidence and testing to support it.
- Model – A model is a representation, usually on a smaller scale, of a structure or process. It assists us in better understanding the phenomenon, by providing an analogy.
- Principle / law – A principle or law is an explanation with a great amount of supporting evidence and it has been tested thoroughly with input and scrutiny by others. It works in almost all testable contexts.

3 Historic overview of different theories of development

- A scale of nature by Aristotle – organised life from simple to complex.
- ‘Theory of spontaneous generation’ Van Helmont (1577–1644) – Life forms appear from non-living matter – by themselves.
- ‘Divine Creation’ by Adam Sedgwick (1785–1873) and others that tried to explain the existence of fossils – Life created by the Creator for a specific purpose.
- Change in living organisms through the history of the Earth – Georges Cuvier (1769–1832) making comparisons with fossils and living life forms.
- Use and disuse of inherited, acquired characteristics causes change in living organisms, by Jean Baptiste de Lamarck – As an organism used a characteristic so its value increased and stayed within the population.
- Extraterrestrial theories – Organic precursor molecules which support life originated in outer space and came to Earth via meteorite collisions.
- The primordial soup theory by A. I. Oparin and J. B. S. Haldane (1920) – The basic building blocks of life were simple molecules which formed in the atmosphere, without oxygen; energised by lightning and dissolved by the rain from the atmosphere, creating the ‘organic soup’, from which the first living cells may have been formed.
- The theory of evolution by means of natural selection by Erasmus Darwin, Alfred Wallace and Charles Darwin (1859) – An animal adapts within its environment in order to survive.
- Punctuated equilibrium by Eldredge and Gould – species will show very little evolutionary change for most of their geological history, remaining in a state of stasis and then changing rapidly.

4 Artificial selection

Artificial selection / selective breeding – The ability of people to control the breeding of domesticated animals and crop plants for desirable characteristics.

5 Lamarckism

- The French naturalist Jean Baptiste de Lamarck was one of the first scientists to propose that organisms undergo change over time as a result of some natural phenomenon rather than divine intervention.
- According to Lamarck, a changing environment causes an organism to change its behaviour, thereby using some body parts more and others less. Over several generations, a given body part would increase in size if it was used a lot, or shrink if it was used less.
- Lamarck suggested that the giraffe got its long neck by straining to reach the leaves in a tree and those characteristics were passed on to the offspring in which continual stretching extended their necks even more.

6 Adaptation

- Darwin made it clear that in order to survive in an environment, an organism needs to adapt.
- Camouflage – looking the same as their surroundings, in their colouring and patterns; this variation influences survival and reproduction; and is inherited.
- Mimicry – The ability of an organism to copy the colours and shapes of other organisms or plant parts to prevent being eaten. These characteristics are also inherited and assist in survival and reproduction.

7 Natural selection

- When plants, animals and other organisms are under pressure from environmental factors such as food shortages, predators or overcrowding, only certain individuals will survive long enough to breed.
- These ‘fittest’ individuals have certain characteristics that they pass on to the next generation.
- As a result, living things can gradually change or evolve over long periods of time through successful populations that had strong reproductive potential and vigour.
- ‘Survival of the fittest’ is called natural selection.
- Charles Darwin explained natural selection using these ideas:
 - Variation (gene pool) of inherited characteristics – Variations exist in populations. These variations are the result of environmental factors, genetic breeding factors (genes) and mutations.

- Production of more offspring – All organisms produce more offspring than the environment can support.
- Extinction of unsuccessful adaptation; ‘survival of the fittest’ – There is competition among organisms; a struggle for existence. Those organisms best suited to the environment will survive. This is called survival of the fittest. Organisms that are well adapted to the environment will reproduce. This means that the beneficial characteristics will become more common.

8 Natural selection and genetic change within a population

Natural selection can result in a new generation having different allele ratios than the previous generation, for example, bacterial resistance to antibiotics.

9 Speciation

- A species consists of one or more reproductively fertile populations whose members interbreed to produce fertile offspring. They do not interbreed with members of other species.
- With speciation we refer to the evolution of a new species.

9.1 Speciation due to geographic isolation

- Allopatric speciation (divergent evolution) – The formation of two or more species often requires geographical isolation of subpopulations. This produces various isolated races (subspecies) that almost never occupy the same territory
- Geographic isolation – A species (populations) become separated by a physical barrier (for example a lake, mountains, sea) and each group diverge along separate evolutionary paths.
- For example, the protea family: Protea species are represented by fossil pollen found in Antarctica, and we find living examples of proteas today in Africa, Australia and South America. This tells us that proteas developed before Gondwanaland broke apart. When continental drift started to take place, different protea species developed on the different continents, due to their geographic isolation.
- Darwin’s finches are another example. As a young man of 26, Charles Darwin visited the Galapagos Islands off Ecuador. Among the animals he studied were 13 species of finch found nowhere else on Earth. Darwin observed that:
 - Some have stout beaks for eating seeds of one size or another.
 - Others have beaks adapted for eating insects or nectar.
 - One has a woodpecker-like beak, to drill holes in wood. Lacking the woodpecker’s long tongue, it uses a cactus spine to dig each insect out.
 - Another looks more like a warbler than a finch, but its eggs, nest, and courtship behaviour are like those of the other finches.

- The proximity of the various islands has permitted enough migration of Darwin's finches to enable distinct island populations to arise, yet the distances between the islands are great enough to limit interbreeding, and so distinctive subspecies (races) on the islands was made possible. The importance of allopatry is also illustrated by a fourteenth finch that lives on Cocos Island, some 800 km to the north-east of the Galapagos.
- There are further examples, like the Galapagos tortoises, flightless birds like the kiwi, and baobabs.
- Some of Madagascar's present species, such as the baobab tree, are there because they were present on Gondwanaland and were left on the island when it separated from India. Today *Adansonia* is a genus of eight species: six of these species are native to Madagascar, one (*Adansonia digitata*) to Africa, and one (*Adansonia gregorii*) to Australia.

9.2 Speciation without geographic isolation

- Sympatric speciation (convergent evolution) – The formation of species in the absence of geographical barriers, as demonstrated by the cichlid fish species in Lake Malawi.
- Speciation within a common area of the Lake is determined by:
 - ecological traits – jaw and tooth morphologies that are adapted for different modes of feeding and habitat preference
 - gender and mate selection – female fish determine the sex of their offspring and mate selection involves male colour attraction mechanisms, recognition of size and courtship behaviour
 - polygenic conflicts between autosomes and sex chromosomes – colour mutations tightly associated with female determination.

10 Mechanisms for reproductive isolation

- Reproductive isolation is an important part of speciation.
- Different species are isolated from each other by genetic and biochemical factors (which we call barriers) that block genetic mixing. We categorise these factors as pre-zygotic and post-zygotic barriers.
- Pre-zygotic barriers to speciation – Occur when different species are isolated or prevented from breeding amongst other species by genetic and biochemical factors (barriers) that block genetic mixing.
- Post-zygotic barriers prevent an organism, that develops from a hybrid zygote, from developing into a fertile adult. An example is the mule – a cross between a donkey and a horse. The mule (a hybrid) is sterile, and cannot produce offspring. Post-zygotic barriers reduce hybrid fertility and viability and support hybrid breakdown.

Table 22 Nature of prezygotic barriers to speciation	
Barrier	Nature of barrier
Habitat isolation	Two species live in different habitats
Behavioural isolation	Specific behaviour attracts the opposite sex, for instance courtship dances in spiders
Mechanical isolation	Sex organs are anatomically incompatible
Temporal isolation	Examples are seasonal differences, diurnal or nocturnal behaviour. Some animals are active during the day and others at night, which limits the chances to meet

10.1 Temporal isolation factors

- Some organisms breed at different times of the year, which is a pre-zygotic barrier.
- Two species showing hibernation and aestivation would never have the chance to mate.
- Frogs are an example of animals that show temporal isolation factors as they breed at different times if the year.

10.2 Courtship behavioural isolation factors

- The different courtship behaviours of animal species create strong powerful pre-zygotic reproductive barriers, which isolate similar species.
- Courtship behaviour, sound recognition and smell all play a role in species recognition for *Drosophila spp*, the fruit fly. The females produce chemicals called pheromones that attract males of their own species.

10.3 Plant adaptation to different pollinators

- Some plant species are adapted to be pollinated only by specific pollinator animal species.
- This is an example of mechanical isolation as the pollinators and flowers are structurally adapted to each other. The specificity of the baobab being pollinated only by bats is a good example.
- Mechanical isolation is a pre-zygotic barrier.

110.4 Prevention of fertilisation

- Mating pairs may not be able to reproduce if their genitals are not compatible.
- This is a form of mechanical isolation.
- Mechanical isolation is a pre-zygotic barrier.

10.5 Habitat isolation

- When two species live in different habitats, they will meet very seldom, if at all.
- Habitat isolation also affects parasites which are confined to the body of the host.
- Habitat isolation can be a pre-zygotic barrier that hinders species from interbreeding.
- This principle applies to all living organisms, including plants.

10.6 Infertile offspring in cross-species hybrids

- This is an example of a post-zygotic barrier.
- If a sperm cell from one species fertilises an egg cell of another species, then post-zygotic barriers will prevent the hybrid zygote from developing into a fertile adult.

11 Resistance to insecticides

- All pests can develop resistance to the insecticides which are used to control them.
- Insect pests develop resistance to insecticides. They produce large amounts of enzymes which break down the insecticide molecule, or cause a mutation of the insecticide target site, which blocks the action of the insecticide.

11.1 The use of DDT to combat malaria

- Malaria remains a major public health challenge in many parts of the world.
- DDT (from its chemical name, Dichloro-Diphenyl-Trichloroethane) is one of the best known synthetic pesticides.
- DDT has been very effective in controlling malaria.
- DDT-resistant mosquitoes resulted.
- DDT was replaced by organophosphate or carbamate insecticides, like malathion or bendiocarb.
- This is an example of present-day evolution.
- Mosquitoes resistant to DDT would survive and reproduce, while the susceptible mosquitoes would die.
- This is an example of micro-evolution in a population.

Questions

Question 1

Various answers are provided to each question. Choose the correct answer. Only write the letter of the answer you select next to the question number.

- 1.1 Which statement best describes the theory of biological evolution?
- A Over time organisms have spontaneously emerged.
 - B An animal's body parts can change over its lifetime, and these changes are then passed to the next generation.
 - C Organisms share common ancestors.
 - D Both A and C are correct. (2)
- 1.2 Charles Darwin proposed that better-adapted organisms are more likely to survive and become parents of the next generation, and because of this, populations change over time. Darwin called this process ...
- A artificial selection
 - B evolution by natural selection
 - C the founder effect
 - D genetic drift (2)
- 1.3 In many cultures men have been circumcised for many generations, yet this has had no effect on the penile foreskin of the offspring. This observation is not in line with the type of evolution that the following person(s) proposed:
- A Darwin
 - B Lamarck
 - C Mendel
 - D Sedgwick and Cuvier (2)
- 1.4 Larger islands may have greater species diversity than smaller islands because ...
- A larger islands are in the tropics.
 - B larger islands are farther from continents than smaller islands are.
 - C larger islands have more habitats than smaller islands do.
 - D larger islands have greater genetic drift than smaller islands do. (2)

- 1.5 The reproductive isolating mechanism in which two closely related species live in the same geographic area but reproduce at different times is ...
- A temporal isolation
 - B behavioural isolation
 - C mechanical isolation
 - D gamete isolation (2)
- 1.6 The bat and the bird share a common ancestor because ...
- A They both fly.
 - B They both eat insects.
 - C Wings of each are homologous.
 - D The forelimbs are homologous. (2)
- 1.7 The beak of a bird and the beak of a giant squid evolved independently and serve the same function. The beaks are ...
- A Divergent structures.
 - B Analogous structures.
 - C Homologous structures.
 - D Hybrid structures. (2)
- 1.8 Which of the following is NOT a fossil?
- A *Tyrannosaurus rex* skull, 65 million years old.
 - B Oil formed from micro-organisms, 150 million years old.
 - C Stone tool made by ancestors of humans, 2,6 million years ago.
 - D 195 million year-old dinosaur footprint in rock. (2)
- 1.9 The theory of evolution based on the principle of use and disuse was proposed by ...
- A Darwin.
 - B Mendel.
 - C Lamarck.
 - D Wallace. (2)

Question 2

Use the correct scientific terms when answering these questions.

- 2.1 The theory that better-adapted organisms are more likely to survive and become parents of the next generation.
- 2.2 Evolution that takes place below species level, in other words, a change in the genetic make-up of populations.
- 2.3 The ‘reptile-bird’ fossil that lived 150 million years ago, which Huxley used for the hypothesis that birds and reptiles were descended from common ancestors.
- 2.4 Remnants of more developed structures that were essential in ancestral organisms, such as the wings in ostriches.
- 2.5 The study of fossils.
- 2.6 A change in a population’s allele frequencies.
- 2.7 Haeckel’s theory that, during embryonic development, an organism will repeat the history of its species.
- 2.8 The chemical structural change in an organism’s DNA that results in changes within a population’s gene pool. (8)

Question 3

Match the terms from COLUMN B with a description in COLUMN A.

Column A	Column B
3.1 Structures that have evolved separately to perform a similar function.	A. Micro-evolution
3.2 Small scale changes that result from genetic adaptations within a species.	B. Punctuated equilibrium
3.3 Structures that appear different but have a similar evolutionary origin.	C. Sympatric
3.4 Evolution occurs in sudden bursts.	D. Gradualism
3.5 A structure that once had a purpose but is no longer useful to a particular organism.	E. Homologous
3.6 Speciation that occurs without a presence of barriers.	F. Vestigial
3.7 Evolution occurs at a fairly constant rate.	G. Analogous

(7)

Question 4

Study the following cladogram and answer the questions that follow.

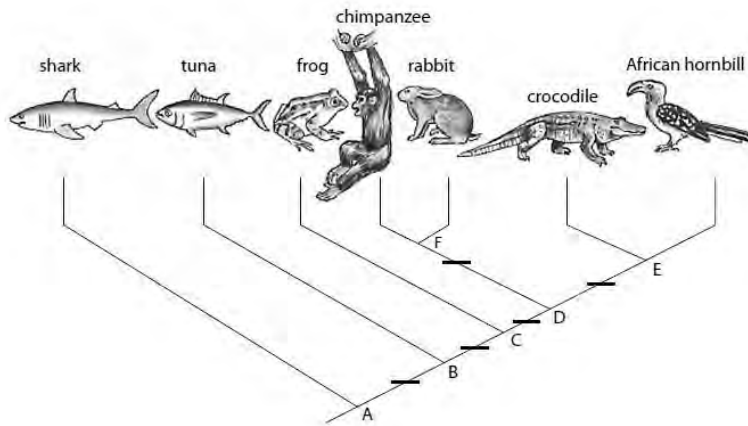

- 4.1 Indicate the correct letter that represents:
 - 4.1.1 The common ancestor of the tuna, frog, chimpanzee, rabbit, crocodile and African hornbill. (1)
 - 4.1.2 The common ancestor of the crocodile and African hornbill. (1)
- 4.2 What is meant by ‘vestigial organs’? Give TWO examples of such structures. (3)

Question 5

The result of a cross between a donkey and horse is a mule. Most mules are sterile.

- 5.1 What type of reproductive barrier does this represent? (1)
- 5.2 A horse has 64 chromosomes, and a donkey has 62 chromosomes. How many chromosomes will a:
 - 5.2.1 somatic mule cell have? (1)
 - 5.2.2 mule’s sperm or egg cell have? (1)
- 5.3 Name and briefly discuss FOUR lines of evidence for evolution. (8)
- 5.4 Use the concept of evolution to explain insecticide-resistant insects today. (5)
- 5.5 Design a demonstration to illustrate (on a lawn) how natural selection works, using dried white beans and coloured paint. What precautions will you take? (5)

Question 6

Giraffes feed on the leaves of trees, and are adapted, through evolution, to survive in their environment.

- 6.1 In which way is the giraffe adapted to its environment? (2)
- 6.2 Explain how Lamarck accounted for the evolution of the giraffe. (2)
- 6.3 Explain how Darwin accounted for the evolution of the giraffe. (2)
- 6.4 Explain the impact of Mendel’s laws of genetics on Lamarck’s hypothesis. (2)
- 6.5 What is meant by natural selection? (5)
- 6.6 What is the difference between natural selection and artificial selection? (2)

Question 7

In the 1950s Kettlewell did mark-recapture experiments with the Peppered Moth, *Biston betularia*. His results are given in the table below.

Recapture success	Light moth (%)	Dark moth (%)
Place A	14,6	4,7
Place B	13,0	27,5

- 7.1 Indicate whether the two places (A and B) are woods found in nonindustrial areas or industrial areas. Give a reason for your answer. (4)
- 7.2 Explain the role of natural selection in the above example. (2)

Question 8

Write an essay in which you critically reflect on the theory of evolution. In your essay you should look at evidence both for evolution and gaps in evolution theory. (20)

TOTAL MARKS: 100

Answers to Questions

Question 1

- | | | |
|-----|------|-----|
| 1.1 | C ✓✓ | (2) |
| 1.2 | B ✓✓ | (2) |
| 1.3 | B ✓✓ | (2) |
| 1.4 | C ✓✓ | (2) |
| 1.5 | A ✓✓ | (2) |
| 1.6 | D ✓✓ | (2) |
| 1.7 | B ✓✓ | (2) |
| 1.8 | C ✓✓ | (2) |
| 1.9 | C ✓✓ | (2) |

Question 2

- | | | |
|-----|----------------------------------|-----|
| 2.1 | Survival of the fittest | ✓ |
| 2.2 | Microevolution | ✓ |
| 2.3 | <i>Archaeopteryx</i> | ✓ |
| 2.4 | vestigial | ✓ |
| 2.5 | palaeontology | ✓ |
| 2.6 | mutation | ✓ |
| 2.7 | ontogeny recapitulates phylogeny | ✓ |
| 2.8 | mutation | ✓ |
| | | (8) |

Question 3

- | | | |
|-----|-----|-----|
| 3.1 | G ✓ | |
| 3.2 | A ✓ | |
| 3.3 | E ✓ | |
| 3.4 | B ✓ | |
| 3.5 | F ✓ | |
| 3.6 | C ✓ | |
| 3.7 | D ✓ | (7) |

Question 4

- 4.1.1 B ✓ (1)
- 4.1.2 E ✓ (1)
- 4.2 Structures that have no apparent modern use but were once used in ancestors ✓
 coccyx ✓ appendix ✓ little toe in humans ✓ wings in the ostrich ✓ (any 2)
 1+2=(3)

Question 5

- 5.1 Post-zygotic ✓ (1)
- 5.2.1 63 ✓ (1)
- 5.2.2 31 or 32 ✓ (1)
- 5.3 Anatomy ✓ – Homologous structures in common ✓
 Embryology ✓ – Developmental stages that show common features ✓
 Genetics ✓ – Common genes ✓
 Palaeontology ✓ – Fossil evidence ✓ (8)
- 5.4 Insects that survive insecticides live to produce offspring. ✓ Those that survive have enzyme systems that decrease the effect of the insecticide. ✓ These enzymes are produced by genes. ✓ The offspring will be able to produce the same enzymes, ✓ and, therefore give rise to a resistant population. ✓ (5)
- 5.5 **Method:**
 Take an even number of dried white beans. ✓
 Paint half of them green. ✓
 Scatter the beans on the grass randomly. ✓
 Observe and record after a while to see which are still present and have not been eaten. ✓ (any 3)
- Precautions:**
 Equal number of green and white beans ✓
 Random scattering ✓ 3+2=(5)

Question 6

- 6.1 Long neck ✓ to reach leaves in the trees. ✓ (2)
- 6.2 As the giraffes used their necks ✓ to reach for the leaves, so the necks would increase in length and the offspring would have longer necks. ✓ (2)
- 6.3 Giraffes with longer necks in the population survived by feeding off eaves to

- produce offspring with long necks. ✓ Those that had short necks were not able to feed and died without producing offspring over a period of time. ✓ (2)
- 6.4 Long and short neck genes may be alleles and are either present or absent in a population. ✓ They are not produced as a result of need but by mutation. ✓ Lamarck's hypothesis was thus refuted. ✓ (2)
- 6.5 Characteristics that are advantageous ✓ for survival are passed onto the next generation ✓ through survival of the fittest. ✓ Those that are unsuitable are not passed onto the next generation ✓ as the individuals that show them may not survive to reproduce. ✓ (5)
- 6.6 Natural selection occurs through the changes in an environment putting pressure on survival and change with those organisms that are suited to the change. ✓ Artificial selection occurs through breeding programmes where humans choose desired characteristics that they would like to see in the population. ✓ (2)

Question 7

- 7.1 Place A is woods in non-industrial areas ✓ as there are more light coloured moths indicating that the area is not polluted. The trees are not covered with dark sediment and the moths are camouflaged against the bark. ✓
Place B is woods in industrialised areas ✓ as the dark moth is found in high numbers. Pollution covers the trees with dark sediment and moths need a darker colour to survive. ✓ (4)
- 7.2 Those moths that are not camouflaged with the background are more visible and are eaten by predators. ✓ Those that are camouflaged, survive to breed. ✓ (2)

Question 8

Evaluating the theory of evolution

Introduction: Here you can reflect on evolution – is it a speculation, hypothesis, theory, model, law or principle? (Make sure that you know the difference between these constructs).

What does evolution say? Here you should unpack Darwin's theory of natural selection. In nature there is a struggle for survival. Organisms with favourable variations survive in greater numbers and reproduce. The next generation will have more individuals that have inherited the favourable characteristic. Over time, the characteristics of the population change as the favourable characteristics are preserved.

Evidence for evolution:

- *Anatomical evidence for evolution.* If all mammals developed from a common ancestor, they should have certain characteristics in common. If we look at the forelimbs of a number of mammals, we can see a striking resemblance. Many of the same skeletal elements make up the forelimbs of humans, cats, whales and bats. Although these appendages may have different functions (a whale's flipper is used for swimming, and a bat's wing for flying), they have similar characteristics, because they have the same ancestry. Similarity in characteristics because of common ancestry is known as homology. Many organisms have organs or structures that seem to be unnecessary, since they do not have a clear function. These are remnants (remainders) of more developed structures that were essential in ancestral organisms, and are called vestigial structures. An interesting example is the wings of an ostrich.
- *Embryonic evidence for evolution.* Haeckel's theory of 'ontogeny recapitulates phylogeny' states that, during embryonic development, an organism will repeat the history of its species in a shortened form. All vertebrate embryos have structures called pharyngeal pouches in their throat regions at some stage in their development. These embryonic structures develop into homologous structures with different functions. For instance, these structures develop into gills in fish, and into the Eustachian tubes that connect the middle ear with the throat in mammals.
- *Evidence from biogeography.* The geographic distribution of organisms also provides evidence for evolution. When Darwin studied the organisms on the Galapagos Islands, he realised that the organisms resemble the species on the mainland of South America, but they all developed into new species. Darwin realised that species tend to be more closely related to the species from the same area than to other species with the same life but living in different areas.
- *Molecular and biochemical evidence.* Similarities and differences in the biochemistry and molecular biology of various organisms provide evidence for evolution. Organisms owe the characteristics they have to their proteins (consisting of amino acids), and this is determined by the sequence of nucleotides in their DNA and mRNA. Evidence that all life is related comes from the fact that all organisms have a genetic code that is almost identical. Nucleotides occur in 3s (we call it a codon), and this is true of all life forms.
- *Evidence from the fossil record.* By studying fossils, palaeontologists can create images of what extinct organisms might have looked like, and make inferences about earlier common ancestors that species shared.

Problems in evolution theory:

- If a species is changed to another species gradually, with various steps, then many intermediate forms between these species should have existed. There should thus be plenty of fossil evidence for this. (In the case of the horse, the intermediate forms between *Equus*, the modern horse, and *Hyracotherium*, its earliest ancestor, are well preserved and explained. However, for some species, the current fossil records have not yet shown these intermediate forms.)
- The evolution theory tells us how small changes can be made, but a DNA change making the spontaneous creation of something as complicated as an eye is unlikely. (In fact, eyes have evolved gradually and independently several times in different lineages.)
- A major criticism of the evolution theory, is the creation of the first organism. If one looks at the complexity and size of a single cell, it seems improbable that this cell was created by chance. (Complex cells evolved from the amalgamation of simpler components.)

Marking rubric

Criteria	Marks			
	1	2	3	4
Thoroughness of content	Up to one third of potential detail cited.	About half of potential detail cited.	All main topics covered. About three quarters of potential detail cited. One instance of significant information beyond the sources.	All main topics covered. Source detail very close to full potential. At least two or more significant instances of information beyond the sources.
Relevant content	Mostly digression and/or repetition.	About half is digression and/or repetition.	Repetition mostly avoided. Some minor digression	Isolated incidences of minor repetition. No digression.
Supporting arguments for the position taken	Writing consists of facts with little linkage or reasoning. Reasoning incorrect.	No fixed position taken but rationally argues 'fors' and 'against's'. Reasoning correct but lengthy and hard to follow.	Supports the position. Reasoning is clear but a little lengthy. Minor errors in flow. Solid but not compelling;	Strongly supports a clear position. Reasoning is very clear and succinct. Flow is logical, showing evidence of clear planning (no afterthoughts).

TOPIC 6

Evolution by natural selection

		One paragraph placed illogically. Ordinary argument with some linkage evident.	linkage sometimes missed. No new information in conclusion.	Compelling, with regular use of linking language. No new information in conclusion. Refer to at least one incidence of bias, anecdote, false argument, emotive language, etc. where relevant.
Fairness of argument against the position taken	One counter-opinion given. Merit to counter-opinion not given.	Counter-opinions often given. One instance of merit to counter opinion given.	Counter-opinions regularly given. A few (two or more) instances of merit to counter-opinions given.	
Position	Clear decision made.			
Presentation	Writing is almost unintelligible. Language exceptionally weak. Inappropriate language.	Tone is inconsistent and/or in places inappropriate. Language is weak but appropriate. No terminology. Introduction and conclusion present, no matter how weak.	Tone is consistent and suited to scientific argument. Good and appropriate language. Some good use of terminology. Introduction and conclusion have merit. Some generalisations but not exaggerated.	Tone highly mature and suited to scientific argument. Excellent and appropriate language. Good use of terminology. Correct paragraphing with good transitions. Interesting introduction, satisfying conclusion. No sweeping generalisations.

(20)

TOTAL MARKS: 100

Overview

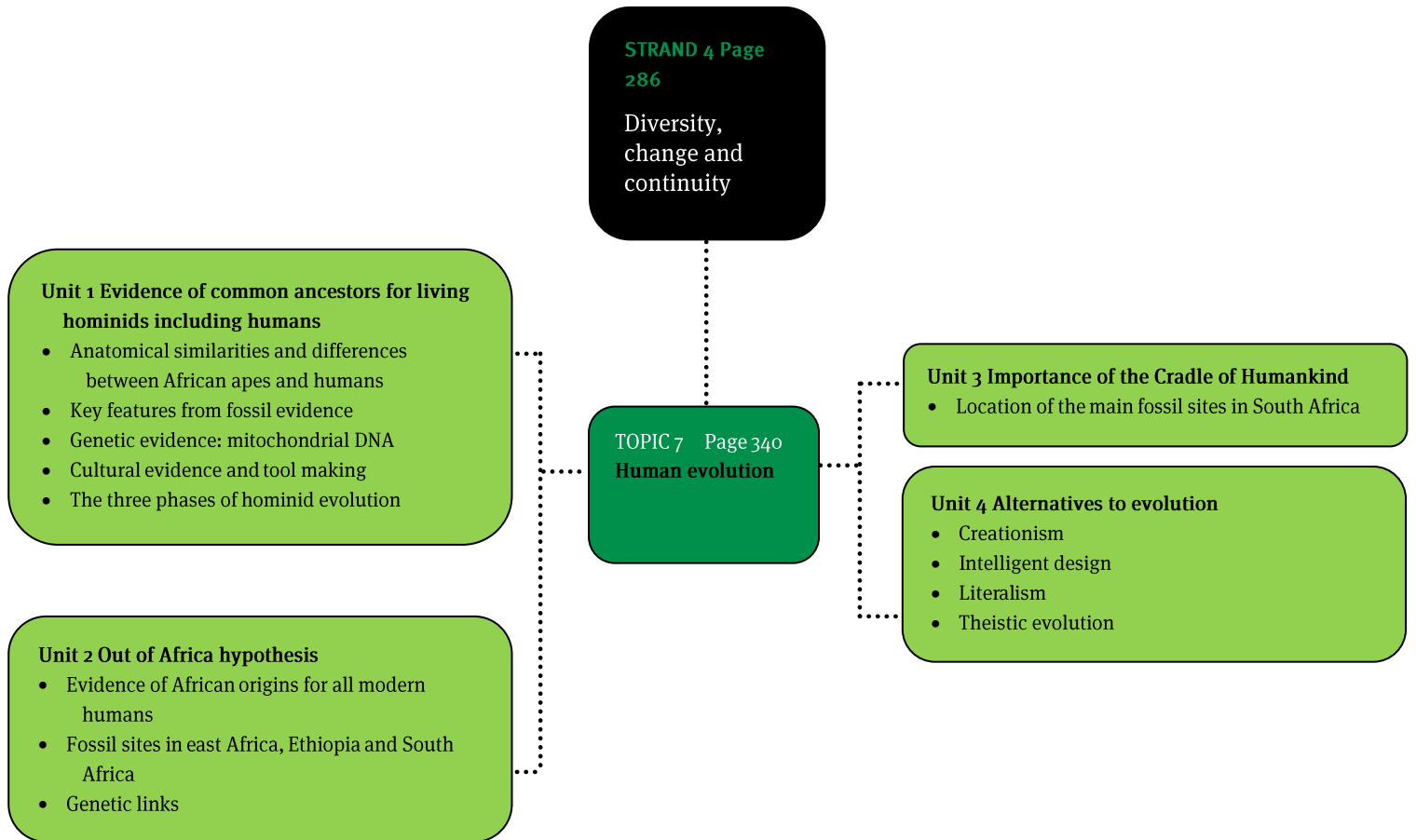

Units 1 to 4

1 Characteristics shared by the primates

- Primates are the apes and humans.
- The fossil primates and human-like forms, apes and humans are called hominids.

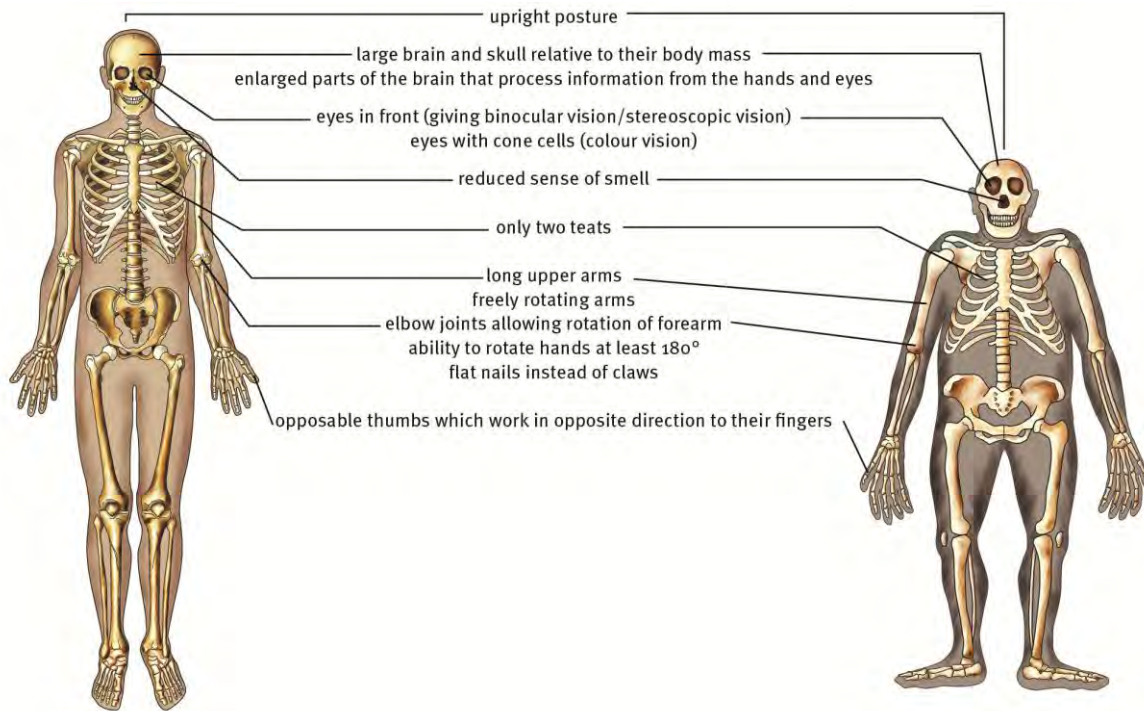

Figure 41 Similarities between humans and the African apes

2 Differences in facial characteristics

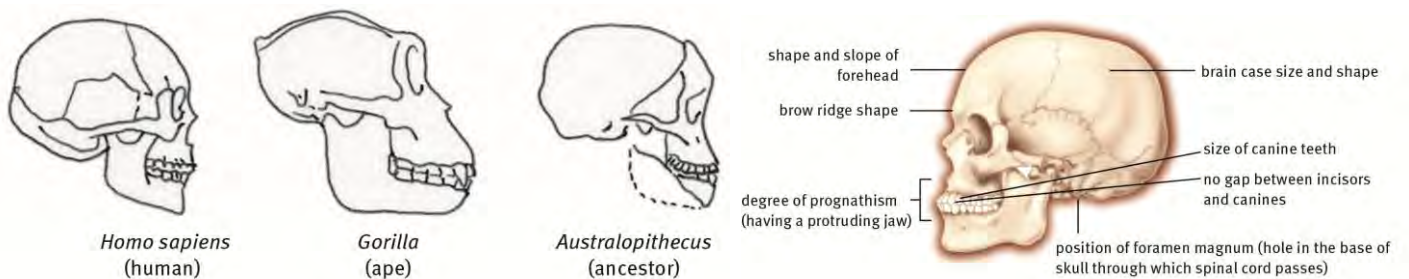

Figure 42 The difference between the facial features of humans and three related primates

3 Differences in general anatomy

Table 23 Comparison of different anatomical features between humans and African apes

Feature	African ape	Human
Canine size and position	Well developed and project outward from tooth row	Similar in size to other teeth and in-line with other teeth
Spaces between teeth	Larger spaces between the teeth	Smaller or no spaces between the teeth
Jaws	Jaws with teeth in a rectangular / U shape; protruding jaws (prognathus)	Jaws with teeth on a gentle / round curve; less protruding jaw, not prognathus
Tooth enamel	Thin layer of enamel	Thick layer of enamel
Cranial capacity	Smaller cranium	Proportionally larger cranium
Foramen magnum	Opens in the posterior of the skull	Opens at the base of the skull
Brow ridges	Heavily pronounced brow-ridge	Brow-ridge less pronounced
Cheekbones	Large cheekbone	Proportionally shorter cheekbone
Tibia	Thin and angled	Less angled
Rib cage	Broad and extends past vertebral column	Broad and extends past vertebral column
Scapula	On the back with the shoulder joints orientated to the sides	On the back with the shoulder joints orientated to the sides
Pelvis	Narrow pelvis	Wider pelvis
Foot	Big toe is apart from the other toes and opposable; heel bone is relatively smaller	Big toe is close to other four smaller toes and faces forward; heel bone is relatively larger
Chin	Lower jaw has well developed chin	Jaw has poorly developed chin

4 Key features from fossil evidence

- Palaeontologists research and study hominid fossil evidence.
- Some key features that are used to compare hominid fossils are:
 - Bipedalism (spine and pelvic girdle) – Apes walk on all four limbs. Humans walk on two limbs (feet) only.
 - Pelvic girdle – In apes, the pelvis is elongated and narrow. In humans, the pelvic girdle is wide and flattened into a shallow bowl shape for walking upright.
 - Spine – The spine of the apes leans forward in order to facilitate four-limb walking. The spine of the human is vertical and sigmoid (S-shaped) to allow the pelvis, legs and feet to be directly under the abdomen, allowing for bipedalism.
 - Foramen magnum – In apes, the foramen magnum is situated to the back of the skull and opens backwards and downwards. In humans, the foramen magnum is at the base of the skull and opens directly downwards.
 - Brain size – Cranium in apes is about 400 cm³. In humans it is about 1 300 cm³.

- Dentition – Apes have larger jaws, larger molars and canines. Humans jaws are parabolic and have smaller molars and canines.
- Prognathism – Apes faces project forward. Humans’ faces are flattened.
- Palate shape – Apes have rectangular palates. Humans palates are parabolic.
- Cranial and brow ridges – Apes have obvious crests and ridges on their skulls: sagittal crests and the brow ridges. Humans are less defined.

5 Genetic evidence: Mitochondrial and Y chromosomal DNA

- Y chromosomal DNA is used to trace male ancestry.
- Mitochondrial DNA (mtDNA) is used to trace female ancestry.
- Humans are thought to be descended from a common type of female called the ‘African eve’.

6 Cultural evidence and tool making

- Humans first made tools of stone at least 2,5 million years ago, initiating the so-called Stone Age.
- The use of tools improved nutrition and lead to changes in social behaviour.
- *Homo habilis* shows the first use of tools.

7 The three phases of hominid evolution

Phase	Species	Time period
1 <i>Ardipithicus</i>	<i>Ardipithicus ramidus</i>	5 to 4 million years ago
2 <i>Australopithecus</i>	<i>Australopithecus anamensis</i>	4,2 to 3,9 million years ago
	<i>Australopithecus afarensis</i>	4 to 2,7 million years ago
	<i>Australopithecus africanus</i>	3 to 2 million years ago
	<i>Australopithecus robustus</i>	2,2 to 1,6 million years ago
3 <i>Homo</i>	<i>Homo habilis</i>	2,2 to 1,6 million years ago
	<i>Homo erectus</i>	2,0 to 0,4 million years ago
	<i>Homo sapiens archaic</i>	400 to 200 thousand years ago
	<i>Homo sapiens neandertalensis</i>	200 to 30 thousand years ago
	<i>Homo sapiens sapiens</i>	200 thousand years ago to present

8 The ‘Out of Africa’ hypothesis

- The ‘Out of Africa’ hypothesis states that every human being is descended from a small group of individuals in Africa.

- After *Homo erectus* migrated out of Africa the different populations became isolated and could not interbreed.
- This allowed these populations to adapt independently.
- East Africa seems to be most likely place for the origin of human ancestors because genetic evidence shows that all humans outside Africa share groups of genes with people from east Africa.
- The evidence for the first ancient humans, the earliest members of the genus *Homo*, come from fossils discovered in east Africa between 1,9 and 2,4 million years ago.
- The origin of *Homo sapiens* occurred in one place.

Scientist	Fossil	Place of discovery	Year of discovery, age	Picture	Characteristic
Michel Brunet and team mates	Toumai <i>Sahelanthropus tchadensis</i>	Chad	2001 6–7 million years old		Forward position of foramen magnum suggests bipedalism
Raymond Dart	Taung child <i>Australopithecus africanus</i>	Taung, Northern Cape, South Africa	1924 2,6–2,8 million years old		Forward position of f.m. – bipedal Dentition of a human baby, rounded head Less sloping forehead
Robert Broom	Mrs Ples <i>Australopithecus africanus</i>	Sterkfontein caves, South Africa	1947 2,6 million years old		Forward position of f.m. – bipedal Dentition of a human, rounded head Less sloping forehead
Mary and Louis Leakey	Handy man <i>Homo habilis</i>	Olduvai Gorge in Tanzania	1960 2,5 million years old		Less pronounced brow-ridges, more human-like teeth, flatter face, more rounded head and a brain size of 650–800 cm ³
Mary Leakey	Laetoli footprints 12	Laetoli in Tanzania	1978 3,6 million years ago		Bipedal animal
Lee Berger and Brett Eloff	Karabo <i>Australopithecus sediba</i>	Caves near Malapa in the Cradle of Humankind, South Africa	2008 1,95 million years ago		Characteristics of both primitive ape-like species and later humans
Donald Johanson, Yves Coppan and Tim White	Lucy <i>Australopithecus afarensis</i>	Ethiopia	1974 3,2 million years old		Forward position of foramen magnum suggests bipedalism
TF Dreyer	Florisbad Man <i>Homo sapiens</i>	Free State, South Africa	1932 250 000 years old		Rounded head
Ronald Clarke	Little Foot	Sterkfontein Caves, South Africa	1994		Moved both on ground and through trees, i.e. showed ape and human characteristics

Figure 43 Fossil evidence in support of the Out of Africa hypothesis

9 Migration of *Homo sapiens* from Africa into the rest of the world

- There are three broad, and complex pathways or migratory patterns:-
 - One group travelled along the coast of Arabia, India, south-east Asia until they reached Australia.
 - Another group went through Arabia and migrated to Western Europe.
 - The third group went through Arabia and gave rise to branches which led to human populations in northern Europe, central Asia, India, China and North and South America.

10 Genetic links

- Individuals who have the same mutation in their DNA must share the same common ancestor.
- These mutations serve as markers of descent.
- Results from mitochondrial DNA as well as Y-chromosome DNA studies serve as evidence for the Out of Africa hypothesis.
- These two parts of the genome are not shuffled during crossing over and recombination with each generation.
- They are both are passed down to the next generation in the same form.
- **Mitochondrial Eve** – According to this hypothesis, all people alive today have inherited the same mitochondria from a woman who lived in Africa about 160 000 years ago, who we call ‘Mitochondrial Eve’. mtDNA comes from women through the ovum during sexual reproduction.
- **Y chromosome Adam** – All men living today have inherited their Y chromosomes from a man who lived about 140 000 years ago, probably in Africa. He has been named ‘Y-chromosomal Adam’. Y chromosomal DNA comes from the male during sexual reproduction.

11 Methods used to find the age of fossils

- **Relative dating** – The age of the fossil is worked out by trying to find out how it is related to the age of another fossil, or geological event such as a volcanic eruption.
- **Radiometric dating** – Radiometric dating gives a more accurate age to a fossil. Radioactive isotopes of certain mineral elements are used. Scientists measure the amount of radioactive isotopes either in the fossil or, more commonly, the rock in which the fossils are buried. The scientists calculate the ratio between the original amount of radioactive isotopes present and the amount now remaining. They can then work out how long ago the fossil died or how long ago that rock layer was laid down.

12 Alternative explanations to evolution

- **Creationism** – Creationists base their ideas on the following points:
 - All living forms have been created by a Supreme Being.
 - The organisms have not changed since their creation.
 - Different forms of life were designed to function in particular settings, they have not adapted to them.
- **Intelligent design (ID)** – This explanation is based on the following ideas:
 - Cells are too highly organised to have developed on their own from molecules which themselves were the result of chance combinations.
 - The differences between different organisms are too complex for them to have evolved from a common ancestor.
 - Therefore, the diversity of life could have only come about because each one has been cleverly (intelligently) designed.
 - Those who believe in ID prefer not to be called creationists because they believe their evidence is purely scientific and not faith-based.
- **Literalism** – Literalists believe that the Bible or Koran, or other religious book, must be taken as literally true and that it is not possible that there are errors in those books.
- **Theistic evolution** – Theistic evolution is the idea that classical religious teachings about God are compatible with the scientific theory of evolution. Theistic evolutionists believe that there is a God, that God is the creator of the universe and all life, and that evolution is a process within the natural universe.

Questions

Question 1

Various answers are provided to each question. Choose the correct answer. Only write the letter of the answer you select next to the question number.

- 1.1 The table below shows the number of differences in the amino acids sequence of the protein albumin in four species of primates.

Species of primates	Monkey	Gibbon	Gorilla	Human
Human	32	14	8	0
Gorilla	32	14	0	
Gibbon	32	0		
Monkey	0			

Which two species are likely to have separated most recently according to the results on the table?

- A Humans and monkeys
 B Gorillas and gibbons
 C Gibbons and Monkeys
 D Gorillas and humans (2)
- 1.2 The characteristic that humans DO NOT share with other primates is ...
 A opposable thumb.
 B freely rotating arms.
 C bare finger tips.
 D a flat face. (2)
- 1.3 Which of the following features (i) to (v) below describe African apes?
 i wide pelvis
 ii heavily pronounced brow ridges
 iii small jaw with no spaces between the teeth
 iv large, protruding canines
 v small cranium
 A (i), (ii) and (iii)
 B (ii), (iii) and (iv)
 C (iii), (iv) and (v)
 D (ii), (iv) and (v) (2)

- 1.4 The Taung child was discovered by ...
- A Robert Broom
 - B Raymond Dart
 - C Mary Leakey
 - D Ronald Clarke
- (2)

Question 2

Give the correct scientific terms for each of the following statements.

- 2.1 The study of ancient human-like forms.
 - 2.2 A limb with five digits.
 - 2.3 An absolute dating mechanism of rocks.
 - 2.4 A diagram that shows possible evolutionary relationships between groups of organisms.
 - 2.5 Walking on two legs.
 - 2.6 A possible explanation to a problem being investigated.
 - 2.7 Remainder of a body structure inherited but totally unused and inconspicuous.
 - 2.8 Large hole at the base of the skull.
 - 2.9 Forward projection of the lower portion of the face.
 - 2.10 Explanation that every human being is descended from a small group of individuals in Africa.
- (10)

Question 3

Match the terms from COLUMN A with those in COLUMN B.

Column A	Column B
3.1 Handy man	A. <i>Sahelanthropus tchadensis</i>
3.2 Taung child	B. <i>Australopithecus afarensis</i>
3.3 Lucy	C. <i>Homo sapiens</i>
3.4 Florisbad Man	D. <i>Australopithecus sediba</i>
3.5 Toumai	E. <i>Homo habilis</i>
3.6 Karabo	F. <i>Australopithecus africanus</i>

(6)

Question 4

The diagram below shows the skull and pelvis of three mammals. Study the diagram and answer the questions that follow.

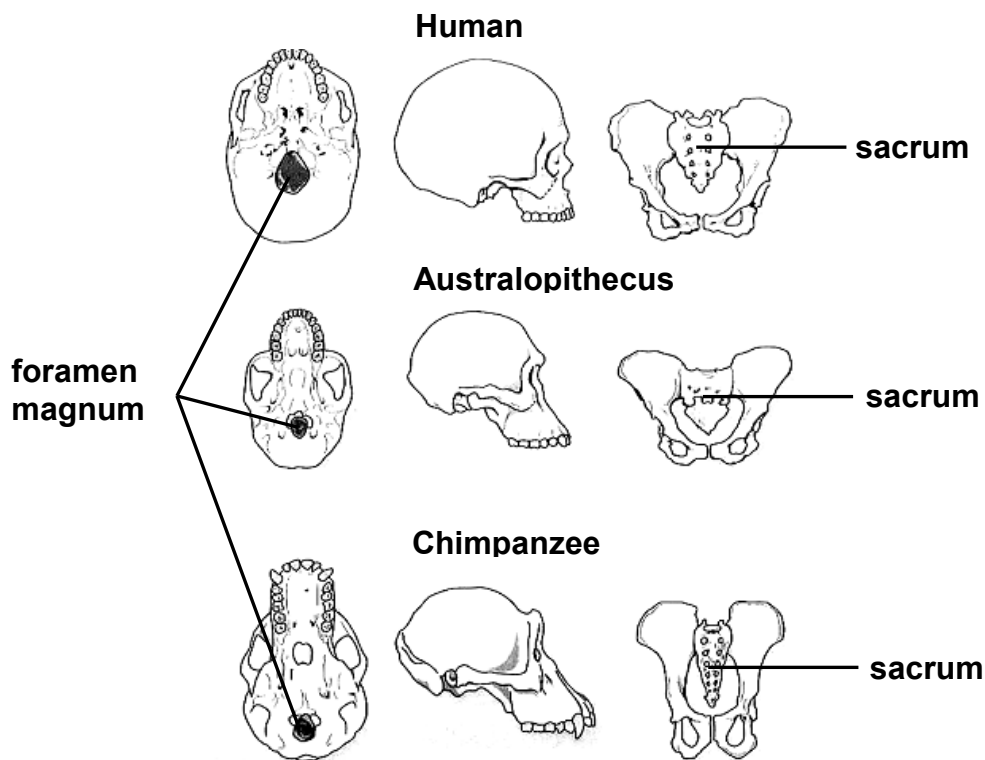

Skull and pelvis of a human, *Australopithecus* and chimpanzee

- 4.1 Tabulate FOUR observable differences of the skull and pelvis of a human and chimpanzee. (5)
- 4.2 Which organism(s) is/are bipedal? (2)
- 4.3 Give ONE reason, observed from the diagram, for your answer to QUESTION 4.2. (2)
- 4.4 State ONE visible difference between the skull of *Australopithecus* and the human. (1)

Question 5

During the study of the fossil records the following timeline of hominids were constructed. Study it and answer the questions that follow.

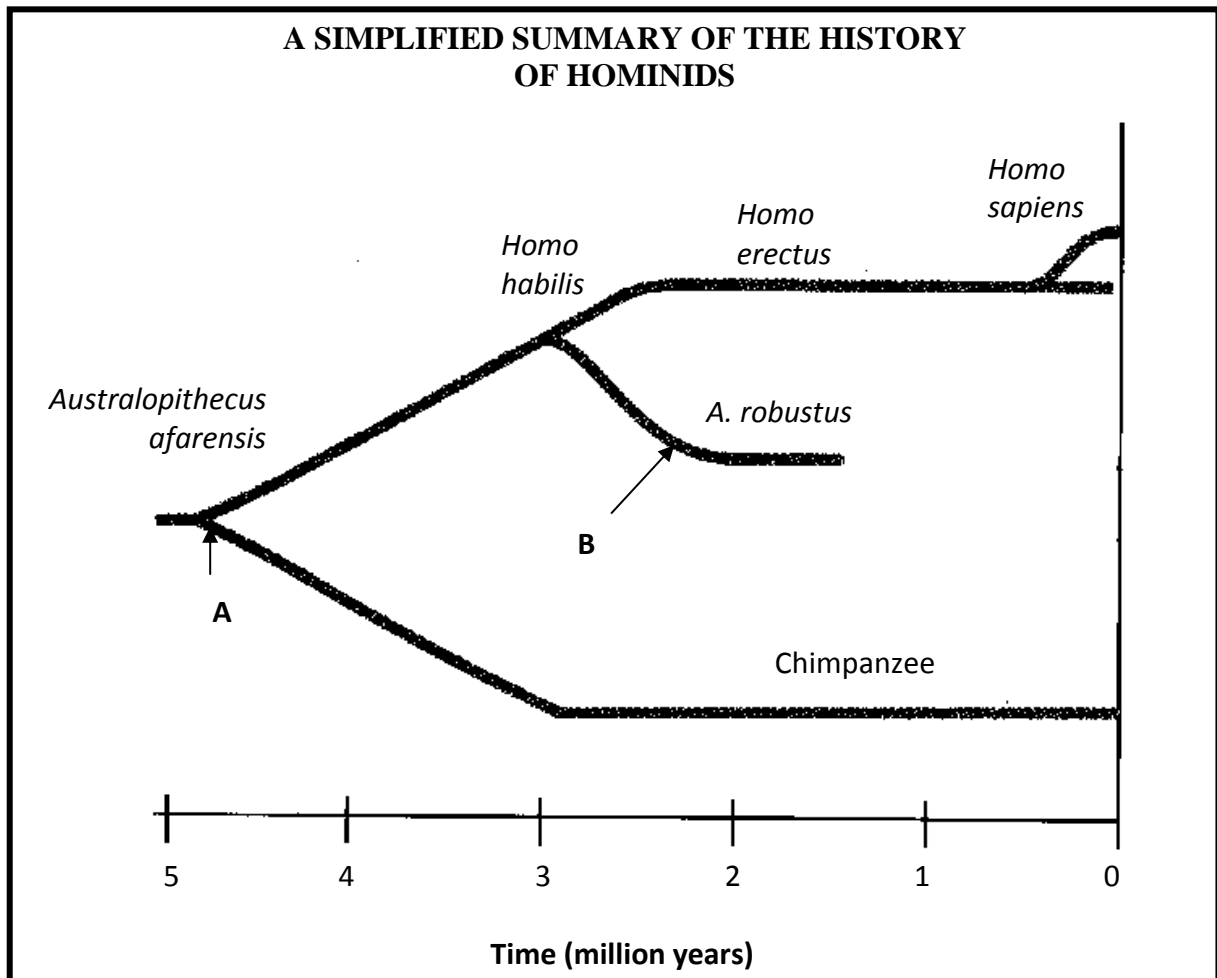

- 5.1 How many million years ago did the hominid group split (at A) into two groups? (1)
- 5.2 What is the main characteristic that caused the hominids to split into two separate groups at A? (1)
- 5.3 Which organism is thought to be the immediate ancestor of *A. robustus*? (1)
- 5.4 What are the common names of TWO *Australopithecus* species fossils that were discovered in South Africa? (2)
- 5.5 List FOUR characteristics that primates and humans have in common. (4)
- 5.6 Name TWO fields of study, other than embryology and biochemistry, that scientists may have used to propose the evolutionary relationships shown in the diagram. (2)

- 5.7 Explain why we cannot be sure that the evolutionary relationships displayed in the diagram are absolutely correct. (2)

Question 6

In an investigation a biotechnologist injected chimpanzee blood into a rabbit. The immune system of the rabbit recognised the chimpanzee blood protein as a foreign and produced antibodies. The rabbits antibodies were then extracted and developed as a serum. When the serum is added to blood samples in different test tubes removed from a variety of different animals, a precipitate forms. The more precipitate forms, the more closely the animal is related to the chimpanzee. Study the table below that shows the percentage precipitate formed in this investigation, and answer the questions that follow.

Animal species	Percentage precipitate formed
Gorilla	Very high
Baboon	High
Monkey	Moderate
Pig	Very low

- 6.1 What is the composition of the serum? (2)
- 6.2 According to the above information, which animal is the least closely related to chimpanzees? Give a reason for your answer. (2)
- 6.3 Formulate a hypothesis for the investigations above. (2)
- 6.4 Name TWO variables that had to be kept constant in this investigation. (2)

Question 7

Describe the anatomical similarities and facial differences between African apes and humans that are used as evidence of common ancestors between living hominids. (20)

TOTAL MARKS: 65

Answers to Questions

Question 1

Various answers are provided to each question. Choose the correct answer. Only write the letter of the answer you select next to the question number.

- 1.1 D ✓✓ (2)
- 1.2 D ✓✓ (2)
- 1.3 D ✓✓ (2)
- 1.4 B ✓✓ (2)

Question 2

- 2.1 palaentology ✓
- 2.2 pentadactyl ✓
- 2.3 radiometric ✓
- 2.4 phylogenetic tree ✓
- 2.5 bipedal ✓
- 2.6 hypothesis ✓
- 2.7 vestigial ✓
- 2.8 foramen magnum ✓
- 2.9 prognathism ✓
- 2.10 Out of Africa ✓ (10)

Question 3

- 3.1 E ✓
- 3.2 F ✓
- 3.3 B ✓
- 3.4 C ✓
- 3.5 A ✓
- 3.6 D ✓ (6)

Question 4

4.1 Differences between the skull and pelvis of a human and chimpanzee

	Human	Chimpanzee
skull	Small brow ridges✓	Large brow ridges✓
	Flat face✓	Extended / prognathial face✓
	Parabolic palate✓	Rectangular palate✓
	Foramen magnum in centre of skull✓	Foramen magnum at back of skull✓
pelvis	Shallow, broad pelvis✓	Elongated pelvis✓
	Sacrum wide✓	Sacrum narrow✓

(2 pairs for skull and 2 pairs for pelvis) (4)

(1 for table and heading) (1)

4.2 *Australopithecus* ✓ and human ✓ (2)

4.3 The pelvic girdle is wide and flattened into a shallow bowl shape ✓ to hold the weight of the upper body during walking. ✓ (2)

4.4 Cranium volume of *Australopithecus* is smaller than the human. Face protrudes more than the human. ✓ (1)

Question 5

5.1 4,6–4,8 million years ago ✓ (1)

5.2 bipedalism ✓ (1)

5.3 *Australopithecus afarensis* ✓ (1)

5.4 Little foot

Mrs Ples

Taung child

(any 2) (2)

5.5 Bare finger tips ✓

Long arms ✓

Freely rotating arms ✓

Stereoscopic vision ✓

Eyes with cones (in addition to rods) ✓

Large brain compared to body mass ✓

Portions of brain centres that process information from hands and eyes enlarged ✓

Olfactory brain centres ✓

Few offspring ✓

(any 4) (4)

- 5.6 Anatomy ✓
 Genetics ✓
 Biogeography ✓
 Palaeontology ✓ (any 2) (2)
- 5.7 Fossils are incomplete. ✓
 Few numbers collected. ✓
 They were found in different locations around the world. ✓ (any 2) (2)

Question 6

- 6.1 The serum contains antibodies ✓ against chimpanzee protein. ✓ (2)
- 6.2 Pig ✓ It only forms a very low % ✓ precipitate when the blood is exposed to serum. (2)
- 6.3 A high percentage ✓ of precipitate formed indicates a close relationship ✓ with chimpanzees. (2)
 OR
 A low percentage ✓ of precipitate formed indicates distant ✓ relationship with chimpanzees. (2)
 OR
 A high percentage ✓ of precipitate formed indicates a weak ✓ relationship with chimpanzees. (2)
 OR
 A low percentage ✓ of precipitate formed indicates a strong ✓ relationship with chimpanzees. (2)
- 6.4 temperature, ✓ pH, ✓ concentration of serum. ✓ amount of serum and blood the same ✓ (any 2) (2)

Question 7

Anatomical similarities:

Humans and apes show the following anatomical similarities:

- Bare finger tips ✓
- Flat nails instead of claws ✓
- Opposable thumbs which work in opposite direction to their fingers ✓
- Long arms ✓
- Freely rotating arms ✓

- Elbow joints allowing rotation of forearm ✓
- Ability to rotate hands at least 180° ✓
- Eyes in front (giving binocular / stereoscopic vision) ✓
- Colour vision / eyes with cones (in addition to rods) ✓
- Upright posture ✓
- Large brain and skull relative to their body mass ✓
- Brain centres that process information from hands and eyes enlarged ✓
- Reduced smell / olfactory brain centres ✓
- Two teats ✓ (10 max) (10)

Facial differences:

Human	African apes
Small brow ridges ✓	Large brow ridges ✓
Flat face ✓	Extended / prognathus face ✓
Parabolic palate ✓	Rectangular palate ✓
Small canines ✓	Large, protruding canines ✓
Smooth, curved jaws ✓	Rectangular jaws ✓
Short cheek bones ✓	Large cheek bones ✓
Well developed chin ✓	Poorly developed chin ✓

(5 pairs) (10)

TOTAL MARKS: 65

Overview

This is a revision topic (of Strand 3 Environmental studies) and you should work through your Grade 11 notes to prepare for the final examination. In this topic you will revise the following from Grade 11.

- The atmosphere and climate change
 - carbon dioxide emissions and reducing our carbon footprint
 - methane emissions
 - deforestation
 - the greenhouse effect and global warming
- Water availability
 - dams, loss of wetlands and poor farming practices
 - droughts and floods
 - exotic plantations and depletion of the water table
 - boreholes and their effects on aquifers
 - how water is wasted
 - water quality and pollution in domestic, industrial, agricultural and mining supplies
 - diseases, eutrophication and algal bloom
 - thermal pollution
 - water purification and recycling
 - alien plants
- Food security
 - human exponential population growth
 - droughts and floods due to climate change
 - poor farming practices and effects of alien plants
 - loss of wild varieties and impact on the gene pool
 - genetically-engineered food and wastage of food
 - Loss of biodiversity – the sixth extinction
 - habitat destruction, poaching and alien plant invasion
 - indigenous knowledge systems and sustainability
- Solid waste disposal
 - recycling and managing and rehabilitating dumpsites
 - using dumpsite methane
 - disposing of nuclear waste.

1 The atmosphere and climate change

- Human actions have increased greenhouse gases (GHGs).
- There are two main ways this happens:
 - humans burn fossil fuels that increase CO₂ levels
 - humans deforestation (grow and slash) which decreases the uptake of CO₂ by trees for photosynthesis
 - human deforestation through slash and burn increases the levels of CO₂ in the atmosphere.
- Methane gas (CH₄) emissions are part of global warming.
- Human activities that are sources of methane emissions include:
 - combustion of oil and natural gas
 - coal mining
 - sewage
 - decomposing refuse in landfills
 - deforestation
 - agriculture – animals and waste.
- The ozone layer shields life on Earth from the damaging effects of ultra violet (UV) radiation from the Sun. CFCs destroy ozone.

2 Water availability

- A number of factors influence water supply:
 - semi-arid areas with low, erratic rainfall
 - high-runoff regions far from areas of demand
 - limited and often poor quality groundwater in aquifers the main source of supply in rural areas
 - catchments areas full of alien vegetation which use more water than natural vegetation
 - limited water supply of a suitable quality.
- Destruction of wetlands by agricultural land and dam building destabilises the environment and removed biodiversity. Wetlands are also natural filters of polluted water.
- Poor farming practices abuse water sources resulting in drought, desertification, flooding through run-off arising from erosion.
- Exotic plants use more water than indigenous plants drying up the water table.
- Mining and industry uses excessive quantities of water with limited recycling.
- Domestic waste of water abuses and reduces water availability. Water is overheated in industry that decreases its biotic diversity and quality.

3 Food security

- There are seven aspects that contribute to food insecurity:
 - climate change and food security: droughts and floods
 - human population explosion and food security
 - harmful farming practices
 - invasive alien plants
 - loss of wild plant varieties
 - genetically modified organisms
 - wastage.

4 Loss of biodiversity – the sixth extinction

- The causes of loss of biodiversity are:
 - **Habitat destruction** – farming methods, increased human population and building of towns, golf estates, pollution, deforestation, soil erosion, fires, global warming, limiting migration patterns.
 - **Poaching** – rhino horn, elephant ivory, gorillas and chimpanzees, bush meat, hides and abalone, removal of indigenous endangered plants.
 - **Alien plant invasion** – invasive growth, use more water, removal of indigenous animal populations that are not adapted to the alien vegetation.
 - **Limited use and abuse of indigenous knowledge** – Abuse of limited sources, or lack of scientifically tested and confirmed knowledge and remedies or medicinal value of indigenous plants.

5 Solid waste disposal

- Most solid waste ends up in dumpsites: open dump sites and landfills.
- Solid waste affects water systems and biodiversity.
- Solid waste is also a health hazard.
- Nuclear waste arising from nuclear power plants is stored underground or under water.

Questions

Question 1

Various answers are provided to each question. Choose the correct answer. Only write the letter of the answer you select next to the question number.

- 1.1 The main cause of the increase in the amount of CO₂ in the Earth's atmosphere is ...
- A increased worldwide primary production.
 - B increased worldwide standing crop biomass.
 - C an increase in the amount of infrared radiation.
 - D the burning of large amounts of wood and fossil fuels. (2)
- 1.2 A natural population of plants can be regarded as sustainable if ...
- A the community members can collect enough to feed their families.
 - B the community members are able to sell whatever they collect.
 - C the plant population recovers so that plants can be harvested in the future again.
 - D it does not harm the tourist potential of the area. (2)
- 1.3 The use of natural enemies to control the spread of alien vegetation is ...
- A biological control.
 - B mechanical control.
 - C chemical control.
 - D all of the above. (2)
- 1.4 Which of the following air pollutants are known to cause acid deposition (acid rain)?
- A methane
 - B sulphur dioxide
 - C carbon dioxide
 - D CFCs (2)
- 1.5 Ozone destruction is caused by ...
- A CFCs.
 - B methane.
 - C carbon dioxide.
 - D carbon monoxide. (2)

- 1.6 Smog is formed from ...
 A smoke and fog.
 B mist and wind.
 C smoke and sand.
 D wind and sand. (2)
- 1.7 The pollutants that exit from exhaust pipes of cars are ...
 A water vapour and sulphur dioxide.
 B methane and carbon dioxide.
 C lead oxide and carbon monoxide.
 D persistent organic pollutants. (2)
- 1.8 Which disease can be caused by air pollution?
 A ulcers
 B asthma
 C measles
 C thrush (2)
- 1.9 Breathing in excess carbon monoxide causes ...
 A muscle cramps.
 B a deteriorated nervous system.
 C rashes.
 D headaches and dizziness. (2)
- 1.10 Organisms that indicate sewage polluted water bodies are ...
 A fungi.
 B fish.
 C. coliforms.
 D ferns. (2)
- 1.11 Which of the following processes are involved in eutrophication of water bodies?
 A leaching
 B run-off
 C precipitation
 D all of the above (2)
- 1.12 Which of the following organisms are good indicators of clean water bodies?
 A mayfly and stonefly nymphs
 B blue-green algae and sludge worms
 C water snails and sludge worms

- D water hyacinth and blue-green algae (2)
- 1.13 Which of the following substances are carcinogenic (cancer-causing) pollutants?
- A carbon dioxide
- B methane
- C radioactive substances
- D bio-plastics (2)
- (26)

Question 2

Use the correct scientific terms when answering these questions.

- 2.1 The chemical compound that breaks down the ozone layer in the atmosphere. (1)
- 2.2 The collection of gases found below the stratosphere. (1)
- 2.3 Form of pollution that occurs when sulphur dioxide emissions react with water in the atmosphere. (1)
- 2.4 The legal killing of animals to keep their populations in balance. (1)
- 2.5 Human industrial activities like fishing and farming. (1)
- 2.6 The gases that cause the hole in the ozone layer. (1)
- 2.7 The effect that arises when greenhouse gases prevent the loss of radiation from Earth into the atmosphere. (1)
- 2.8 The continued removal of plants and trees. (1)
- 2.9 The ongoing confined grazing of pasture. (1)
- 2.10 The increase in concentration of a poison within consecutive levels of a food chain. (1)
- 2.11 A most common Persistent Organic Pollutant found in water bodies that is banned in most parts of the world. (1)
- 2.12 The illegal capture or killing of endemic animals for body parts. (1)
- 2.13 South African plants and animals. (1)
- (13)

Question 3

Several statements are provided below. Decide if each statement is scientifically correct. Write the words 'True' or 'False' next to each question number to indicate your decision.

- 3.1 The atmosphere contains oxygen gas, water vapour, carbon dioxide gas. (1)
- 3.2 Acid rain forms when hydrogen sulphide gas and sulphur dioxide reacts with water in the atmosphere. (1)

TOPIC 8**Human impact on the environment: Revision**

- 3.3 Culling is growing indigenous plants. (1)
- 3.4 Secondary human industrial activities are fishing and farming. (1)
- 3.5 Chlorofluorocarbons (CFC's) are responsible for the hole in the ozone layer. (1)
- 3.6 Global warming occurs when carbon dioxide and other greenhouse gases prevent the loss of radiation from Earth into the atmosphere. (1)
- 3.7 The carbon dioxide and oxygen balance is upset by deforestation. (1)
- 3.8 Overgrazing causes deforestation. (1)
- 3.9 The increase in numbers of organisms in a food chain is known as bioamplification. (1)
- 3.10 DDT is a Chlorofluorocarbon (CFC). (1)
- 3.11 Poaching is the illegal capture or killing of endemic animals for animal parts. (1)
- 3.12 'Rooibos' (red bush) tea is an indigenous plant. (1)
- (12)

Question 4

Match the phrases in Column 1 with the scientific terms in Column 2. Provide only the letter of the corresponding word next to each question number.

COLUMN 1		COLUMN 2	
4.1	Global warming	A	Thermocline
4.2	Bioamplification	B	Muti
4.3	Lack of oxygen in water bodies	C	Protea
4.4	Exotic plant	D	Deforestation
4.5	Indigenous plant	E	CFCs
4.6	Poaching	F	Acid rain
4.7	Illegal use of body parts	G	Eutrophication
4.8	Damage to stone buildings	H	Food
4.9	Removal of vegetation	I	Ivory
4.10	Increased erosion	J	DDT
		K	Water hyacinth
		L	Desertification

(10)

Question 5

The table below shows the amount of solid waste generated in a town over a period of 6 years. Study the table below and answer the questions that follow.

YEAR	TOTAL SOLID WASTE (tonnes)
1999	255
2000	276
2001	300
2002	330
2003	388
2004	428

- 5.1 Draw a bar graph to represent the data in the table in the graph above. (8)
 - 5.2 What general trend is indicated by the graph you have drawn? (1)
 - 5.3 In which year was the solid waste generated the highest? (1)
 - 5.4 What is the difference in the amount of waste generated between 2001 and 2003? Show ALL the calculations. (2)
 - 5.5 Name TWO main sources of the town’s solid waste. (2)
 - 5.6 What strategies could the municipality employ to manage the increase in municipal solid waste? Name TWO strategies and their impact on the environment. (4)
- (18)

Question 6

The graph below shows reported cases of waterborne diseases affecting children living in the rural areas in a province in a year. Study the graph and answer the questions that follow.

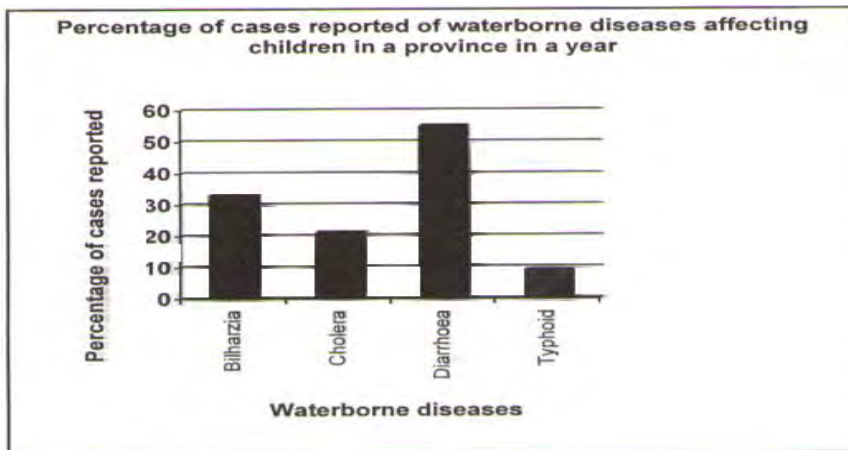

- 6.1 Name TWO main sources of water pollution. (2)
 - 6.2 According to the graph, which disease had the highest percentage of cases reported in the province? (1)
 - 6.3 Describe FOUR possible ways in which data was collected for this investigation. (4)
 - 6.4 Explain TWO ways in which rural communities can protect themselves from the disease mentioned in QUESTION 5.2. (2)
 - 6.5 Describe TWO strategies the provincial government can use in the management and control of water pollution. (2)
- (11)

Question 7

Read the following information and answer the questions that follow.

Perlemoen issues

Abalone, or perlemoen as it is known in South Africa, is a large sea snail that feeds on kelp (seaweed). It is known for its shiny inside – mother of pearl. Perlemoen is regarded as a delicacy in the East. According to regulations, perlemoen may be removed by divers once the shell has reached a diameter of 115 mm. By this time the animal is 8 years old. Divers may remove four perlemoen per day during the diving season. Poachers unfortunately do not heed any of the regulations and as a result this natural resource is being removed at an alarming rate. Interest in this organism has led to two effects. The negative one is that it has created an opportunity for *abalone* to be traded on the black market. The positive benefit is that it has led to a mariculture industry near Hermanus.

- 7.1 What is *abalone*? (1)
 - 7.2 What is the feeding mode of the *abalone*? (1)
 - 7.3 What is the black market? (1)
 - 7.4 Why is the number of perlemoen caught by divers regulated? (2)
 - 7.5 How can mariculture of perlemoen not be illegal? (2)
 - 7.6 What should be done to prevent illegal poaching of *abalone*? (2)
 - 7.7 Name TWO other animals that are globally known as being threatened by poaching. (2)
 - 7.8 How can mariculture help with the conservation of perlemoen? (2)
 - 7.9 What should happen to the dead *abalone* that is confiscated from poachers? (1)
- (14)

Question 8

Study the graph below showing the effects of unsaturated sewage on three organisms in a river in KwaZulu-Natal and then answer the questions that follow.

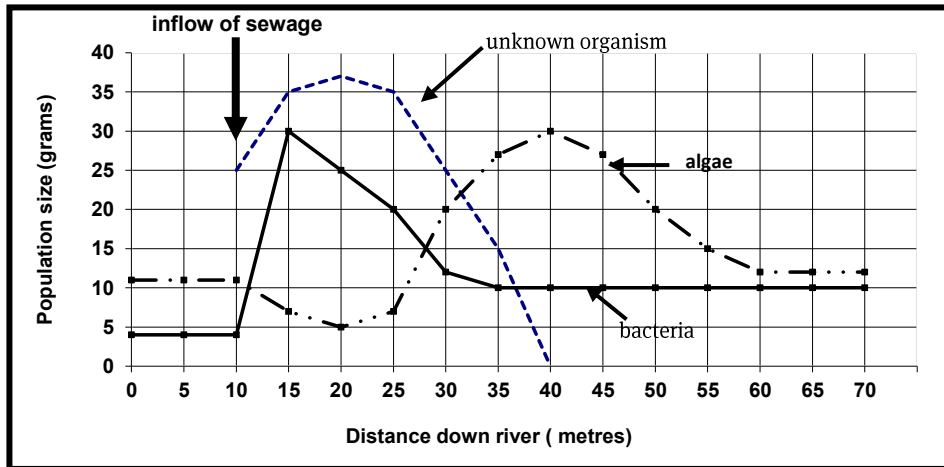

- 8.1 Account for the increase in the population size of the unknown organism between 10 and 20 metres down the river. (1)
 - 8.2 Name ONE possible factor that could have caused the subsequent decrease in the population size of the unknown organism. (1)
 - 8.3 What process is associated with the sudden increase in algal growth? (1)
 - 8.4 Why did the algae population decrease in size between 10 and 20 metres down the river? (1)
 - 8.5 Name TWO water-borne diseases that could be found in untreated sewage. (2)
- (6)

Question 9

In developing countries approximately 75% of households are reliant on biomass fuels such as wood and cow dung. Despite extensive electrification of homes in South Africa, more than half of our households are still primarily dependent on solid fuels for cooking and heating. As a result the levels of indoor air pollution often exceed international guidelines. The graph below categorises domestic fuels, looking at cost of the fuel as well as emissions, that is, how safe they are in terms of indoor air quality.

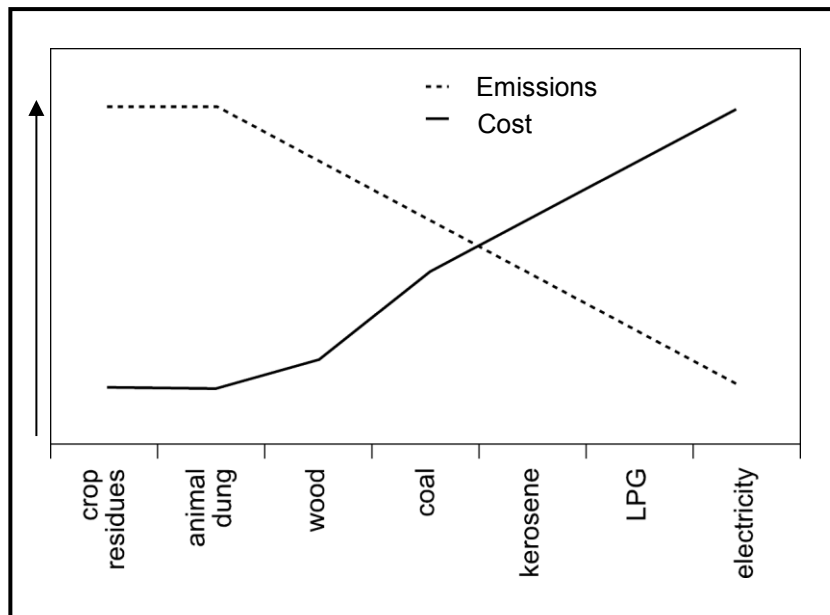

- 9.1 State an aim for the investigation. (2)
- 9.2 Formulate an appropriate hypothesis that can be confirmed by the data provided (2)
- 9.3 Name TWO fuel sources that will be easily and cheaply obtained in a rural environment. (2)
- 9.4 How many households in developing countries use non-biomass fuels? (1)
- 9.5 What is the relationship between the cost of the fuel and the safety for indoor use? (2)
- 9.6 Indoor air pollution has been associated with Acute Lower Respiratory Infections such as pneumonia. In children under the age of five, Acute Lower Respiratory Infections account for approximately 14% of deaths.
 - 9.6.1 Why are respiratory infections in children under the age of five associated with indoor pollution? (1)
 - 9.6.2 Why would small children under the age of five suffer infections from pollution? (1)

- 9.7 Assuming biomass fuels must still be used for cooking and warmth, describe TWO inexpensive ways in which people living in these homes could reduce the negative effect of indoor pollutants on young children. (2)
(13)

Question 10

Most aquatic organisms get their oxygen directly from the water. Varying water temperatures have different effects on organisms. Oxygen content in water is higher at lower water temperatures and in running water. Higher temperatures have a beneficial effect on body processes of plants and animals because they increase metabolic rate or energy output which can then increase growth.

- 10.1 Rivers and estuaries may become polluted by hot water released from the cooling towers of power stations. Suggest how thermal pollution can cause death of aquatic organisms. (2)

The sand hopper, *Urothoe*, is a small crustacean which lives in river estuaries. An investigation was carried out into the effects of thermal pollution on the growth of *Urothoe*. Graph 1 below shows the results of the study.

Graph 1: Mean head length in *Urothoe* from June 1967 to September 1968

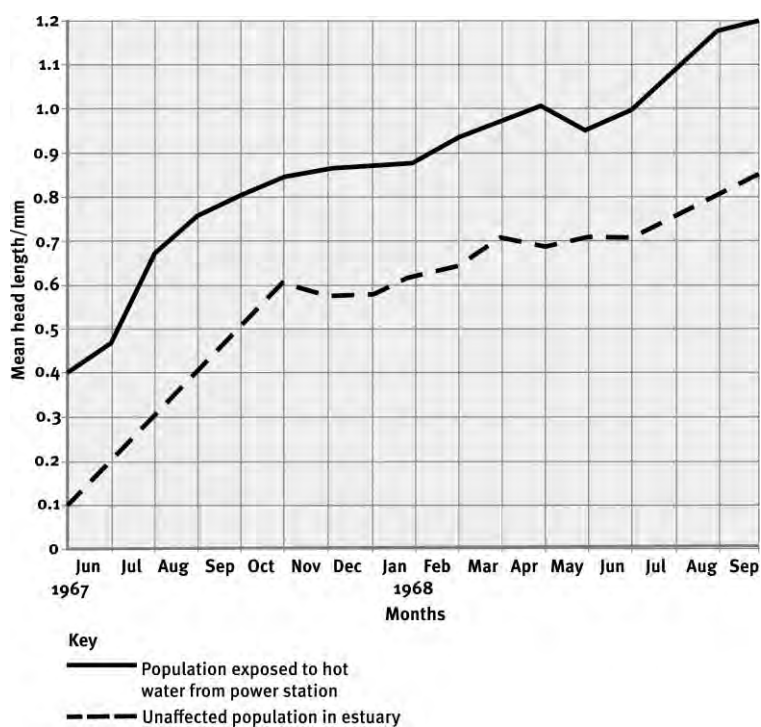

- 5.2 Compare the head lengths of the two populations at the beginning of January 1968 and suggest an explanation for the difference. (4)

Graph 2 below shows the effect of thermal pollution on the percentage of female sand hoppers carrying eggs from the beginning of March to the end of August 1968. Females carry eggs only during the breeding season.

Graph 2: Effect of thermal pollution on the percentage of female sand hoppers carrying eggs from the beginning of March to the end of August 1968.

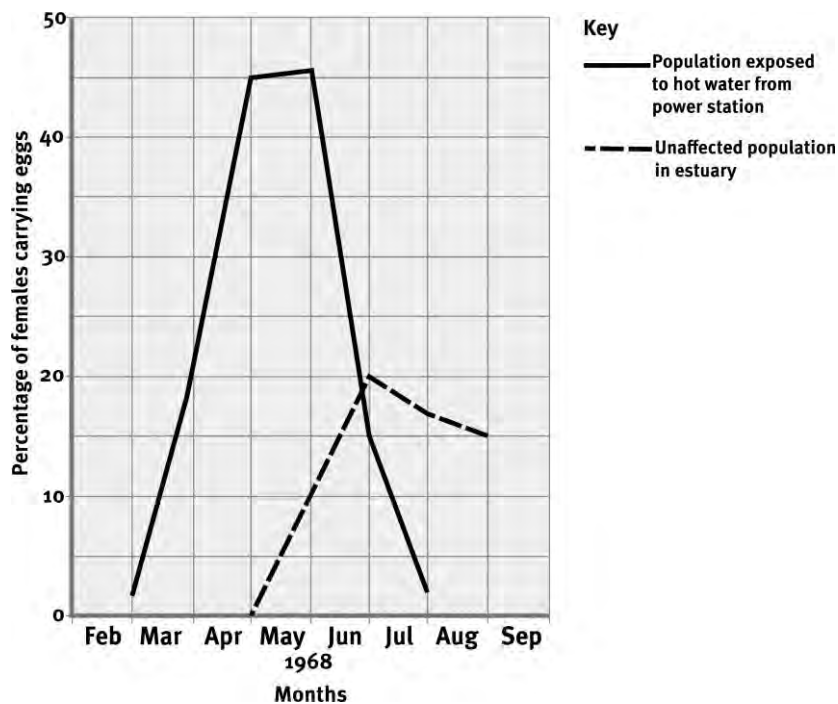

5.3 How can you explain the difference between the two curves? (4)

5.4 Do you think thermal pollution is an advantage or a disadvantage to sand hoppers? Give a reason for your answer. (4)

A nuclear power station was built near an estuary in which fish prey on sand hoppers and their eggs. Fisherman noticed, about ten years after the nuclear power station began operating, that they were catching monster fish, fish that were twice the size of fish before the nuclear power station was built. The fishermen were pleased with their catches because they were able to sell the fish their families could not eat. Scientific investigation subsequently showed that the nuclear power station was responsible for thermal pollution and the release of radioactive materials into the estuary.

5.5 Give a reason why the local people should not eat the monster fish. (2)

(16)

Question 11

Between 1882 and 1952 the proportion of the Earth's land surface classified as desert increased from 9.4% to 23.3%. The shift to desert is still going on. The most affected

areas are the semi-arid lands around the fringes of deserts, such as the Sahel, the belt of land lying to the south of the Sahara Desert in Africa. Rainfall records from the Sahel show that rainfall has been below average for the last 20 years of the study and the decline is getting worse. The degradation of semi-arid land into desert is called desertification. Study the graph below and then answer the questions that follow.

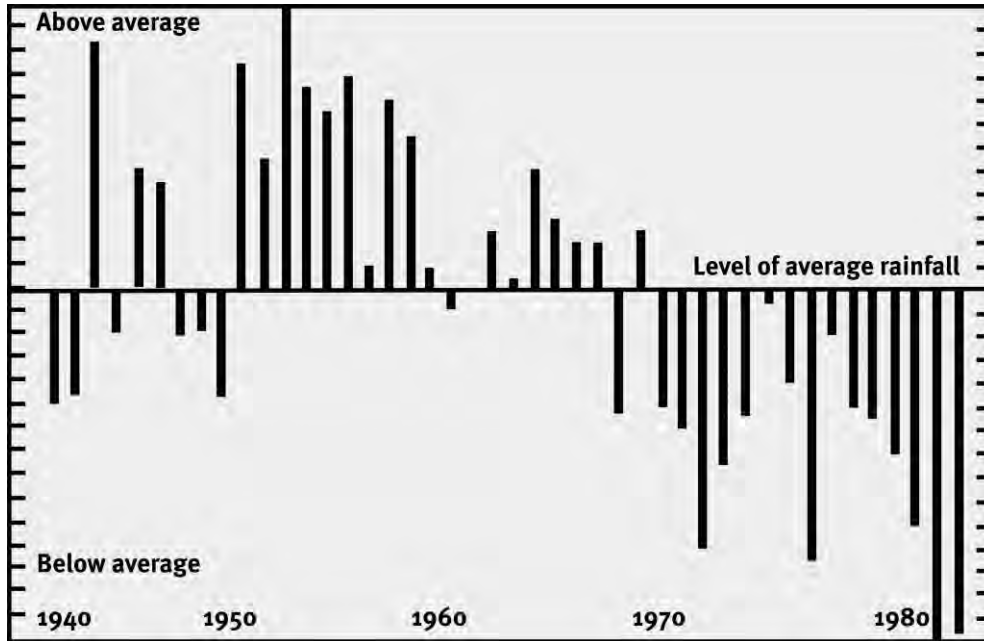

The rainfall pattern in the Sahel. The bars show the departure from the normal rainfall. [Source: Atlas of living world, Weidenfeld and Nicolson]

- 11.1 State the effects of overgrazing and the collecting of wood for fuel on semi-arid land. (2)
 - 11.2 People living in the Sahel have kept herds of sheep and goats for hundreds of years. Suggest TWO reasons why there is continued overgrazing occurring in this region. (2)
 - 11.3 The graph above shows that the rainfall in the Sahel between 1950 and 1968 was above average. How would the increased rainfall have affected farming in the Sahel? (2)
- (5)

Question 12

Read the paragraph below and answer the question that follows.

African potato issues

African potato (*Hypoxis hemerocaluidea*) is widely used for traditional medicine in South Africa and regarded as a natural resource. It is commercially used to cure human ailments such as testicular tumours, enlargement of the prostate gland, urinary infections and stomach aches. It is also used as a laxative. Research has shown that 73 tonnes or 428 000 bulbs are widely harvested by sangomas and collectors in KwaZulu–Natal every year. Claims that the extract of African potato can be used to treat diseases like HIV/Aids and cancer has put this traditional medicine under the spotlight.

12 Describe the over-exploitation of the African potato by referring to the consequences and describe at least THREE strategies to ensure its sustainability. Also state your opinion on what needs to be done to clear up the misconception that African potato can cure HIV/Aids.

NOTE:

No marks will be awarded for answers in the form of flow charts and diagrams. (15)

Question 13

Write a critical essay on the causes and effects of deforestation. (15)

TOTAL MARKS: 174

Answers to Questions

Question 1

- | | | |
|------|------|------|
| 1.1 | D ✓✓ | (2) |
| 1.2 | C ✓✓ | (2) |
| 1.3 | A ✓✓ | (2) |
| 1.4 | B ✓✓ | (2) |
| 1.5 | A ✓✓ | (2) |
| 1.6 | A ✓✓ | (2) |
| 1.7 | C ✓✓ | (2) |
| 1.8 | B ✓✓ | (2) |
| 1.9 | D ✓✓ | (2) |
| 1.10 | C ✓✓ | (2) |
| 1.11 | D ✓✓ | (2) |
| 1.12 | A ✓✓ | (2) |
| 1.13 | C ✓✓ | (2) |
| | | (26) |

Question 2

- | | | |
|------|--|------|
| 2.1 | Chlorofluorocarbons (CFCs) ✓ | |
| 2.2 | Atmosphere ✓ | |
| 2.3 | Acid rain ✓ | |
| 2.4 | Culling ✓ | |
| 2.5 | Primary ✓ | |
| 2.6 | Chlorofluorocarbons (CFCs) ✓ | |
| 2.7 | Global warming ✓ | |
| 2.8 | Deforestation ✓ | |
| 2.9 | Overgrazing ✓ | |
| 2.10 | Bioamplification / biomagnifications ✓ | |
| 2.11 | DDT ✓ | |
| 2.12 | Poaching ✓ | |
| 2.13 | Endemic ✓ | (13) |

Question 3

- 3.1 True ✓
- 3.2 True ✓
- 3.3 False ✓
- 3.4 False ✓
- 3.5 True ✓
- 3.6 True ✓
- 3.7 True ✓
- 3.8 True ✓
- 3.9 False ✓
- 3.10 False ✓
- 3.11 True ✓
- 3.12 True ✓ (12)

Question 4

- 4.1 E ✓
- 4.2 J ✓
- 4.3 G ✓
- 4.4 K ✓
- 4.5 C ✓
- 4.6 I ✓
- 4.7 B ✓
- 4.8 F ✓
- 4.9 D ✓
- 4.10 L ✓ (10)

Question 5

5.1 Bar graph ✓ showing amount of solid waste generated in a town over a period of 6 years ✓

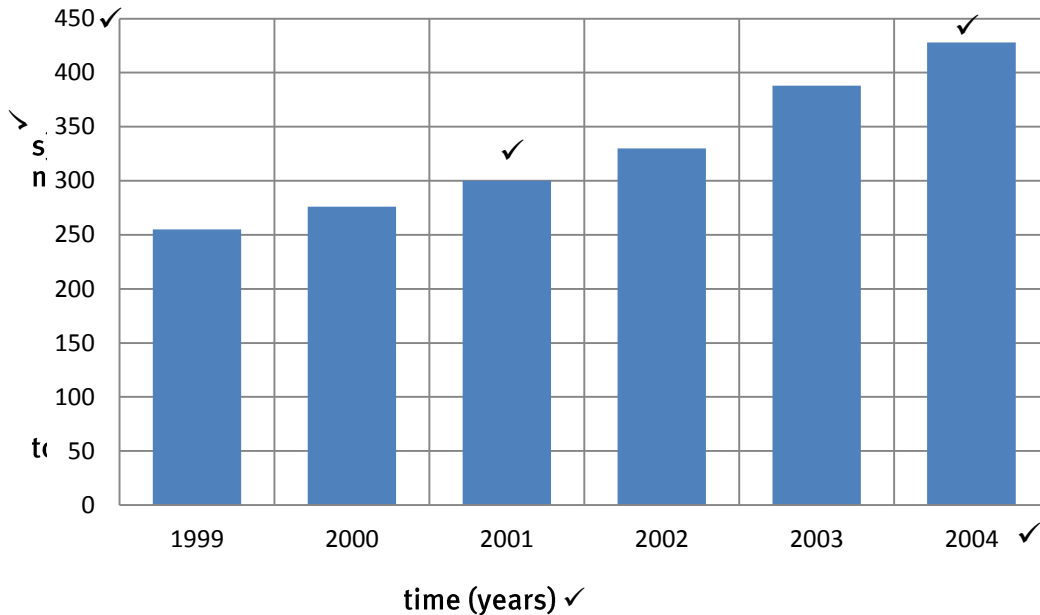

5.2 An increase in solid waste production over time ✓ (8)

5.3 2004 ✓ (1)

5.4 $388 - 300 = 88$ tonnes ✓ (2)

5.5 Old household / office / medical / industrial equipment ✓
 Building rubble ✓
 Old machines / cars, etc. ✓
 Waste containers, tins, bottles, plastics and packages ✓ (any 2) (2)

5.6 Landfills ✓ – Stabilises land / ground that can be used for other reasons. ✓
 Recycling ✓ – Reduces waste and reuses resources. ✓
 Alternative methods of packaging ✓ – Reduces production of undesirable packaging and waste. ✓ (any 2) (4)

(18)

Question 6

- 6.1 Sewage ✓
 Farm chemicals / fertilisers ✓
 Industrial manufacturing processes ✓
 Refuse ✓
 Mining ✓ (any 2) (2)
- 6.2 Diarrhoea ✓ (1)
- 6.3 Patients visiting doctors ✓
 Hospitals or clinic records ✓
 Surveys ✓
 Sale of pharmaceuticals in chemists or pharmacies ✓ (4)
- 6.4 Purifying water ✓
 Burying / burning waste ✓
 Removing breeding grounds ✓
 Washing clothes, food and general hygiene using soap ✓ (any 2) (2)
- 6.5 Water purification ✓
 Waste collection ✓
 Landfills ✓
 Recycling ✓
 Chemical sprays ✓
 Laws ✓
 Fines ✓ (any 2) (2)

(11)

Question 7

- 7.1 Large sea snails that feed on kelp ✓ (1)
- 7.2 Herbivore ✓ (1)
- 7.3 Illegal trade in an organism for the highest price ✓ (1)
- 7.4 To prevent over exploitation ✓
 Conservation to allow for managed use ✓ (2)
- 7.5 Mariculture of perlemoen is not illegal as it is an industry that can provide resources to meet the needs of people ✓ and at the same time prevent overexploitation. ✓ (2)

- 7.6 Policing the coast lines ✓
 Introducing higher fines ✓ and legal judgments ✓ for poachers (any 2) (2)
- 7.7 Rhino, ✓ elephant ✓ (2)
- 7.8 By introducing a regulated market ✓ and assist population growth management ✓ (2)
- 7.9 Sold to raise funds that can be directed into its conservation and breeding programmes. ✓ (1)
- (14)

Question 8

- 8.1 Unknown organism arises from sewage and has increased in population size due to the increase in nutrient content ✓ of the water from the sewage that supports its growth. (1)
- 8.2 Decrease in nutrient (food) content / Increase in oxygen / Competition between it and other bacteria ✓ (1)
- 8.3 Eutrophication ✓ (1)
- 8.4 Decreased light intensity in river ✓ at position of sewage inflow. (1)
- 8.5 Cholera ✓ / typhoid ✓ / dysentery ✓ (any 2) (2)
- (6)

Question 9

- 9.1 To determine the amount of indoor air pollution ✓ associated with different fuel sources ✓ (2)
- 9.2 The cheaper the fuel ✓ the more indoor air pollution / emissions. ✓ (2)
- 9.3 Crop residue ✓
 Animal dung ✓
 Wood ✓ (any 2) (2)
- 9.4 75% ✓ (1)
- 9.5 As the cost of the fuel increases, ✓ there is less indoor pollution ✓ / inversely proportional (2)
- 9.6.1 They spend most of their life indoors. ✓ (1)
- 9.6.2 Their immune systems are not fully developed. ✓ (1)
- 9.7 Open doors and windows while cooking. ✓
 Wear warmer clothes. ✓
 Cook during the day, while the children play outside. ✓

Cook outside. ✓

(any 2) (2)

(13)

Question 10

10.1 It lowers the oxygen content of water causing suffocation. ✓ Decreases enzyme activity and denatures proteins. ✓ (2)

10.2 The population exposed to hot water from the power station had a larger head length (0,4 mm) ✓ than the unaffected population in the estuary (0,1 mm). ✓ Higher temperatures in water may increase metabolic rate ✓ which can then increase growth. ✓ (4)

10.3 Hot water increased the percentage females carrying eggs (50%) ✓ compared to the unaffected population in the estuary (20%). ✓ Hot water caused the breeding season to occur earlier in the year (March to April) ✓ than the unaffected population in the estuary (May to June). ✓ (4)

10.4 Advantage, ✓ as there is a greater percentage of females carrying eggs ✓ which could increase the population significantly ✓ compared to the unaffected population. ✓

OR

Disadvantage, ✓ as the breeding season is not the same as the other population ✓ and could result in an isolated population ✓ compared to the unaffected population ✓. (4)

10.5 Because it is contaminated with radioactive materials ✓ that may be hazardous to health ✓ (2)

(16)

Question 11

11.1 Effects of overgrazing and the collecting of wood on semi-arid land:

Decreased biodiversity ✓

Exposure of soil to the elements ✓

Nutrient loss ✓

Loss of water content (drying out) ✓

Increased wind movement / erosion ✓

Increased water erosion ✓

(any 2) (2)

11.2 Overpopulation ✓ Increased population growth ✓ High density of sheep and goats ✓ Ongoing grazing prevents the plants from growing, ✓ reproducing properly. ✓ (any 2) (2)

11.3 Increased run-off / erosion ✓
Soil nutrients washed away / plants reduced in number ✓
OR
Delayed positive effect ✓
Increased food production / growth ✓ (2)

(6)

Question 12

Consequences of over exploitation:

Overexploitation for remedies and pharmaceuticals by foreign investment companies ✓ reduces income into South Africa for development and employment in our own country. ✓

Overexploitation reduced quantity and population size ✓ leading to extinction of the plant. ✓

Overexploitation destabilises the natural environment and the ecosystems ✓ of which the plant is a part leaving associated animals, pollinators etc., without food and homes. ✓

(6)

Sustainable strategies that can be used:

Create farms or botanical gardens ✓ to grow the plants in to increase the number and protect the population. ✓

Start seed banks and nurseries ✓ to ensure continued source of genetic diversity and plant propagation. ✓

Enforce laws ✓ for protection of indigenous plants. ✓

Levy high fines ✓ for unauthorised exploitation. ✓

(any 3 × 2)(6)

To clear up the misconception that African potato can cure HIV/Aids:

Conduct information campaigns about the scientifically proven and accepted cures for HIV/AIDS. ✓

Initiate education campaigns about the values and dangers concerning alternative HIV/AIDS treatments. ✓

Conduct tests on the medicinal value of the plant and initiate scientific medical trials using the extracted compounds to determine their effects on HIV/Aids. ✓ (15)

Question 13

Raw materials for pulp mills ✓ + explanation ✓

Subsistence needs ✓ + explanation ✓

Use of timber in mining ✓ + explanation ✓

Ecological threats ✓ + explanation ✓

Agriculture / farming ✓ + explanation ✓

Road building ✓ + explanation ✓

Furniture ✓ + explanation ✓

Poverty alleviation and employment ✓ + explanation ✓

Genetic storehouse threats ✓ + explanation ✓

(any 6 × 2) (12)

Own opinion ✓ with a reason ✓

(1)

Synthesis ✓

(1)

(15)

TOTAL MARKS: 175

Example examination papers

Grade 12

Life Sciences

Paper 1

Exemple examination paper

Via Africa

MARKS: 150

TIME: 2½ hours

INSTRUCTIONS AND INFORMATION

Read the following instructions carefully before answering the questions.

1. Answer ALL the questions.
2. Write ALL the answers in your ANSWER BOOK.
3. Start the answers to each question at the top of a NEW page.
4. Number the answers correctly according to the numbering system used in this question paper.
5. Present your answers according to the instructions of each question.
6. ALL drawings should be done in pencil and labelled in blue or black ink.
7. Draw diagrams or flow charts only when asked to do so.
8. The diagrams in this question paper are NOT necessarily all drawn to scale.
9. Do NOT use graph paper.
10. You should use non-programmable calculators, protractors and compasses where necessary.
11. Write neatly and legibly.

Example examination papers

SECTION A

QUESTION 1

1.1 Various options are provided as possible answers to the following questions. Choose the correct answer and write only the letter (A to D) next to the question number (1.1.1 to 1.1.10) in your ANSWER BOOK, for example 1.1.11 D.

1.1.1 Which of the following is TRUE about Anaphase I of meiosis?

- A Chromosomes arranged at equator.
- B Chromosomes are pulled to the poles.
- C Centromere splits.
- D Chromatids of a chromosome separate and move to the poles.

1.1.2 Study the diagram of a developing foetus inside the uterus.

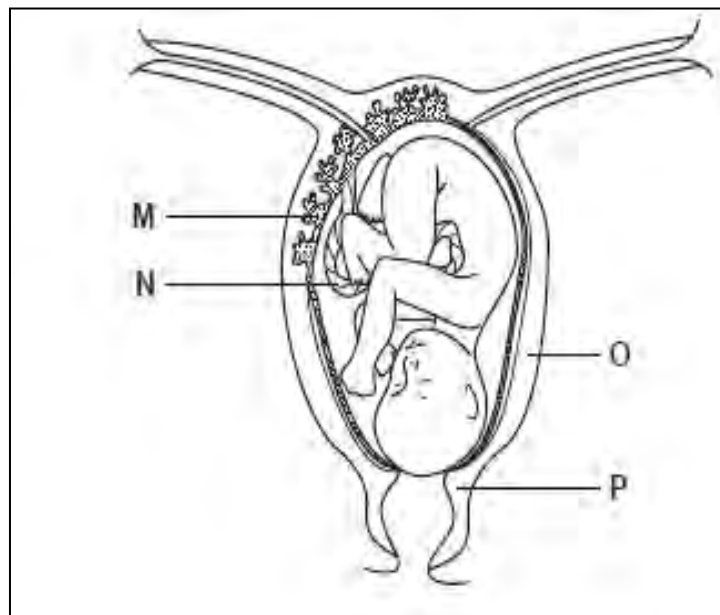

Which labelled part secretes its own progesterone after about the twelve week of pregnancy?

- A M
- B N
- C O
- D P

Example examination papers

1.1.3 The withdrawal and rhythm methods are regarded as..... methods of contraception.

- A chemical
- B natural
- C surgical
- D mechanical

1.1.4 Which of the following combination of structures is responsible for accommodation?

- A lens , ciliary muscle, suspensory ligaments
- B circular muscle, lens, suspensory ligaments
- C ciliary muscle, pupil, suspensory ligaments
- D radial muscle, lens, suspensory ligaments

QUESTION 1.1.5 and QUESTION 1.1.6 are based on the diagram of a reflex arc shown below.

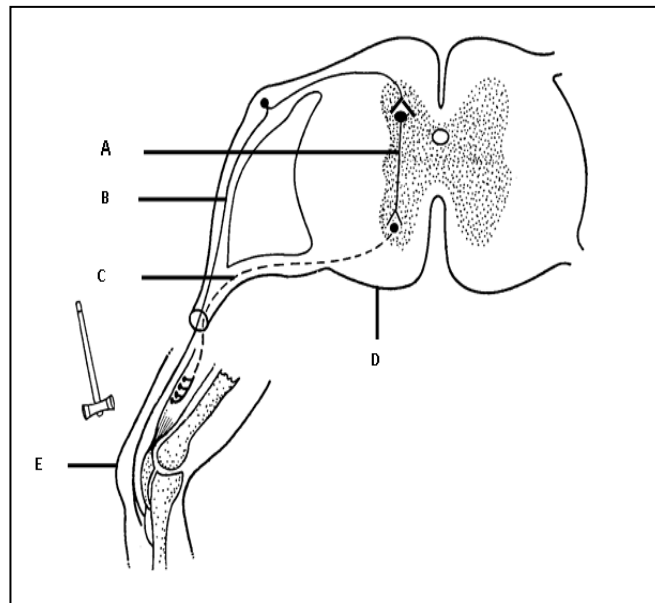

1.1.5 Part **B** indicates the ...

- A dendrite of the motor neuron.
- B axon of the motor neuron.
- C dendrite of the sensory neuron.
- D axon of the sensory neuron.

1.1.6 The correct sequence in which impulses move from the receptor to the effector in the reflex arc above, is ...

Example examination papers

- A $A \rightarrow B \rightarrow C$
- B $B \rightarrow C \rightarrow A$
- C $C \rightarrow A \rightarrow B$
- D $B \rightarrow A \rightarrow C$

1.1.7 The diagram shows the activity of the pituitary gland in the secretion of a hormone from the thyroid gland.

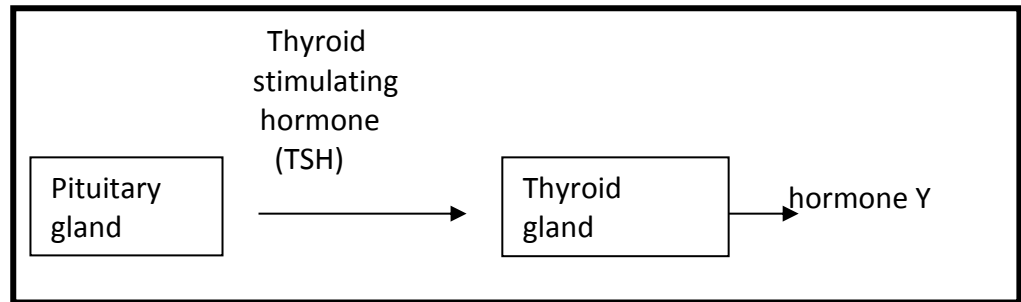

Identify hormone Y.

- A Adrenalin
 - B Insulin
 - C Thyroxin
 - D Glycogen
- 1.1.8 Which of the following is an exocrine gland?
- A Thyroid
 - B Pancreas
 - C Adrenal
 - D Pituitary
- 1.1.9 The diagrams show structures within the human skin under two different external conditions.

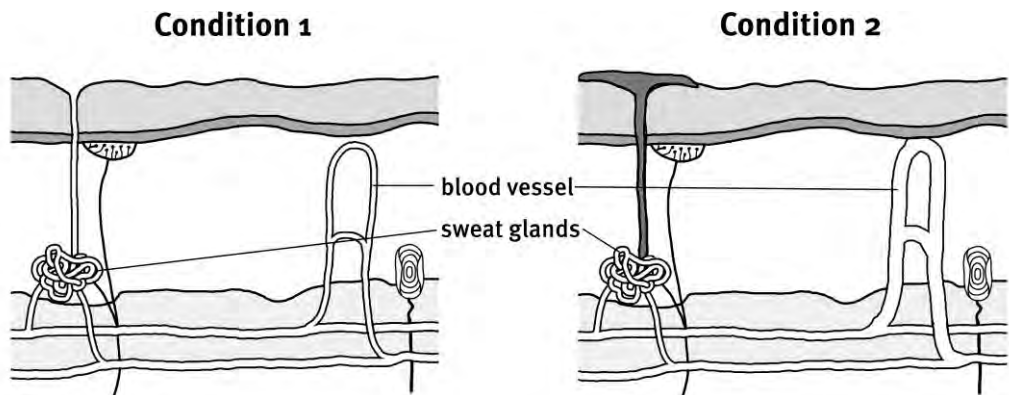

Example examination papers

What are the external conditions?

	Condition 1	Condition 2
A	Cold	Hot
B	Hot	Cold
C	Cold	Cold
D	Hot	Hot

- 1.1.10 Which one of the following steps can be carried out as a control for the experiment, shown below?

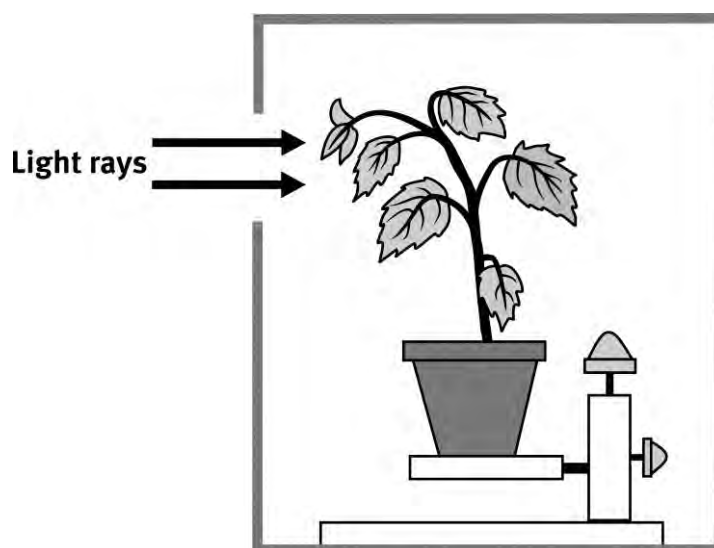

Step:

- 1 Seal the opening in the dark box.
 - 2 Rotate a similar plant on a clinostat in a dark box.
 - 3 Take the plant outside the box and expose it evenly to light.
 - 4 Rotate a similar plant on a clinostat with no box.
- A Only step 1.
 B Only step 2.
 C Steps 1 and 2.
 D Steps 1, 3 and 4.

(10 x 2) (20)

- 1.2 Give the correct **biological term** for each of the following descriptions. Write only the term next to the question number (1.2.1–1.2.8) in your ANSWER BOOK.

- 1.2.1 Fertilisation of the ovum by a sperm cell inside the body of the female.
- 1.2.2
- 1.2.3 The system responsible for chemical co-ordination in the human body.

Example examination papers

1.2.4 The gland that secretes oxytocin.

1.2.5 The 'master gland'.

1.2.6 The condition suffered by a person when the core body temperature is decreased so much that the body's homeostatic control mechanism can no longer cope

1.2.7 The growth movement of plant organs to the stimulus of light.

1.2.8 The amount of carbon dioxide emitted due to the consumption of fossil fuels by a particular person.

The process by which fertile land becomes desert, typically as a result of drought, deforestation or inappropriate agriculture.

(8)

1.3 Indicate whether each of the statements in COLUMN I applies to **A ONLY**, **B ONLY**, **BOTH A AND B** or **NONE** of the items in COLUMN II. Write **A only**, **B only**, **both A and B**, or **none** next to the question number (1.3.1–1.3.5) in the ANSWER BOOK.

COLUMN I		COLUMN II
1.3.1	Development in which a hatchling is capable of moving around on its own and can feed itself.	A: Altricial B: Precocial
1.3.2	Method of reproduction in which the foetus is retained in the mother's uterus and is nourished through an umbilical cord	A: Ovipary B: Vivipary
1.3.3	Increase the permeability of the walls of the distal convoluted tubule and collecting tubule. .	A: ADH B: LH
1.3.4	It promotes the development of flowers.	A: Gibberellins B: Abscisic Acid
1.3.5	Ozone depletion.	A: CFCs B: HFCs

(5 x 2)

(10)

Example examination papers

1.4 Study the diagram below and answer the questions that follow.

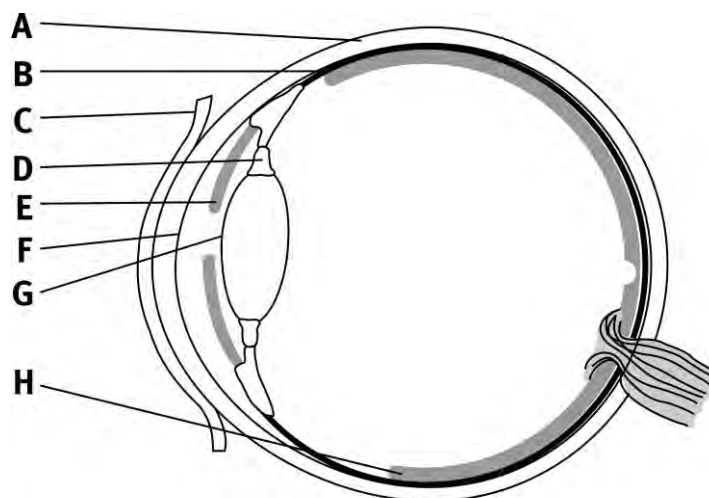

Longitudinal section through a human eye

1.4.1 Write down only the letter (A–H) of the part that:

- (a) is transparent and plays an important role in accommodation. (1)
 - (b) helps the eye to maintain its shape. (1)
 - (c) causes the lens to change its shape. (1)
 - (d) responds to light intensity. (1)
 - (e) Prevents internal reflection of light. (1)
- (5)**

1.5

The amount of sodium ions that is excreted can be regulated.

- 1.5.1 Which organ plays a vital role in the excretion of sodium ions to help the body to maintain healthy salt levels? (1)
- 1.5.2 (a) Which gland plays a role in the regulation of the salt levels? (1)
 (b) Give the name of the hormone secreted by the gland mentioned in question 1.5.2 (a) which helps in the maintaining of the salt levels.
- 1.5.3 (1)
 Explain what happens when there is a shortage of sodium in the blood. (4)
- (7)**

TOTAL SECTION A: 50

Example examination papers

SECTION B

QUESTION 2

- 2.1 Study the diagram below of a phase in meiosis and answer the questions that follow.

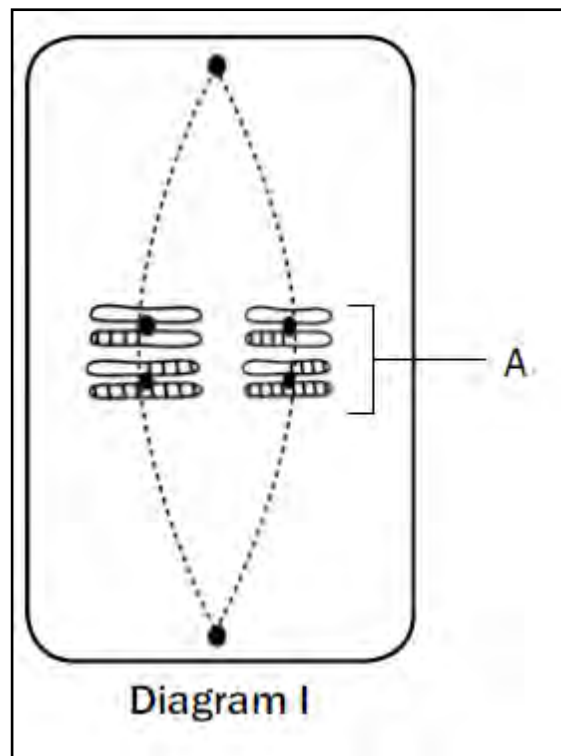

- 2.1.1 Explain which phase of meiosis is represented above. (2)
- 2.1.2 How many chromosomes would be present in each daughter cell at the end of meiosis in this cell? (1)
- 2.1.3 Describe what takes place in the cell after the phase shown in Diagram I. (3)
- 2.1.4 Draw a labelled diagram of the structures labelled **A**. (3)
(9)

Example examination papers

2.2 Study the diagram below and answer the questions that follow.

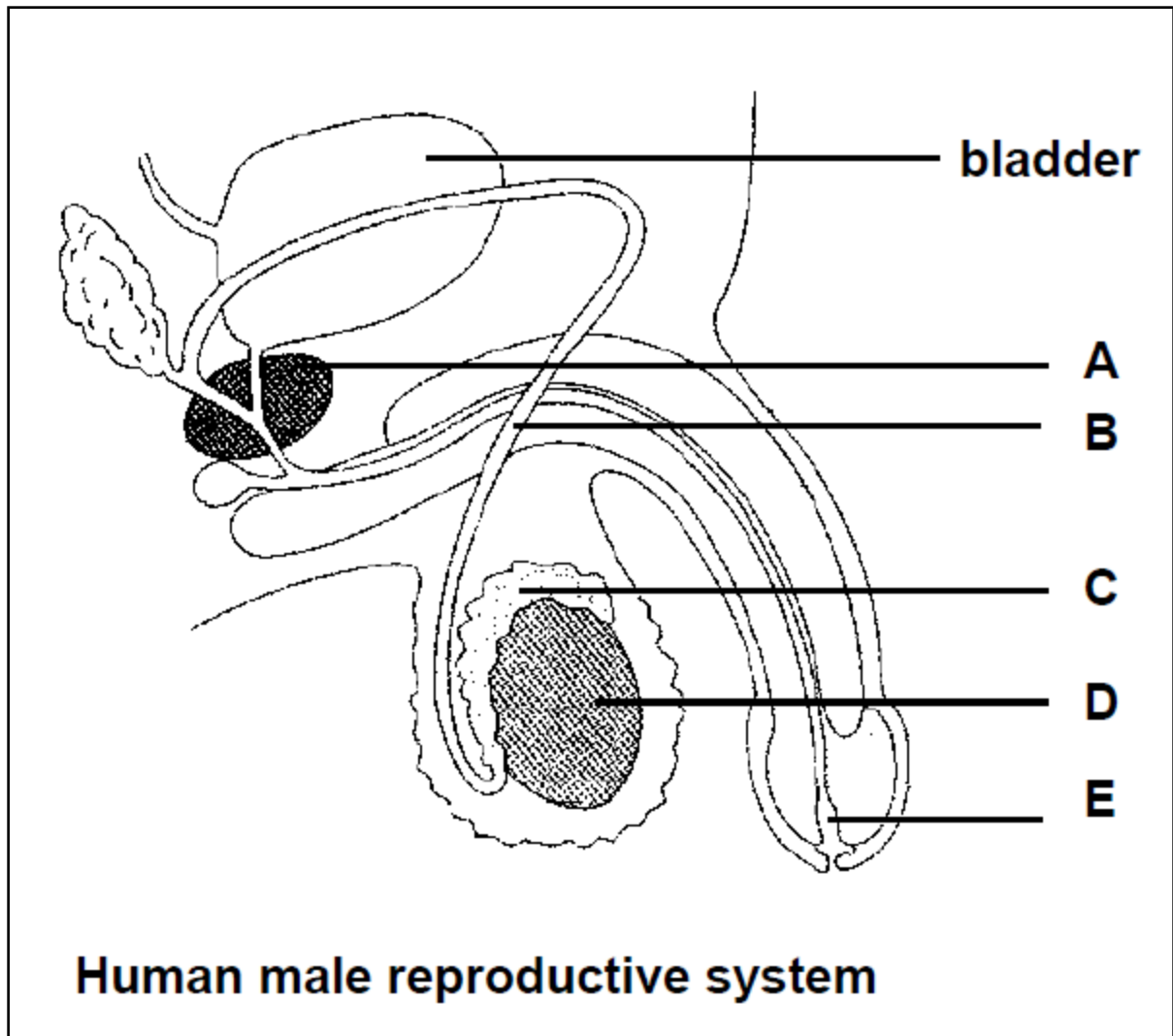

2.2.1 Label each of the following structures:

- (a) B (1)
- (b) C (1)
- (c) E (1)

2.2.2 Give the function of the parts that are labelled

- (a) A (1)
- (b) D (1)

Example examination papers

2.2.3 When a man has a vasectomy, the tubule labelled B is cut off and sealed on both sides.

(a) Explain how this procedure will act as a method of contraception. (2)

(b) Will it be possible for a man who is HIV positive to pass the HI virus to another person after he undergoes a vasectomy? Explain (2)

2.2.4 Explain why it is necessary for part D to 'hang outside' the body of the male. (2)
(11)

2.3 Study the graph below that shows the levels of hormones as well as the changes in the ovary and uterus during the menstrual cycle.

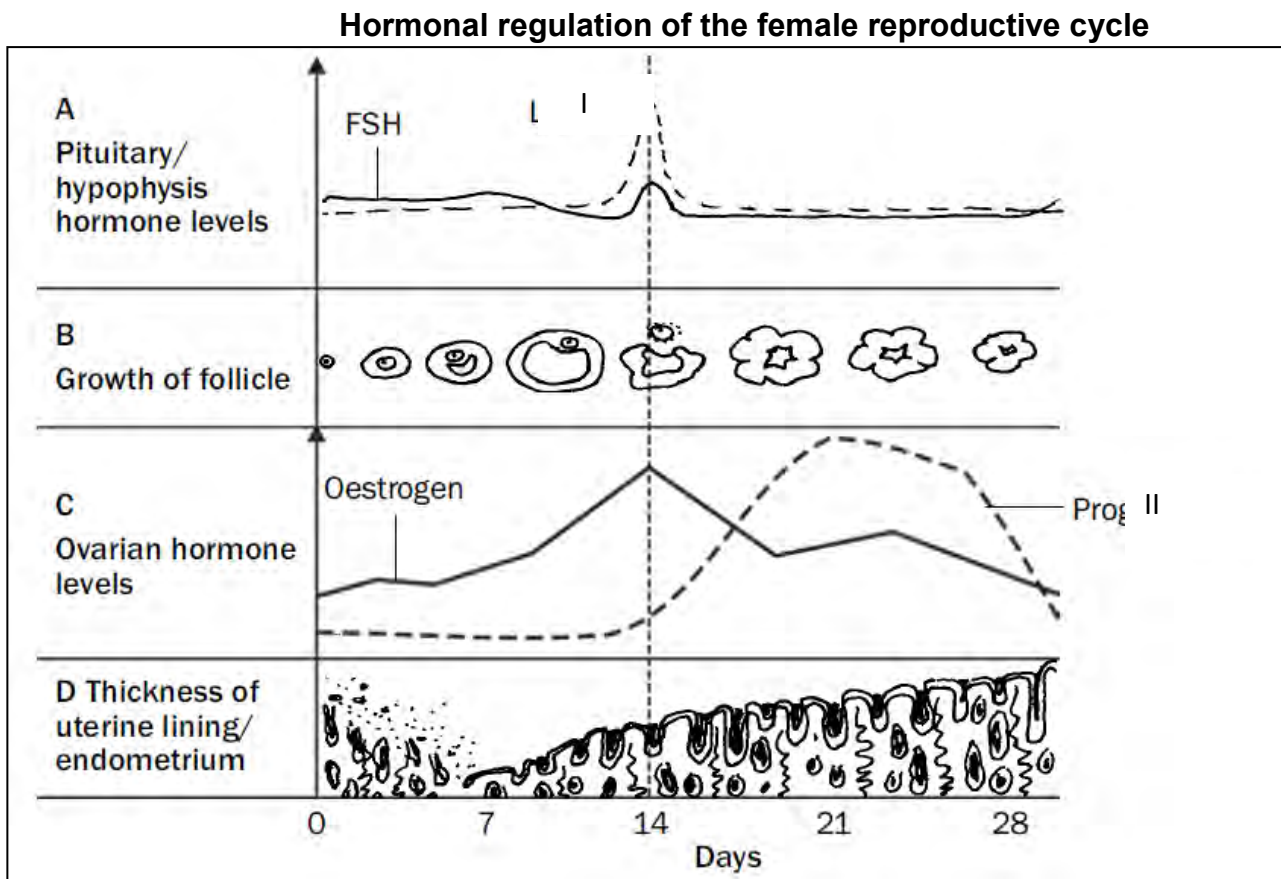

2.3.1 Identify hormones I and II (2)

2.3.2 On which day does ovulation take place? (1)

2.3.3 Between which days does menstruation take place? (2)

Example examination papers

- 2.3.4 State ONE function of FSH during the menstrual cycle. (1)
- 2.3.5 What deductions can you make from the graphs by referring to the interaction between oestrogen and FSH (2)
- 2.3.6 Fertilisation did not take place. Motivate this statement with evidence from the above diagram. (2)
(10)

2.4

Choosing a contraceptive method	
We have reached the stage where unplanned pregnancies, really should be rare, because of the range of good methods of birth control.	
At present there are about 14 reliable ones.	
Contraceptive	Popularity among the various methods of family planning (%)
Pill	25
Male condom	25
Vasectomy	16
Female sterilisation	14
IUD	4
Withdrawal method	4
Rhythm method	3
Contraceptive injection	2
IUS	2
Skin patch	2
Cap/Diaphragm	1
Implant	1
Female condom	0.5
Vaginal ring	0.5

Source: Dr. David Delvin

- 2.4.1 Draw a pie chart to illustrate the above data. Show all workings. (10)
(10)
[40]

QUESTION 3

3.1 Study the diagram below and answers the questions that follow.

Lateral view of the brain

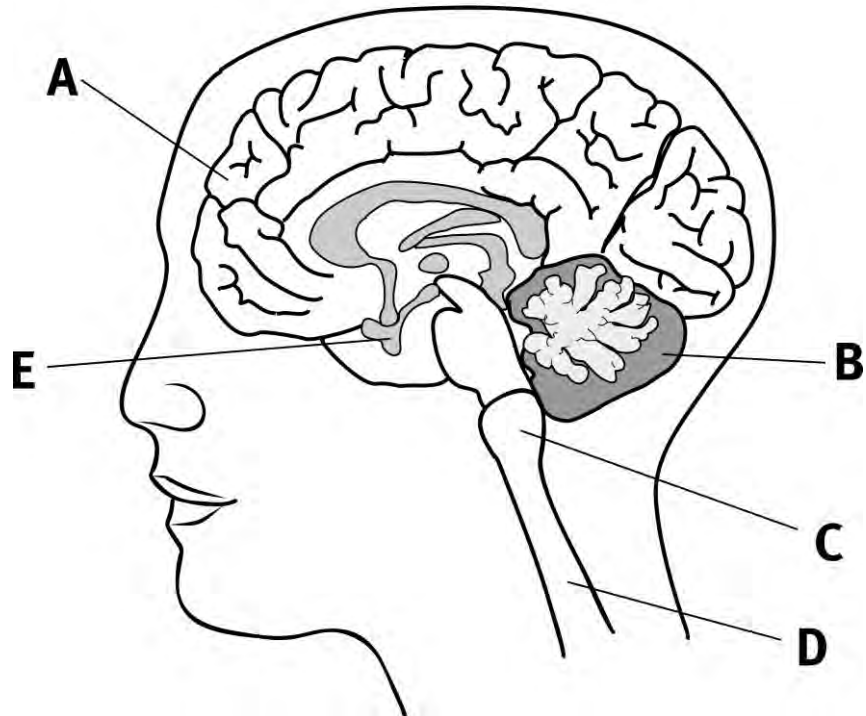

- 3.1.1 Give labels for the parts labeled A – D. (4)
- 3.1.2 Give TWO functions of the part labeled A. (2)
- 3.1.3 People with Alzheimer’s Disease have nerve tissue within the brain which appears to waste away. Give TWO characteristics of people with this disease. (2)
- 3.1.4 Name TWO effects of Dagga on the central nervous system? (2)
- (10)**

Example examination papers

- 3.2 The diagram shows how a certain hormone affects the blood circulation of a person in an emergency.

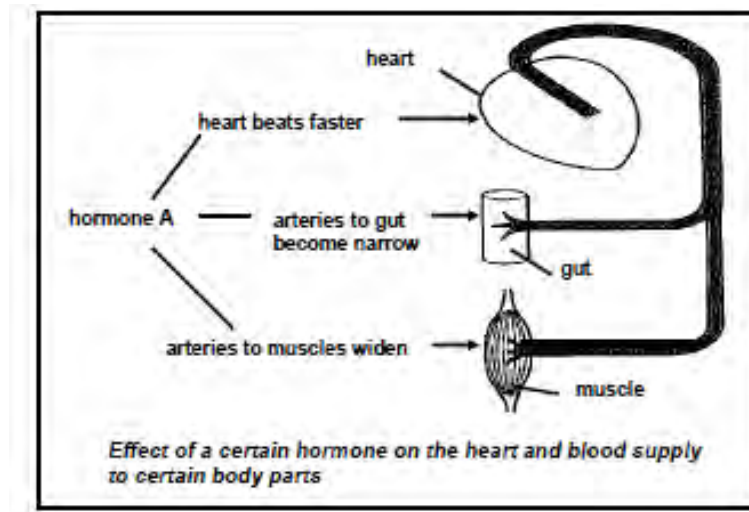

- 3.2.1 Identify hormone A. (1)
- 3.2.2 State the position of the gland that secretes hormone A in the human body. (1)
- 3.2.3 Name the part of the human eye that is also affected by hormone A. (1)
(3)
- 3.3 Study the paragraph below and answer the questions that follow.

Plant defence against herbivory

Poison ivy produces urushiol to protect the plant from herbivores. In humans this chemical produces an allergic skin rash, known as urushiol-induced contact dermatitis.

Source: Wikipedia

- 3.3.1 Why would the plant want to protect itself against herbivores? (2)
- 3.3.2 You were tasked to test the effect of poison ivy on humans. List FIVE planning steps you would consider to perform the experiment. (5)
- 3.3.3 How can the reliability of the results of your investigation be improved? (1)
(8)

Example examination papers

3.4 Study the following diagram and answer the questions that follow:

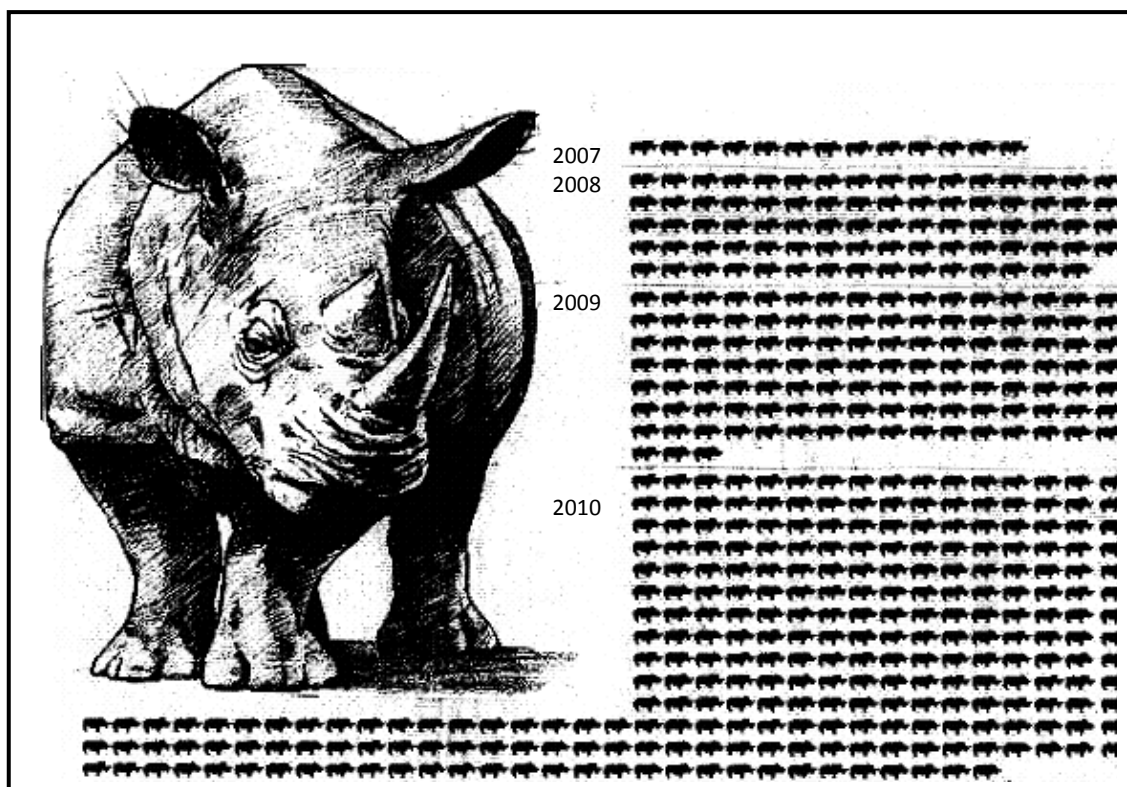

Rhinoceros hunting from 2007 to 2010

Adapted: Volksblad 27/11/2010

- 3.4.1 The reporter lost her information. Use the data above and put it into a table (8)
- 3.4.2 Formulate a hypothesis that will be accepted for the above data. (2)
- 3.4.3 List the dependant variable. (1)
- 3.4.4 List the independent variable (1)
- (12)**

3.5 As the world's population grows, supplies of freshwater are becoming scarcer. Researchers are investigating the use of sea water to irrigate selected crops which can be fed to livestock. The biomass yield of two freshwater-irrigated plants often used for livestock forage, alfalfa (*Medicago sativa*) and Sudan grass (*Sorghum sudanense*), were compared with those of salt-tolerant crops irrigated by seawater, saltbush (*Atriplex spp.*) and sea blite (*Sueda maritima*). The results are shown in the bar chart below.

Example examination papers

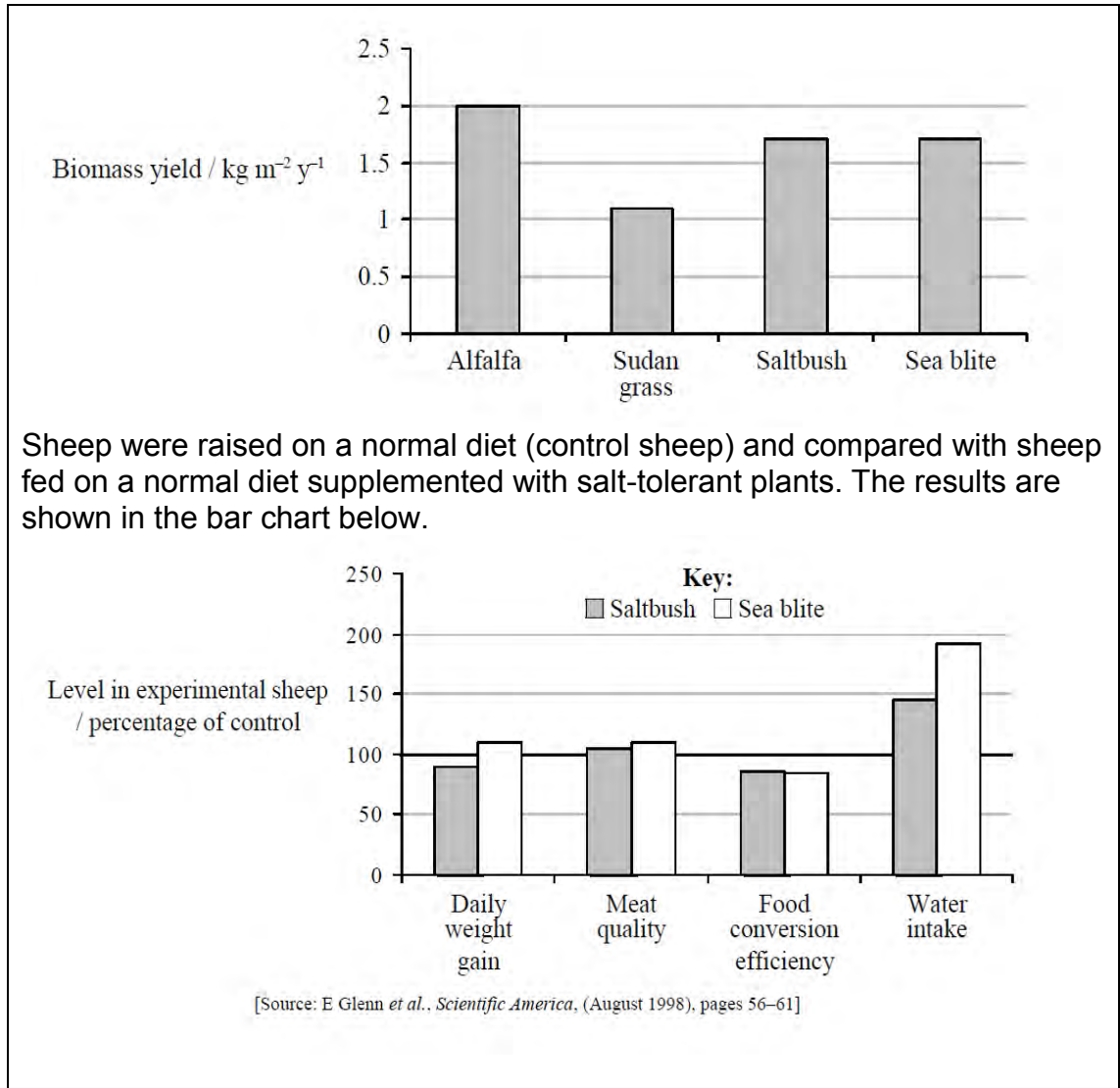

- 3.5.1 Compare the biomass yield of crops irrigated with seawater and freshwater (3)
 - 3.5.2 Compare the daily weight gain in sheep fed on saltbush with sheep fed on sea blite. (2)
 - 3.5.3 Discuss, using only the data provided, the disadvantages of using crops irrigated by seawater to feed sheep. (2)
- (7)**
[40]

TOTAL SECTION B: 80

Example examination papers

SECTION C

QUESTION 4

4.1 Describe how hearing and balance occurs in the human ear.

Content	(17)
Synthesis	(3)
	(20)

NOTE: NO marks will be awarded for answers in the form of flow charts or diagrams.

TOTAL SECTION C:	20
GRAND TOTAL:	150

Example examination papers

Grade 12

Life Sciences

Paper 2

Additional Exemplar

Via Africa

MARKS: 150

TIME: 2½ hours

INSTRUCTIONS AND INFORMATION

Read the following instructions carefully before answering the questions.

1. Answer ALL the questions.
2. Write ALL the answers in your ANSWER BOOK.
3. Start the answers to each question at the top of a NEW page.
4. Number the answers correctly according to the numbering system used in this question paper.
5. Present your answers according to the instructions of each question.
6. ALL drawings should be done in pencil and labelled in blue or black ink.
7. Only draw diagrams or flow charts when asked to do so.
8. The diagrams in this question paper are NOT necessarily all drawn to scale.
9. Do NOT use graph paper.
10. You must use a non-programmable calculator, protractor and a compass where necessary.
11. Write neatly and legibly.

Example examination papers

SECTION A

QUESTION 1

1.1 Four options are provided as possible answers to the following questions. Choose the correct answer and write only the letter (A to D) next to the question number (1.1.1 to 1.1.10) in your ANSWER BOOK, for example: 1.1.11 D.

- 1.1.1 The relationship between nucleic acids and nucleotides is that ...
- A nucleotides are building blocks of nucleic acids.
 - B nucleic acids are building blocks of nucleotides.
 - C nucleotides are larger than nucleic acids.
 - D nucleic acids are found in the nucleus and nucleotides are found in the cytoplasm.
- 1.1.2 What percentage of adenine bases is present in a DNA molecule of 2000 bases, if 400 of the bases are cytosine?
- A 20
 - B 30
 - C 40
 - D 60
- 1.1.3 In DNA, if the sequence of bases on one strand is AGG, the corresponding bases on the complementary strand are ...
- A ACC.
 - B TAA.
 - C CTT.
 - D TCC.
- 1.1.4 Dolly the sheep was cloned by combining...
- A two unfertilised sheep egg cells.
 - B a sheep egg cell with a sheep sperm cell.
 - C a sheep diploid body cell with a sheep egg cell from which the nucleus was removed.
 - D skin cells from two different sheep

Example examination papers

- 1.1.5 The numbers I, II, III and IV below refer to four populations of frogs. These populations are represented diagrammatically by circles. Overlapping circles show populations that are capable of interbreeding to produce fertile offspring.

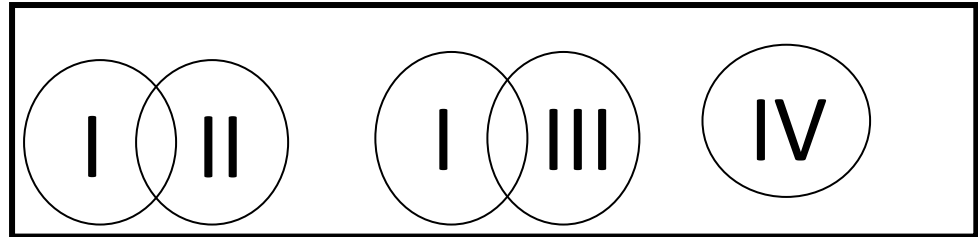

It would be reasonable to conclude that ...

- A if population II were to die out, there would be two different species remaining.
 B populations I, II, III and IV represent four different species.
 C if population II and IV were to die out, there would be two different species remaining.
 D if population III were to die out, there would be only one species remaining.
- 1.1.6 Which of the following is the best definition of a species?
- A A population of similar animals which can interbreed
 B A population of organisms which breed to produce fertile offspring
 C A community of organisms which can interbreed
 D A population of organisms with similar characteristics
- 1.1.7 The table below shows the number of differences in the amino acid sequence of the protein albumin in four species of primates.

Species of primates	Monkey	Gibbon	Gorilla	Human
Human	32	14	8	0
Gorilla	32	14	0	
Gibbon	32	0		
Monkey	0			

Which two species are likely to have separated most recently, according to the results on the table?

- A Humans and monkeys
 B Gorillas and gibbons
 C Gibbons and monkeys
 D Gorillas and humans

Example examination papers

- 1.1.8 The diagram below shows the changes in cell mass and DNA mass during two cell cycles.

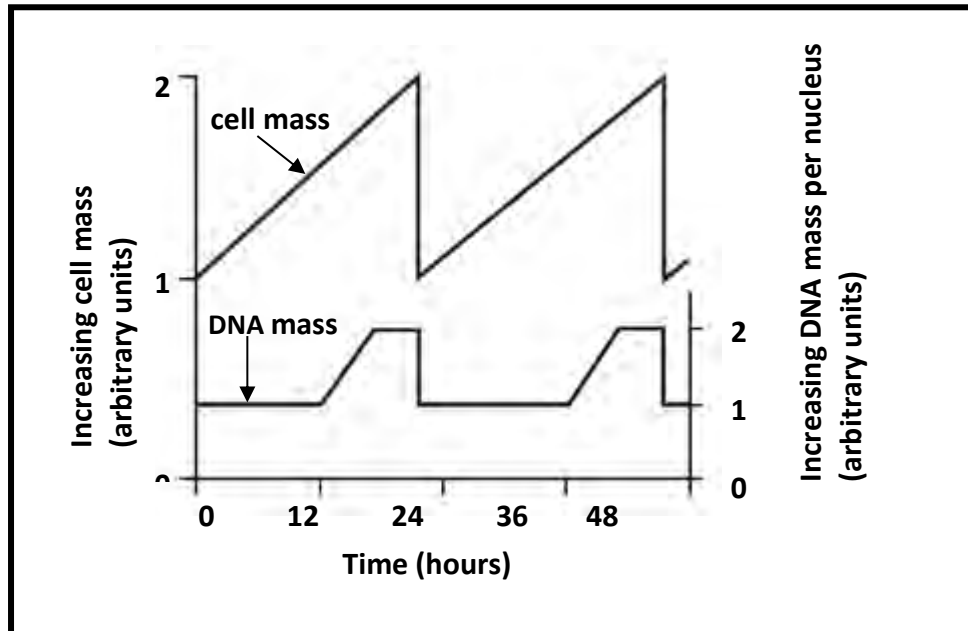

It can be concluded from the graph that during the cell cycle ...

- A interphase is the longest phase.
 - B the cell is dividing between 24 and 36 hours.
 - C replication takes place between 0 and 12 hours.
 - D cytokinesis takes place at 12 and 36 hours.
- 1.1.9 From the cladogram below which statement is correct about the relations amongst A, B, C and D?

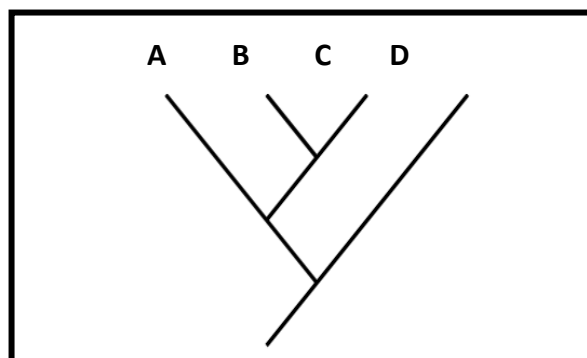

- A B and C are the most closely related.
- B A is more closely related to B than to C.
- C A and B are the most closely related.
- D A and B are the least related.

Example examination papers

1.1.10 Which of the following statements are characteristic of DNA?

- (i) Double-stranded helix
- (ii) Sugar molecule is deoxyribose
- (iii) Found in the nucleus
- (iv) Constant amount normally found in all the somatic cells of a particular species

- A (i), (ii) and (iii) only
- B (i), (ii) and (iv) only
- C (i), (iii) and (iv) only
- D (i), (ii), (iii) and (iv)

(10 x 2) (20)

1.2 Give the correct **biological term** for each of the following descriptions. Write only the term next to the question number (1.2.1 to 1.2.10) in your ANSWER BOOK.

- 1.2.1 The point at which two chromatids of a chromosome are joined together.
- 1.2.2 The process by which the DNA molecule makes a copy of itself.
- 1.2.3 Two identical alleles for a particular characteristic.
- 1.2.4 Organisms that have the same alleles at a given locus.
- 1.2.5 The stage in the process of formation of a protein determined by the anticodons in the tRNA.
- 1.2.6 Abnormal meiosis leading to Down's syndrome.
- 1.2.7 Examples of the types of inheritance are skin, colour and height.
- 1.2.8 The number, shape and arrangement of all the chromosomes in the nucleus of a somatic cell.
- 1.2.9 The physical and functional expression of a gene.
- 1.2.10 An allele that is not expressed when found in the heterozygous condition.

(10)

1.3 Indicate whether each of the statements in COLUMN I applies to **A only**, **B only**, **both A and B** or **NONE** of the items in COLUMN II. Write **A only**, **B only**, **both A and B**, or **NONE** next to the question number (1.3.1 to 1.3.7) in your ANSWER BOOK.

Example examination papers

	COLUMN I	COLUMN II
1.3.1	The study of ancient humans and their cultural activities	A: Palaeontology B: Anthropology
1.3.2	Change in the genetic make-up of an organism	A: Mutation B: Multiple alleles
1.3.3	The development of organisms over many generations to achieve the most desirable phenotype to survive	A: Natural selection B: Artificial selection
1.3.4	Introduces variation within a species	A: Crossing over during meiosis B: Random assortment of chromosomes during meiosis
1.3.5	Characteristic that is used to build a phylogenetic tree	A: Similarity of DNA sequence B: Biogeography
1.3.6	Results when a diploid cell divides during meiosis	A: Four diploid cells B: Four haploid cells
1.3.7	A genetic disorder that is caused by a chromosomal aberration	A: Haemophilia B: Albinism

(7 x 2) (14)

- 1.4 The graph below shows the results of an investigation into the frequency of blood groups in a small human population.

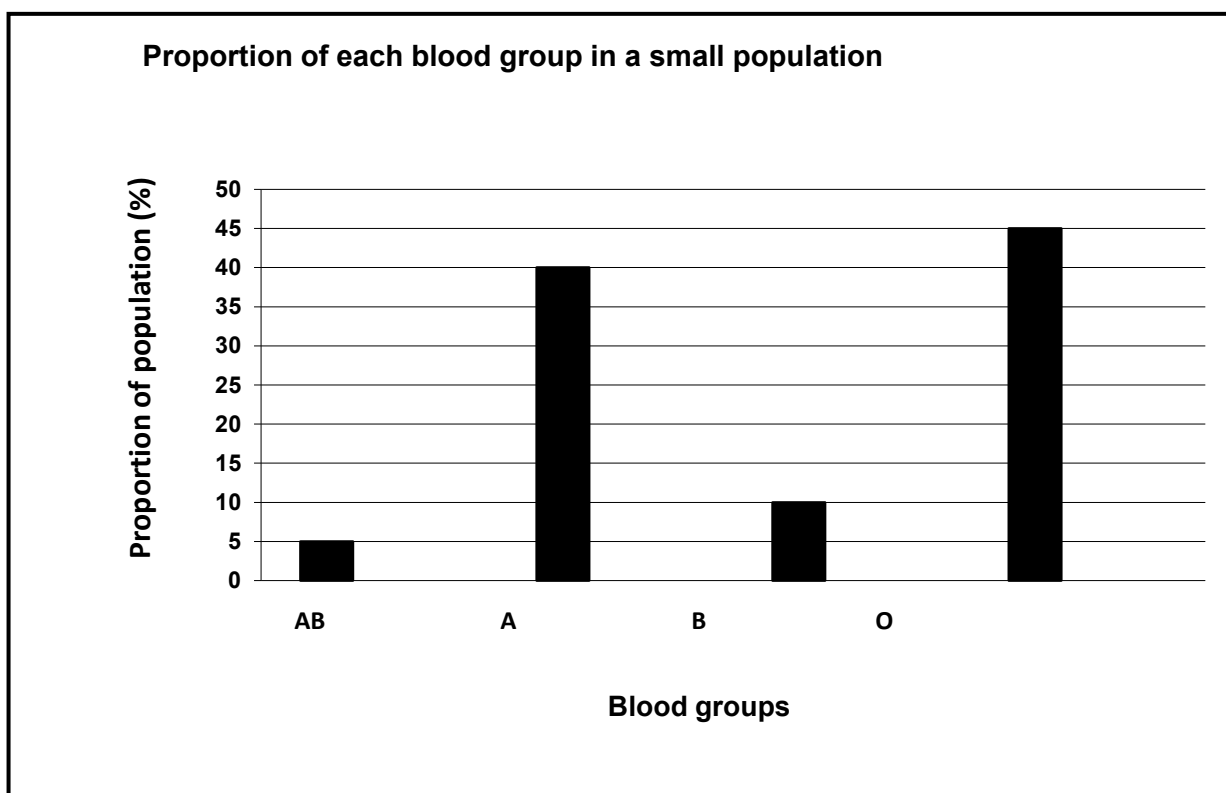

Example examination papers

- | | | |
|-------|---|------------|
| 1.4.1 | How many alleles control the blood groups? | (1) |
| 1.4.2 | Which blood group has the lowest frequency in the population? | (1) |
| 1.4.3 | Write down the genotype of blood group O. | (1) |
| 1.4.4 | Write down the genotype of blood group A. | (1) |
| 1.4.5 | State one reason why it is suitable for the results of this investigation to be presented in the above type of graph. | (2)
(6) |

TOTAL QUESTION 1: 50
TOTAL SECTION A: 50

Example examination papers

SECTION B

QUESTION 2

2.1 Study the diagram below illustrating protein synthesis and answer the questions that follow.

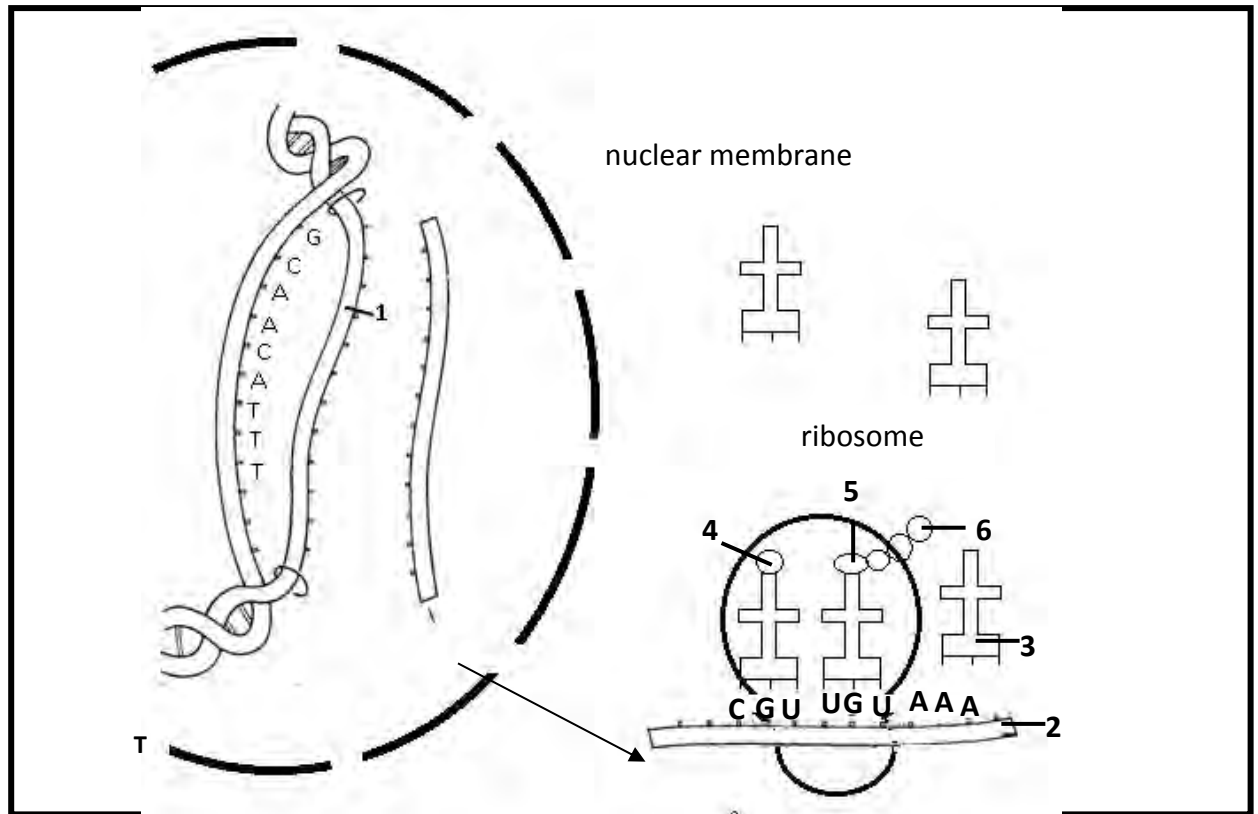

- 2.1.1 Name the molecule labelled 2. (1)
- 2.1.2 Using the letters of the genetic code, write down the complementary nitrogenous bases on strand 1 of the DNA double helix, starting from the top. (2)
- 2.1.3 The table below shows the base triplets of tRNA (anticodons) that correspond to the different amino acids.

Example examination papers

Base triplets (anticodons) of tRNA that correspond to different amino acids	
tRNA anticodons	amino acids
UGU	threonine
CGU	alanine
UUU	lysine
ACA	cysteine
GCA	arginine
GUU	glutamine
CUA	aspartate
CCA	glycine
AAA	phenylalanine

Use the diagram in QUESTION 2.1 and the table provided to...

- (a) write down the anticodon at 3. (1)
- (b) name the amino acid at 5. (1)
- (c) state how the composition of the protein molecule would change if the base sequence of the first codon (from the left) of molecule 2 was UUU instead of CGU. (2)
- (7)

2.2 Two investigators, Jacky and Lindi, carried out separate investigations about the variation in the height of sunflower plants that were planted in a field on 10 September 2012.

Jacky's procedure was as follows:

- Investigation was done on the 20 October 2012
- The sunflower plants were taken from 20 randomly selected areas
- The sunflower plants that were measured were selected at random
- The heights of 10 plants were measured in each of the selected areas.

Lindi's procedure was as follows:

- Investigation was done on the 24 October 2012
- The sunflower plants were taken from 20 randomly selected areas
- The sunflower plants that were measured were selected at random
- The heights of 5 plants were measured in each of the selected areas

The results of both Jacky's and Lindi's investigations are shown in the table below.

Example examination papers

Height interval (cm)	Number of sunflower plants	
	Jacky	Lindi
51 – 55	25	15
56 – 60	45	20
61 – 70	40	30
71 – 75	55	25
76 – 80	35	10

- 2.2.1 Explain why the plants were selected at random. (2)
- 2.2.2 Jacky concluded that the variation in height of sunflower plants is only due to genetics. Explain why this conclusion is probably wrong. (2)
- 2.2.3 Whose results are probably more reliable? (1)
- 2.2.4 Give a reason for your answer in QUESTION 2.2.3. (1)
- 2.2.5 State TWO ways in which the design of the investigation may be improved, to increase validity or reliability of the procedure. (2)
- 2.2.6 Draw a histogram to illustrate Jacky's results. (6)
- (14)**

2.3 Study the diagrams representing various phases in meiosis in an organism.

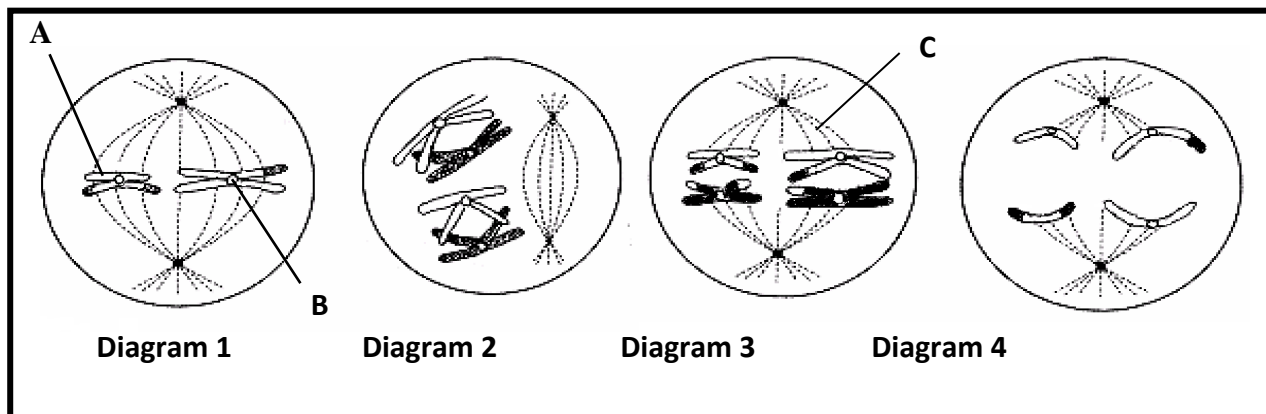

- 2.3.1 Which diagram/s 1 to 4 represents meiosis II? (2)
- 2.3.2 Suggest why the chromosomes in diagram 2 will be genetically different from those of the parent cell at the beginning of meiosis. (3)
- 2.3.3 How many chromosomes will each daughter cell have at the end of this cell division? (1)
- 2.3.4 State TWO reasons why this type of cell division is important. (2)

Example examination papers

2.3.5 Write down the numbers of the diagrams to show the correct sequence in which the phases occur.

(1)
(9)

2.4 The pedigree diagram below traces the inheritance of vestigial (reduced in size) and normal wing trait in fruit flies. Study it and answer the questions.

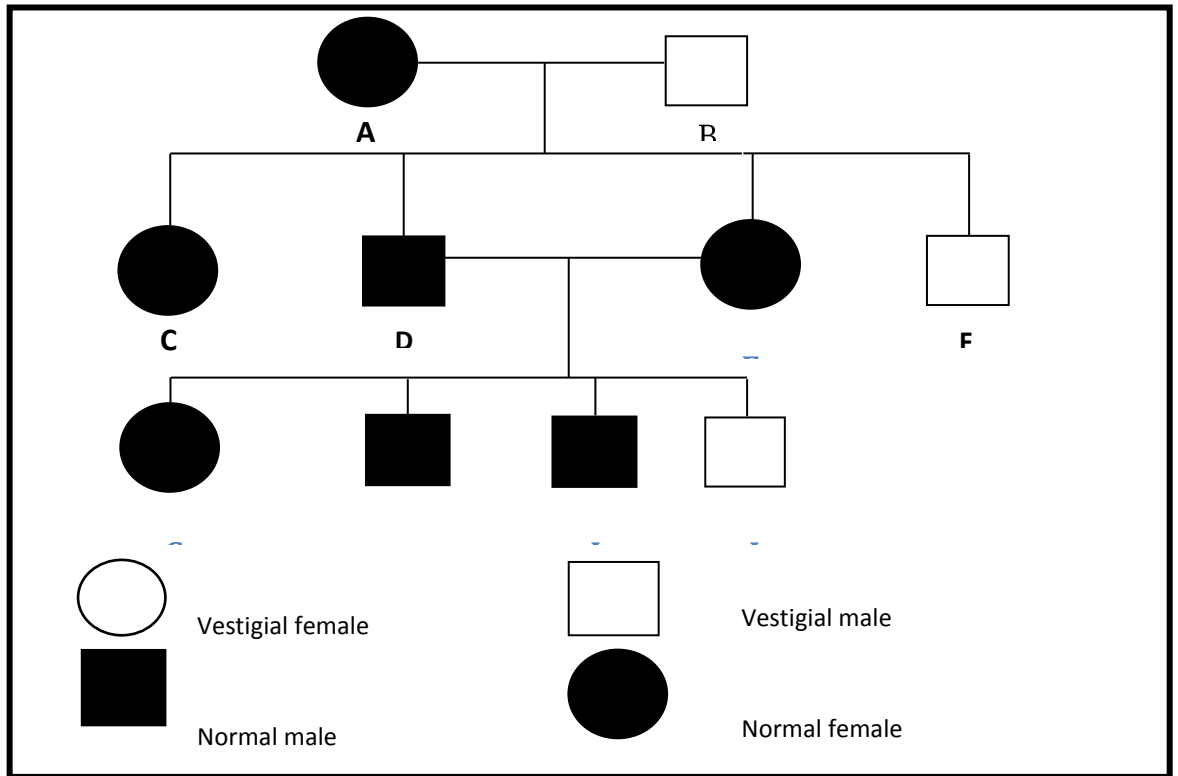

2.4.1 State the dominant wing characteristic of the flies used in these crosses.

(1)

2.4.2 Using the letters **G** and **g**, write down the genotype of:

- (a) A
- (b) J

(1)
(1)

2.4.3 Show, with a genetic cross, the offspring when fly C was crossed with a male having vestigial wings.

(7)
(10)

TOTAL QUESTION 2: 40

Example examination papers

QUESTION 3

- 3.1 In mosquitoes there is a gene locus which has alleles involved in resistance to DDT, a well known insecticide.

The graph below shows the number of mosquitoes and their genotypes, collected from 1965 when DDT was first used, through to 1970, two years after the spraying of DDT stopped.

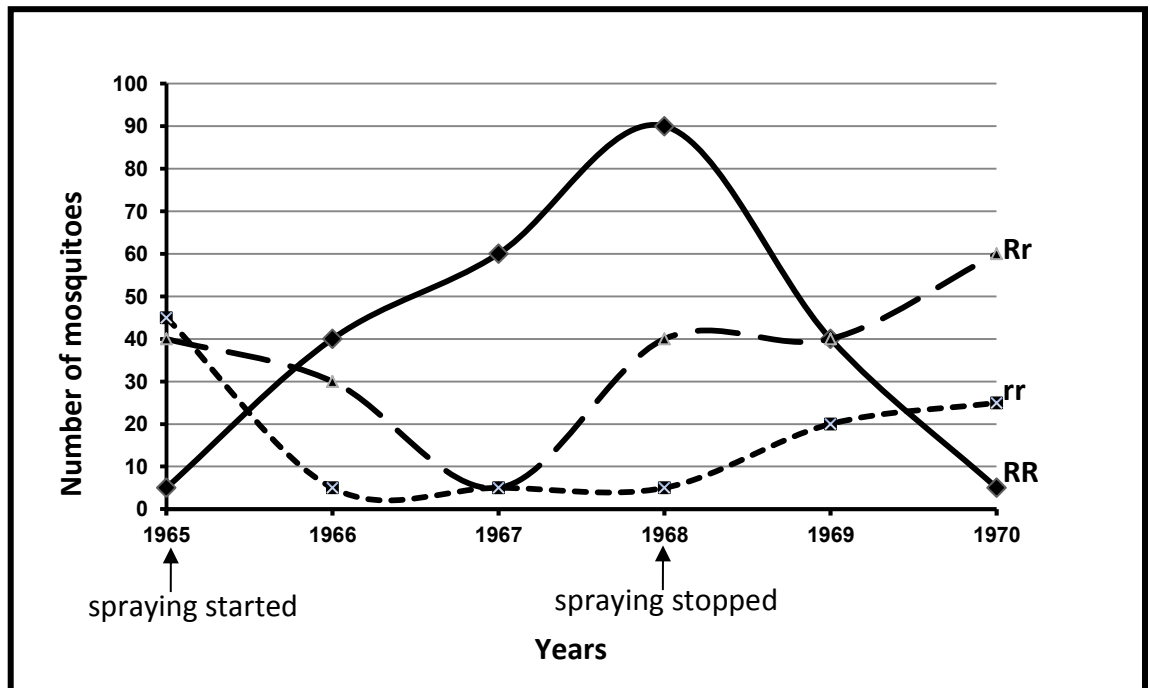

- 3.1.1 How many alleles are involved in the trait for resistance in mosquitoes? (1)
- 3.1.2 State the genotype for the recessive mosquitoes. (1)
- 3.1.3 Which genotype appeared more frequently in the population in 1970? (1)
- 3.1.4 Which genotype had its chances of survival reduced after the removal of DDT in 1968? (1)
(4)

Example examination papers

3.2 The diagram below represents a karyotype of a human cell.

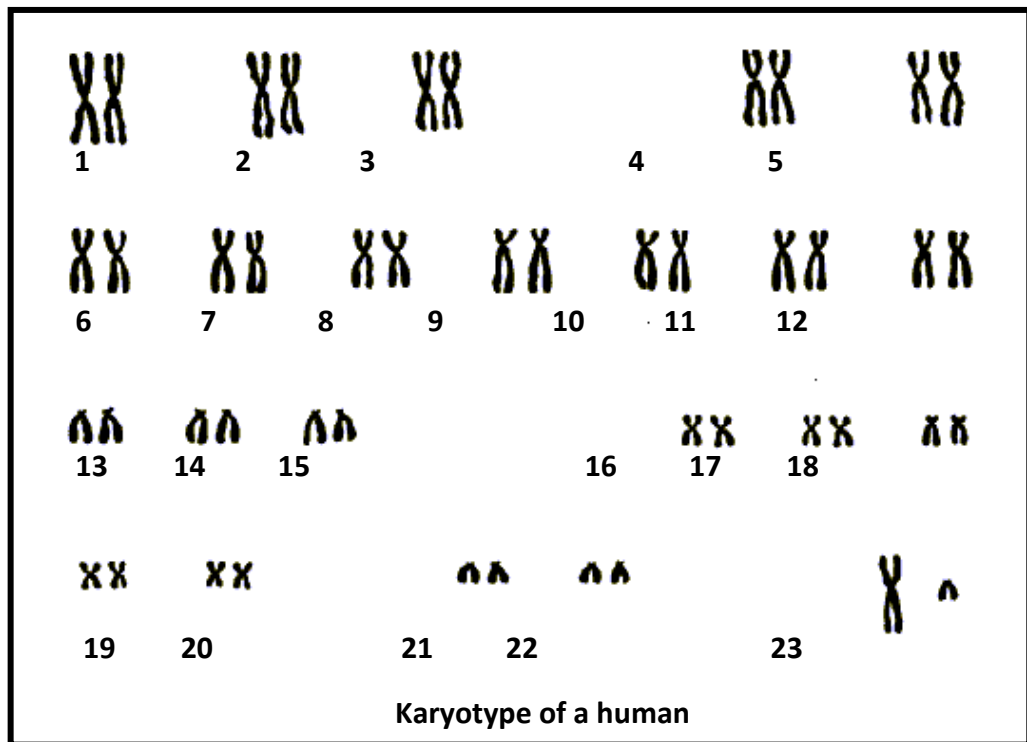

- 3.2.1 How many chromosomes are present in this karyotype? (1)
- 3.2.2 Is this karyotype that of a man or a woman? (1)
- 3.2.3 Give a reason for your answer in QUESTION 3.2.2. (2)
- 3.2.4 State how the karyotype of a person with Down's syndrome would be different from that of the karyotype shown in the diagram above. (2)
- (6)**

3.3 Study the table below which indicates some of the hominid fossils found in the world, and answer the questions which follow.

Example examination papers

Species	Region found	Period of existence (when lived)
<i>Australopithecus afarensis</i>	Eastern Africa	3,4 – 2,8 mya
<i>Australopithecus africanus</i>	Southern Africa	2,1 – 2,8 mya
<i>Australopithecus sediba</i>	Southern Africa	2,0 – 1,9 mya
<i>Homo habilis</i>	Sub-Saharan (Africa)	2,3 – 1,4 mya
<i>Homo erectus</i>	Africa, Europe, Asia	1,5 – 0,2 mya
<i>Homo heidelbergensis</i>	Europe, China	0,6 – 0,35 mya
<i>Homo neanderthalensis</i>	Europe, Western Asia	0,35 – 0,03 mya
<i>Homo sapiens</i>	Worldwide	0,2 mya – present

(Adapted from *The Evolutionary Road*, Jamie Shreeve, National Geographic, July 2010)

- 3.3.1 Explain why the information in the table supports the 'Out of Africa' hypothesis. (5)
- 3.3.2 If a fossil of *Australopithecus afarensis* dated 3,2 mya is found in Asia, explain the implications for the 'Out of Africa' hypothesis. (2)
- 3.3.3 List TWO fossils found in:
 (a) The Rift valley (2)
 (b) South Africa (2)
- 3.3.4 Describe TWO genetic lines of evidence that support the 'Out of Africa' hypothesis. (6)
- 3.3.5 Describe the significance of *Australopithecus sediba* as a transitional fossil. (3)
- 3.3.6 List two other forms of evidence for human evolution that is studied by anthropologists. (2)

- 3.4 Study the three diagrams (A, B and C) below that show how populations of beetles changed over a long period of time. (22)

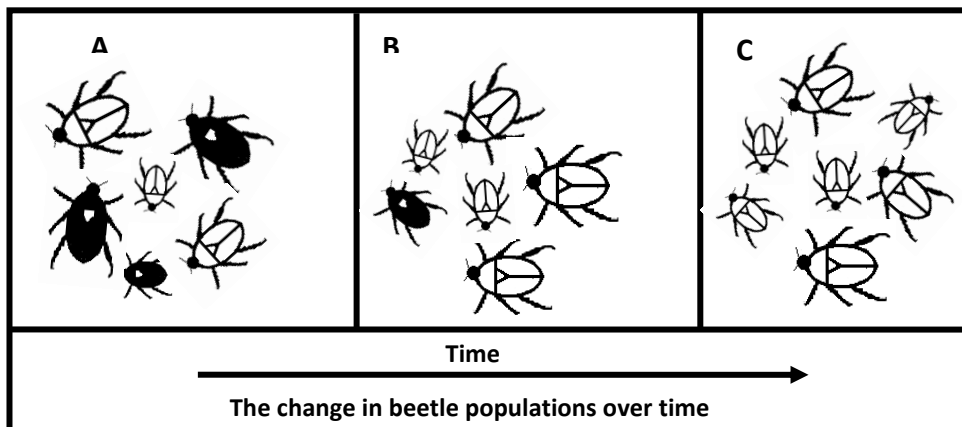

Example examination papers

- 3.4.1 From a comparison of pictures A and B, state the characteristic of the beetles that have enabled their offspring to survive. (1)
- 3.4.2 Name the mechanism that is illustrated in these diagrams. (1)
- 3.4.3 Use the three diagrams above to explain the mechanism mentioned in QUESTION 3.4.2. (6)
(8)

TOTAL QUESTION 3: 40

TOTAL SECTION B: 80

Question 4

- 4.1 Describe the anatomical similarities and facial differences between African apes and humans, that are used as evidence of common ancestors between living hominids.

(20)

TOTAL SECTION C: 20

GRAND TOTAL: 150

Answers to exam paper 1

SECTION A

QUESTION 1

1.1	1.1.1	B✓✓		
	1.1.2	A✓✓		
	1.1.3	B✓✓		
	1.1.4	A✓✓		
	1.1.5	C✓✓		
	1.1.6	D✓✓		
	1.1.7	C✓✓		
	1.1.8	B✓✓		
	1.1.9	A✓✓		
	1.1.10	B✓✓		
			(10 x 2)	(20)
1.2	1.2.1	Internal fertilisation✓		
	1.2.2	Endocrine system✓		
	1.2.3	Hypothalamus✓		
	1.2.4	Pituitary gland/Hypophysis✓		
	1.2.5	Hypothermia✓		
	1.2.6	Phototropism ✓		
	1.2.7	Carbon footprint✓		
	1.2.8	Desertification✓	(8 x 1)	(8)
1.3	1.3.1	B only✓✓		
	1.3.2	A only✓✓		
	1.3.3	A only✓✓		
	1.3.4	A only ✓✓		
	1.3.5	Both A and B✓✓		
			(5 x 2)	(10)
1.4	1.4.1	(a) G✓		(1)
		(b) A✓		(1)
		(c) D✓		(1)
		(d) G✓		(1)
		(e) B✓		(1)
		Kidney ✓		(5)
1.5	1.5.1	(a) Adrenal gland✓		(1)

Answers to examination papers

- 1.5.2 (b) Aldosterone✓ (1)
(1)
- 1.5.3 The adrenal cortex secretes more aldosterone✓. Therefore more sodium✓ is reabsorbed by the blood capillaries✓ at the distal✓ and collecting tubules✓ and less sodium ions are excreted. ✓ (1)
(any 4) (4)
(7)

TOTAL SECTION A: 50

SECTION B

QUESTION 2

- 2.1 2.1.1 Metaphase 1✓. The chromosomes are lined up at the equator of the cell in their homologous pairs✓.
OR
The chromosomes show evidence of crossing over✓. (2)
- 2.1.2 Two✓ (1)
- 2.1.3 The next phase is Anaphase 1. The spindle fibres contract✓ (shorten) and pull each chromosome✓ of each chromosome pair to opposite poles✓ of the cell. (3)
- 2.1.4 **Homologous pair of chromosomes**

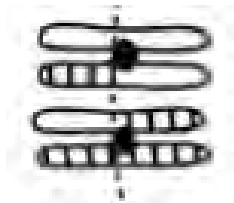

- ✓ = heading
✓✓ = any 2 correct labels
(chromatid, centromere) (3)
(9)

- 2.2 2.2.1 (a) Vas deferens/sperm duct✓ (1)
(b) Epididymus✓ (1)
(c) Urethra✓ (1)
- 2.2.2 (a) Secretes a fluid which promotes movement of the spermatozoa/provides nutrition to the spermatozoa ✓ (1)
(b) Secretes testosterone/ Produces sperm ✓ (1)
- 2.2.3 (a) Sterilisation✓. Semen will still be produced✓ but there will be

Answers to examination papers

- no sperm✓ in it, because the sperm cannot be transported from the testes. ✓ (any 2) (2)
- (b) Yes✓
The HI virus is carried in body fluids✓./Saliva/blood can still infect a person through open wounds✓/blood transfusion.
OR
Seminal fluids✓ will still be produced and can infect a person during sexual intercourse✓. (2)
- 2.2.4 Sperm cells are temperature sensitive✓ and must be kept at a temperature lower than body temperature✓. On a warm day they must be kept away from the body ✓ and on a cold day, close to the body, which will be warmer✓. (any 2) (2)
- (11)**
- 2.3 2.3.1 I – LH✓
II – progesterone✓ (2)
- 2.3.2 14✓ (1)
- 2.3.3 Day 0✓ – Day 7✓ (2)
- 2.3.4 FSH stimulates the development of the primary follicles to Graafian follicles✓. (1)
- 2.3.5 FSH stimulates the development of the Graafian follicles✓.
Oestrogen inhibits the production of FSH✓, so that only one follicle at a time matures. (2)
- 2.3.6 Progesterone levels decrease✓ towards the end of the cycle.
The corpus luteum decreases✓ in size. (2)
- (10)**

Answers to examination papers

2.4 2.4.1

Popularity among the various methods of family planning

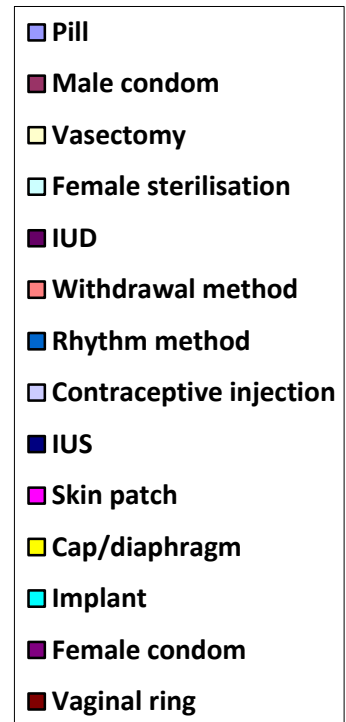
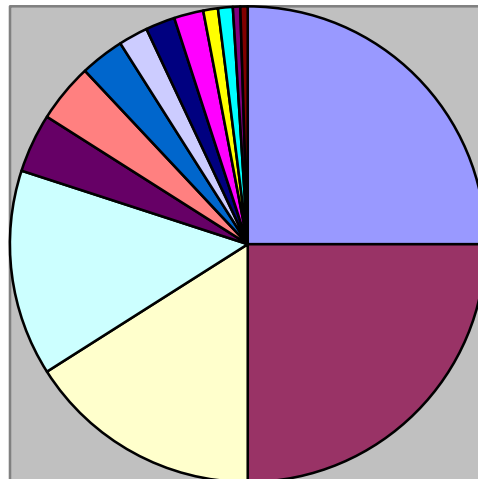

Pill:
$$\frac{25}{100} \times 360^\circ$$

= 90°

(Each sector must be calculated like this)

NOTE:

If the wrong type of graph is drawn marks will be lost for 'correct type of graph'

Rubric for the mark allocation of the graph

Correct type of graph = 1 ✓

Caption for graph = 1 ✓

Calculations shown = 1 ✓

Drawing of graph:

1– sectors drawn correctly ✓

3–4 sectors drawn correctly ✓✓

5–6 sectors drawn correctly ✓✓✓

Answers to examination papers

7–8 sectors drawn correctly ✓✓✓✓

9–10 sectors drawn correctly ✓✓✓✓✓

11–12 sectors drawn correctly ✓✓✓✓✓✓

13–14 sectors drawn correctly ✓✓✓✓✓✓✓

(10)

(10)

[40]

QUESTION 3

- | | | | |
|-----|-------|--|--------------------|
| 3.1 | 3.1.1 | <p>A – cerebrum✓
 B – cerebellum✓
 C – medulla oblongata ✓
 D – spinal cord✓</p> | (4) |
| | 3.1.2 | <p>Controls all voluntary actions✓
 Receives and interprets all sensations, that is, sight, hearing, smell, taste and touch✓
 Controls all the higher thought processes such as memory, judgement, reasoning, etc✓</p> <p style="text-align: right;">(any 2)</p> | (2) |
| | 3.1.3 | <p>Memory loss✓
 Confusion✓</p> | (2) |
| | 3.1.4 | <p>It affects the parts of the brain than control emotions, memory, and judgement✓.
 It can weaken short term memory and can block information from becoming saved into long term memory✓.
 It weakens problem-solving ability✓.</p> <p style="text-align: right;">(first 2)</p> | (2)
(10) |
| 3.2 | 3.2.1 | Adrenalin✓ | (1) |
| | 3.2.2 | On top of kidney✓ | (1) |
| | 3.2.3 | Pupil✓ | (1) |
| 3.3 | 3.3.1 | Herbivores eat plants✓. The plant protects itself against being eaten✓. | (3) |
| | 3.3.2 | <ul style="list-style-type: none"> • Learn to identify the plant ✓. • Find volunteers✓. | (2) |

Answers to examination papers

- Determine the size of the experiment (how many people) ✓.
- Determine the method of testing ✓.
- Decide on a way to record the data ✓.

(5)

Use more people in the investigation ✓.

3.3.3

(1)

3.4

3.4.1

Rhinoceros hunted from 2007 to 2010

(8)

Year	Number of rhinoceros
2007	13
2008	83
2009	122
2010	287

Caption ✓

Labelled all rows correctly ✓

Labelled both columns correctly ✓

Drawing of table ✓

For each correct number ✓✓✓✓

(8)

3.4.2

Rhinoceros hunting ✓ increased from 2007 to 2010 ✓

(2)

Number of rhinoceros hunted ✓

3.4.3

(1)

Years ✓

3.4.4

(1)

3.5

3.5.1

Freshwater irrigated:

Seawater irrigated:

$$2 + 1,1$$

$$1,75 + 1,75$$

$$= 3.1/\text{kg m}^{-2} \text{ y}^{-1} \quad \checkmark$$

$$= 3.5 /\text{kg m}^{-2} \text{ y}^{-1} \quad \checkmark$$

The biomass yield is almost the same ✓

(3)

(2)

3.5.2

Daily weight gain is more ✓ in sheep fed on sea blite ✓.

3.5.3

Water intake is higher ✓ and food conversion efficiency is slightly lower ✓.

(2)

(7)

[40]

TOTAL SECTION B: 80

Answers to examination papers

SECTION C

QUESTION 4

4.1 Sample answer

Hearing

- Sound waves are directed into the auditory canal✓ by the pinna✓.
- The sound waves make the tympanic membrane vibrate✓ and the vibrations are passed on to the ossicles✓ in the middle ear.
- The ossicles make the oval window vibrate✓ and this causes pressure waves✓ to be set up in the inner ear.
- These vibrations also cause the organ of Corti✓ to be stimulated and it generates impulses✓ which are sent to the cerebrum✓ along the auditory nerve✓.
- The cerebrum interprets the impulses as sound✓.

Balance

- Sudden changes in speed and direction✓ causes the endolymph✓ within the semicircular canals to move.
- The movement of the fluid stimulates the cristae✓ in the ampullae – situated at the base of the semi circular canal. ✓
- When the direction of the head changes, gravitational pull stimulates maculae✓ – in the sacculus✓ and utriculus✓
- Within the cristae and maculae the stimuli are converted to impulses✓.
- These impulses are sent to the brain✓ by the vestibular branch✓ of the auditory nerve.

(any 17)

ASSESSING THE PRESENTATION OF THE ESSAY

Marks	Description	
3	Explained all hearing and balance fully without irrelevant information.	
2	Explained hearing and balance competently with little/no irrelevant information.	
1	Explained one of hearing or balance fully with little/no irrelevant information.	
0	Not attempted/nothing written other than question number/no correct information.	
		Synthesis (3)
		(20)
		TOTAL SECTION C: 20
		GRAND TOTAL: 150

Answers to exam paper 2

SECTION A

QUESTION 1

1.1	1.1.1	A✓✓		
	1.1.2	B✓✓		
	1.1.3	D ✓✓		
	1.1.4	C✓✓		
	1.1.5	A✓✓		
	1.1.6	B✓✓		
	1.1.7	B✓✓		
	1.1.8	A✓✓		
	1.1.9	A✓✓		
	1.1.10	D✓✓	(10 x 2)	(20)
1.2	1.2.1	Chiasmata✓		
	1.2.2	Replication✓		
	1.2.3	Homologous ✓		
	1.2.4	Homozygous ✓		
	1.2.5	Translation✓		
	1.2.6	Non disjunction✓		
	1.2.7	Polygenic✓		
	1.2.8	Karyotype✓		
	1.2.9	Phenotypic✓		
	1.2.10	Recessive allele✓		(10)
1.3	1.3.1	B only✓✓		
	1.3.2	A only ✓✓		
	1.3.3	A only ✓✓		
	1.3.4	Both A and B ✓✓		
	1.3.5	A only✓✓		
	1.3.6	B only✓✓		
	1.3.7	Both A and B ✓✓	(7 x 2)	(14)
1.4	1.4.1	3✓		(1)
	1.4.2	AB✓		(1)
	1.4.3	i✓		
	1.4.4	I ^A I ^B ✓✓/ I ^A i		(1)

Answers to examination papers

1.4.5 A column graph shows the percentages of each type of blood group separately✓. (2)

(1)
(7)

TOTAL QUESTION 1: 50

TOTAL SECTION A: 50

SECTION B

QUESTION 2

2.1.1 mRNA ✓ (1)

2.1.2 (CGT TGT AAA)✓✓ (2)

2.1.3

(a) UUU ✓✓ (1)

(b) cysteine✓✓ (1)

(c) The protein would have the amino acid phenylalanine✓ instead of arginine✓ leading to a different protein✓. any (2)

(7)

2.2

2.2.1 This increases the chances✓ of the sample being representative✓ of the plant population. (2)

2.2.2 Other factors like environmental factors✓/amount of light/soil type will also influence✓ the height to which sunflower plants grow. Genetic variation is only one of many factors✓ that influences the height/genotype tends to represent the potential✓ and environment actualises✓ the potential. any (2)

2.2.3 Jacky✓ (1)

2.2.4 Jacky included a larger number✓/10 of plants in the sample/bigger sample size (1)

2.2.5 The number of plants measured in each sample for both must be the same. ✓

- Measurements must be done at the same time✓
- Measurements must be done on the same day✓
- Increase the sample size in each of the selected areas✓
- Repeat the investigation✓ (any 2) (2)

Answers to examination papers

2.2.6

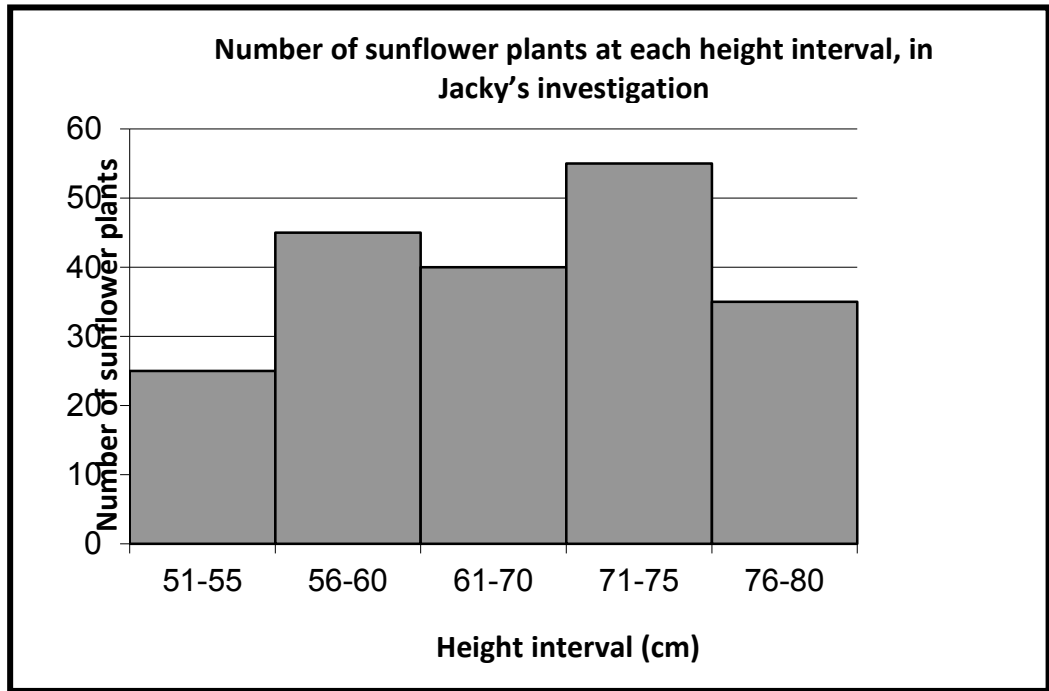

Mark allocation of the graph

Correct type of graph	✓
Title of graph	✓
Correct label and appropriate scale for X-axis including units	1
Correct label for and Appropriate scale Y-axis	✓
Drawing of bars	✓ 1–4 bars drawn correctly ✓✓ All 5 bars drawn correctly

(6)

NOTE:

If the wrong type of graph is drawn:

- Marks to be lost for 'correct type of graph'

If axes are transposed:

- Marks to be lost for labelling of X-axis and Y-axis

(14)

2.3

2.3.1 Diagrams 1✓ and 4✓ (2)

2.3.2 Because of crossing over✓ pieces of chromatids/groups of genes✓ are exchanged✓ between the homologous chromosomes✓ (one from mother and one from father) (3)

2.3.3 2✓

(1)

Answers to examination papers

2.3.4 Reduction of chromosome number from diploid to haploid✓
 Production of gametes✓
 Mechanism to introduce genetic variation through crossing over and
 random assortment of chromosomes✓ (any 2) (2)

2.3.5 2,3,1,4 (1)
(9)

2.4 2.4.1 Normal✓ wings (1)

2.4.2 (a) **Gg**✓ (1)

(b) **gg**✓ (1)

2.4.3 Gg✓✓ (2)

gg✓✓ (any order) (2)

(7)

2.4.4

P₁/parent phenotype normal female x vestigial wings male✓
 genotype Gg x gg✓

Meiosis

G/gametes G, g x g, g✓

Fertilisation

OR

Gametes	G	g
g	Gg	gg
g	Gg	gg

1 mark for correct gametes

1 mark for correct genotypes

F₁/offspring genotype Gg, Gg, gg, gg✓

phenotype 2 normal wings and 2 vestigial wings✓

Parents and offspring✓/P₁ and F₁

Meiosis and fertilisation✓ any (7)

Answers to examination papers

			(10)
		TOTAL QUESTION 2	40
QUESTION 3			
3.1	3.1.1	2✓	
	3.1.2	rr✓	
	3.1.3	Rr✓/ heterozygous	
	3.1.4		(3)
		RR✓/ homozygous dominant	(1)
	3.2.1		(1)
	3.2.2		(4)
	3.2.3	46✓/23 pairs	
		Man✓	
3.2	3.2.4	One✓ large chromosome✓ /one big and one small chromosome/ chromosomes of pair 23 are different	(1)
		A person with Down's syndrome will have 3✓ copies of chromosome number 21✓ in each cell instead of 2.	(1)
			(2)
			(2)
			(6)
3.3.1	The oldest fossils ✓ of hominids (Australopithecines and <i>Homo habilis</i>) are only found in Africa✓, whilst the younger fossils are found worldwide✓ which suggests that humans originated in Africa. The oldest <i>Homo erectus</i> fossils✓ was found in Africa and later in Europe and Asia, which suggests that <i>Homo erectus</i> migrated✓ out of Africa (any 5)		(5)
3.3.2	The hypothesis ✓ will be rejected✓; it would imply that the origin of humans is in Asia✓ not Africa		(2)
3.3.3	(a)	Nutcracker man, (<i>Paranthropus boisei</i>) ✓ Handy man, (<i>Homo habilis</i>) ✓ Laetoli footprints, ✓ Toumai. (<i>Sahelanthropus tchadensis</i>) ✓	(any 2) (2)
	(b)	Mrs Ples (<i>Australopithecus africanus</i>) ✓ Taung child, (<i>Australopithecus africanus</i>), ✓ Karabo (<i>Australopithecus sediba</i>) ✓	(any 2) (2)
3.3.4	Mutations in mitochondrial DNA (mtDNA)✓ can be used to trace the female✓ ancestral line as mitochondria DNA is only inherited from your mother✓; this has been traced to a female ancestor in Africa.		(3)

Answers to examination papers

- Mutations in the Y-chromosome✓ can be use to trace the partenal✓ (male) ancestral line because only males inherit the Y-chromosome from their father✓ and this can be traced to a male ancestor in Africa. (3)
- 3.3.5 A transitional form has characteristics✓ of both the australopithecines✓ and humans✓. (3)
- 3.3.6 Tool making✓
Rock painting✓ (2)
- (22)
- 3.4
- 3.4.1..Colour of the beetle✓ (1)
- 3.4.2 Natural selection✓/survival of the fittest (1)
- 3.4.3 There is variation✓ in the colour of the beetles /black and white/light colour
The white/light colour beetles have the desirable characteristic✓/are better adapted/ to camouflage/ better coloured for surviving.
More of the white/light coloured beetles survive✓ and reproduce white/light coloured offspring✓.
More of the black beetles died✓/ were eaten by the predators.
Over generations all beetles will be white/light coloured ✓. (6)
(8)

TOTAL QUESTION 3: 40
TOTAL SECTION B: 80

Answers to examination papers

SECTION C QUESTION 4

4.1 Characteristics humans share with African apes

- Upright posture
- Large brains/skulls compared to their body mass
- Long upper arms
- Eyes in front/binocular vision/stereoscopic vision
- Eyes with cones/colour vision
- Two mammary glands only
- Freely rotating arms
- Elbow joints allowing rotation of forearm
- Flat nails instead of claws/bare finger tips
- Opposable thumbs which work in opposite direction to their fingers
- Sexual dimorphism/distinct differences between male and female
- Rotate hands at least 180°
- Olfactory brain centers reduced/reduced sense of smell
- Parts of the brain that process information
- from the hands and eyes are enlarged (max) 10

Characteristics that make humans different from African apes

- Brain case size and shape are different
 - Shape and slope of forehead
 - Brow ridge development
 - The facial angle
 - Size of canines
 - Position of foramen magnum
 - Degree of prognathism
 - Presence of a chin
 - Gap between incisors and canines (max) 7
- Content (17)
Synthesis (3)
(20)

ASSESSING THE PRESENTATION OF THE ESSAY	
Marks	Description
3	Well structured – demonstrates insight and understanding of question.
2	Minor gaps or irrelevant information in the logic and flow of the answers.
1	Attempted but with significant gaps and irrelevant information in the logic and flow of the answers.
0	Not attempted/nothing written other than question number/no correct information.

TOTAL SECTION C: 20
GRAND TOTAL: 150