

SA's Leading Past Year

Exam Paper Portal

STUDY

You have Downloaded, yet Another Great Resource to assist you with your Studies 😊

Thank You for Supporting SA Exam Papers

Your Leading Past Year Exam Paper Resource Portal

Visit us @ [www.saexampapers.co.za](http://www.saexampapers.co.za)



SA EXAM  
PAPERS

# Study Guide

## Via Afrika Mathematical Literacy

### Grade 12

**(To be used in conjunction with the Via Afrika Grade 12 Mathematical  
Literacy Learner's Book and Teacher's Guide)**



ISBN: 978-1-41546-332-1



# Contents

Part 1	Content analysis .....	2
CHAPTER 1	MEASUREMENT (CONVERSIONS, TIME) .....	2
Section 1	Conversions .....	2
Section 2	Working with travel timetables and tide tables .....	5
CHAPTER 2	FINANCE (TARIFF SYSTEMS AND BREAK-EVEN, INCOME AND EXPENDITURE, COST AND SELLING PRICE) .....	10
Section 1	Tariff systems and break-even analysis .....	10
Section 2	Income-and-expenditure statements and budgets .....	15
Section 3	Running a small business .....	17
CHAPTER 3	DATA HANDLING .....	29
Section 1	Making sense of national and global statistics .....	29
Section 2	Summarising data using quartile and percentile values and interpreting box-and-whisker diagrams .....	30
Section 3	Develop opposing arguments using the same summarised and/or represented data .....	38
CHAPTER 4	FINANCE (INTEREST, BANKING, INFLATION) .....	47
Section 1	Interest and banking: loans and investments .....	47
Section 2	Inflation .....	54
CHAPTER 5	MAP AND PLANS (SCALE AND MAP WORK) .....	62
Section 1	Comparing travel options .....	62
Section 2	Compass directions .....	66
Section 3	Scale .....	67
CHAPTER 6	MEASUREMENT (MEASURING AND CALCULATING LENGTHS, PERIMETER, AREA AND VOLUME) .....	73
Section 1	Measuring .....	73
Section 2	Calculating perimeter, area and volume .....	76
CHAPTER 7	MEASUREMENT (MEASURING WEIGHT: BMI, MEDICINE DOSAGES) ....	89
Section 1	BMI growth charts for children .....	89
Section 2	Using formulae to determine medicine dosage .....	92
CHAPTER 8	FINANCE (INCOME TAX) .....	98
Section 1	Understanding taxation .....	98
Section 2	Determining income tax .....	100
Section 3	IRP5 tax forms .....	104

CHAPTER 9	FINANCE (EXCHANGE RATES) .....	109
Section 1	Ways of working with exchange rates and currency conversions .....	109
Section 2	Buying and selling currency .....	111
CHAPTER 10	MAPS AND PLANS (PLANS AND SCALE) .....	120
Section 1	Interpreting plans .....	120
Section 2	Determining scales .....	120
CHAPTER 11	PROBABILITY .....	126
Section 1	Probability theory for understanding the Lottery .....	126
Section 2	Prediction .....	130
Section 3	Expressions of probability in the press .....	133
CHAPTER 12	MAPS AND PLANS (MODELS) .....	139
Section 1	Creating a 3-D model .....	139
Part 2	Exam analysis .....	142
REQUIRED STRUCTURE OF EXAMINATIONS .....		142
Paper 1 .....		146
Paper 1 Marking guidelines .....		156
Paper 2 .....		166
Paper 2 Marking guidelines .....		176

## Introductory note

The purpose of this study guide is to provide further explanation and consolidation of the concepts explained in the Via Afrika Grade 12 Mathematical Literacy Learner's Book. This guide is not a substitute or a replacement for the Learner's Book and should not be used in isolation of the Learner's Book. Rather, this guide aims to provide further explanation of the key concepts dealt with in each chapter in the Learner's Book and more opportunity for practice and consolidation through the inclusion of additional questions. These questions will still draw on the contexts and resources used in the Learner's Book but focus on different areas of application. This guide will also make more explicit the connection between the contents of each chapter in the Learner's Book and the curriculum as outlined in the CAPS document. In this regard the study guide will help teachers to become more familiar with the contents of the CAPS curriculum document.

The study guide is made up of *two parts*.

- Part 1 provides additional explanation of the concepts, skills and contexts discussed in the teaching/theory component of the Learner's Book. Additional questions and exercises for consolidation of the *selected* concepts, skills and contexts discussed are also included.
- Part 2 provides totally new Paper 1 and Paper 2 practice examinations with analysis. These are in addition to the ones included on pages 308-318 in the Learner's Book.



## Section 1: Conversions

---

(LB pages 18-21)

### Overview

*Conversions*, is part of the Measurement Topic. The content and specific skills associated with working with this section are drawn from pages 62-63 in the CAPS document.

As stipulated in the CAPS document, Grade 12 learners need specifically to be able to:

- convert between different systems of measurement, e.g. solid to liquid conversions, including:
  - g and/or kg to ml and/or litres
  - $\text{cm}^2$  and  $\text{m}^2$  to litres
  - $\text{mm}^3$ ,  $\text{cm}^3$  and  $\text{m}^3$  to ml and litres.
- express ratios in different formats and use them to determine missing amounts (from the Basic Skills Section).

### Contexts and integrated content

- Learners need to be able to work in the context of complex projects in both familiar and unfamiliar contexts (e.g. *determining quantities of materials needed to build an RDP house*).
- Calculations involving conversions, especially between different systems, use the concept of *rates* as found in the Basic Skills Topic on Numbers and calculations with numbers.

### 1. Calculated volume to liquid volume conversions

- In everyday life volume is expressed in litres.
- When volume is calculated it is usually in cubic units ( $\text{cm}^3$ ,  $\text{mm}^3$ ,  $\text{m}^3$ ).
- Conversions between these two formats will always be given:  
 $1 \text{ cm}^3 = 1 \text{ ml}$ ,       $1 \ell = 1\,000 \text{ ml}$ ,       $1 \text{ m}^3 = 1 \text{ kl}$

**Example**

The container alongside is roughly in the shape of a rectangular box. Therefore its volume =  $l \times b \times h$

$$= 20 \text{ cm} \times 20 \text{ cm} \times 5 \text{ cm}$$

$$= 2\,000 \text{ cm}^3$$

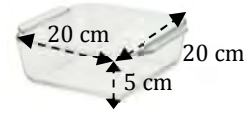

Using the conversions  $1 \text{ cm}^3 = 1 \text{ ml}$  and  $1\,000 \text{ ml} = 1 \text{ l}$ :

$$\begin{array}{ccc} \times 2 & \begin{array}{c} \curvearrowright \\ \curvearrowleft \end{array} & 1\,000 \text{ cm}^3 = 1 \text{ litre} \\ & & 2\,000 \text{ cm}^3 = \mathbf{2 \text{ litres (l)}} \end{array} \quad \begin{array}{c} \curvearrowright \\ \curvearrowleft \end{array} \times 2$$

**2. Calculated area to liquid volume conversions**

- Area is calculated in square units ( $\text{cm}^2$ ,  $\text{mm}^2$ ,  $\text{m}^2$ ).
- To calculate the volume of paint or other liquid needed to cover a surface, we use a spread rate. This tells us how much area a litre of paint (or other liquid) can cover. The spread rate will always be given (e.g.  $7 \text{ m}^2$  per litre).
- The spread rate depends on:
  - the type and thickness of the paint (or other liquid)
  - the texture (roughness) of the surface to be covered
  - how absorptive the surface to be covered is.

**Example**

A weed pesticide states that it requires 60 ml of concentrate for  $100 \text{ m}^2$  of land area. What volume of pesticide will be required to treat the area alongside?

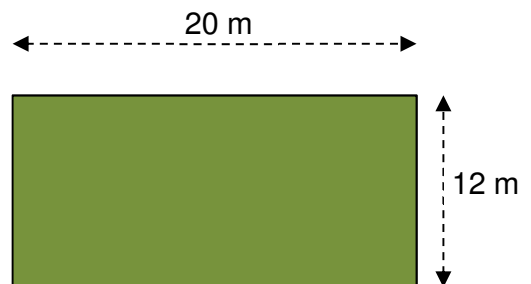

$$\begin{aligned} \text{Area} &= \text{length} \times \text{breadth} \\ &= 20 \text{ m} \times 12 \text{ m} \\ &= 240 \text{ m}^2 \end{aligned}$$

$$\begin{array}{ccc} \text{Pesticide required:} & \times 2,4 & \begin{array}{c} \curvearrowright \\ \curvearrowleft \end{array} \end{array} \quad \begin{array}{c} 60 \text{ ml} : \\ 144 \text{ ml:} \end{array} \quad \begin{array}{c} 100 \text{ m}^2 \\ 240 \text{ m}^2 \end{array} \quad \begin{array}{c} \curvearrowright \\ \curvearrowleft \end{array} \quad \times 2,4 (\div 100 \times 240)$$



### 3. Other useful building conversions

- The ratios are always given. They can be given in two ways:

Visually:

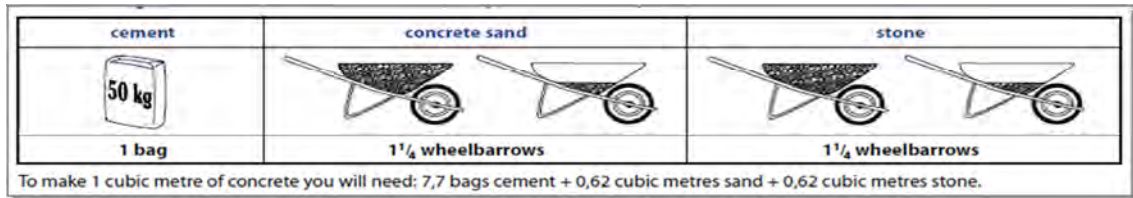

or, in a ratio:

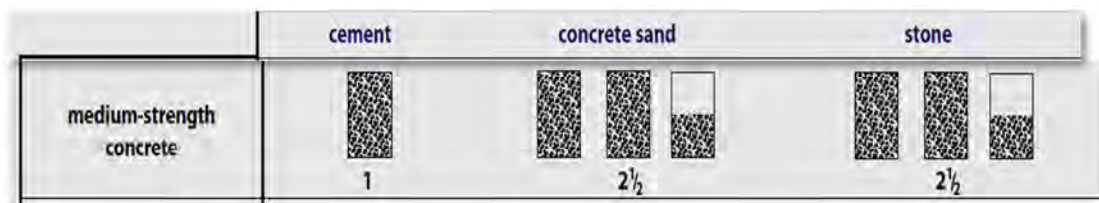

- Both representations show the same ratio. However the visual one is easier to access for large volumes where a builder is using a wheelbarrow (e.g. pouring concrete for a floor), while the number ratio is for smaller volumes (e.g. pouring concrete for a small step).

#### Example

Using the above ratios, how much stone will be required to mix with  $\psi$  a bag of cement? (Note: 1 bag of cement has a volume of 35 litres.)

Using the pictorial version: 1 bag mixes with 1 wheelbarrows of stone.

So 1 bag mixes with 1,25 wheelbarrows of stone.

So  $\psi$  a bag will need  $\psi \times 1,25 = \mathbf{0,625 \text{ wheelbarrows}}$ .

Using the ratio version: 1 part of cement mixes with 2½ parts of stone.

$\psi$  bag of cement =  $\psi \times 35$  litres = 17,5 litres of cement.

17,5 litres cement will need  $17,5 \times 2,5 = \mathbf{43,75 \text{ litres stone}}$ .

**Which is better?** 0,625 wheelbarrows seems a rather difficult amount to measure. However a normal bucket often holds about 5ℓ. So 43,75 litres is approximately 9 buckets in volume.

For smaller amounts, it seems better to use the ratio, however if there were 3 bags of cement it would be much faster to measure the sand and stone with a wheelbarrow!

## Section 2: Working with travel timetables and tide tables

(LB pages 22-27)

### Overview

The content of this section on *Working with travel timetables and tide tables*, as part of the Measurement Topic, is drawn from pages 53-54 in the CAPS document. The specific skills associated with working with time are described on pages 62-63 of the CAPS document.

As stipulated in the CAPS document, Grade 12 learners need specifically to be able to:

- read, record and perform calculations involving time values, including:  
→ timetables, transport timetables and tide timetables.

### Contexts and integrated content

- Learners need to be able to work in the context of complex projects in both familiar and unfamiliar contexts (e.g. *Timetable for a road trip or ferry ride*).
- Calculations involving timetables are also used in the topic *Maps, plans and other representations of the physical world* in order to plan journeys.

The table below shows a comparison of the different types of time-based resources that can be used to plan a journey. These are dealt with in Section 2 in the Learner's Book:

Travel Timetable	Route Map	Fare Table	Tide Timetable
<p><b>Purpose:</b></p> <p>To show the departure and arrival times of trains; buses; trams; ferries</p>	<p><b>Purpose:</b></p> <p>To show the stations/stops on several routes in a pictorial way.</p>	<p><b>Purpose:</b></p> <p>To show the price of the various travel options (e.g. single, return, weekly or monthly tickets)</p>	<p><b>Purpose:</b></p> <p>To show the times of the high and low tides at a seaside location</p>

## Measurement (conversions, time)

<p><b>Features:</b></p> <ul style="list-style-type: none"> <li>Identifies the stations/stops on a specific route</li> <li>Identifies the times of departure &amp; arrival at those stops</li> <li>Identifies limitations of the route (e.g. only Mon - Fri)</li> <li>Platforms/train numbers for a route.</li> </ul>	<p><b>Features:</b></p> <ul style="list-style-type: none"> <li>Shows several routes in different colours or types of lines (e.g. dotted vs. solid lines) so that alternatives can be analysed.</li> <li>Sometimes shows the distance between stations/stops</li> <li>Shows places of interest/transport interchanges and other useful information</li> </ul>	<p><b>Features:</b></p> <ul style="list-style-type: none"> <li>Often shows the stations/stops in the order that they occur with the relevant prices next to them</li> <li>Shows the different price options for single, return, weekly and monthly tickets</li> </ul>	<p><b>Features:</b></p> <ul style="list-style-type: none"> <li>Shows the times of the high and low tides for a port/beach.</li> <li>Specific to each port (ports in another area will have different times)</li> </ul>
<p><b>Limitations:</b></p> <ul style="list-style-type: none"> <li>Only shows certain routes</li> <li>Does not show all possible routes to get to a station/stop</li> </ul>	<p><b>Limitations:</b></p> <ul style="list-style-type: none"> <li>Does not show times</li> <li>Does not show which stations are missed out</li> <li>Often does not show when a route is operating (e.g. Mon - Fri only)</li> <li>Sometimes it gives the accurate distance between stations/stops, but not all the time</li> </ul>	<p><b>Limitations:</b></p> <ul style="list-style-type: none"> <li>Shows very limited route information (usually only the order of stations/stops)</li> </ul>	<p><b>Limitations:</b></p> <ul style="list-style-type: none"> <li>Only useful for craft on water</li> <li>Times are specific to that port (e.g. times from New York cannot be used for Cape Town).</li> </ul>

### Example

A full, integrated example which uses the resources mentioned in this section is explored in Chapter 5. Each of the resources mentioned above are explored in the additional questions below.



## Additional questions

1. The foundation of an outside room is being laid. It is pictured alongside. The volume of concrete required for the wall foundation is  $2,7 \text{ m}^3$  and the volume of concrete required for the floor is  $3 \text{ m}^3$ .

Wall  
Foundation:  
Volume =  $2,7 \text{ m}^3$

- 1.1 The floor requires a *medium-strength* concrete mixture. On the bag of cement it states that 7,7 bags of cement are required for  $1 \text{ m}^3$  of concrete. How many whole bags of cement are required for the floor?
- 1.2 The wall foundation requires *low strength* concrete which is mixed as follows:

Floor:  
Volume =  $3 \text{ m}^3$

cement	concrete sand	stone
		
1 bag	$1\frac{3}{4}$ wheelbarrows	$1\frac{3}{4}$ wheelbarrows

5,8 bags of cement are required to make  $1 \text{ m}^3$  of low strength concrete.

- 1.2.1 Calculate the total number of full wheelbarrows of stone that will be required for the wall foundation. Round your answer to the nearest full wheelbarrow.
- 1.2.2 A normal wheelbarrow can hold  $65 \text{ l}$ . Use your answer to Question 1.2.1 to calculate how many  $\text{m}^3$  of stone will need to be purchased for the wall foundation. Remember that  $1 \text{ m}^3 = 1 \text{ kl}$ . Round off to 1 decimal place.
- 1.3 Using the information from the previous questions, how many bags of cement will need to be bought in total to complete the floor and wall foundations? Show all working.
- 1.4 The floor is going to be painted with special floor paint. The floor area is  $30 \text{ m}^2$ . The spread rate of floor paint is given as  $1 \text{ l}$  covers  $11 \text{ m}^2$ . Floor paint is sold in  $5 \text{ l}$  tins for R449,00 per tin. Calculate the total cost of paint required to paint the floor with 2 coats.

## Measurement (conversions, time)

2. Use the picture of the concrete ratio from Question 1.2 and the information below to answer the following question:

1 bag(bucket) of cement = 33,2 ℓ

1 wheelbarrow = 65 ℓ

Use the picture of the concrete mixture quantities to complete the following ratio:

1 bucket of cement : ..... buckets of sand : ..... buckets of stone

3. While on holiday in Greece, a family is staying in a town called Kavos on the island of Corfu. They would like to have an outing to the small island of Paxoi which lies to the south of Corfu. The following is a portion of the hydrofoil ferry timetable for the trip between Corfu and Paxoi:

Days	Kerkira (Corfu) – Paxoi	Paxoi – Kerkira (Corfu)
Monday	8:20 - 14:45 - 18:00	7:00 - 9:45 - 16:15 - 19:15
Tuesday	6:45 - 14:30	8:00
Wednesday	9:30	8:00 - 17:30
<b>Duration</b>	<b>55 minutes</b>	
<b>Price</b>	<b>€ 17,00</b>	

- 3.1 What is the name of the port that the ferries leave from in Corfu?
- 3.2 At what times do the ferries leave on a Monday from Corfu?
- 3.3 At what times do the ferries leave on a Monday from Paxoi?
- 3.4 What time will a ferry arrive in Paxoi if it leaves at 8:20 from Corfu?
- 3.5 The family consists of 5 members (Mom, Dad and 3 children). How much will the trip to Paxoi cost them in total?
- 3.6 The family would like to spend at least 4 hours on the island of Paxoi before travelling back to Corfu on the same day. If they take the 14:45 ferry on Monday from Corfu, will they be able to spend enough time on Paxoi before having to return on the same day? Show all working.
- 3.7 The family intends to catch the 8:20 ferry on Monday. It is approximately 48 km from Kavos to the ferry terminal. They will only be able to travel at an average speed of 40 km/h. What is the latest that they will have to leave their hotel if they are to arrive with enough time to buy tickets and get on the ferry? Show all working.

## Answers

---

1. 1.1 The floor requires  $3 \text{ m}^3$  of concrete. Therefore the number of bags of cement =  $3 \times 7,7 \text{ bags} = 23,1 \text{ bags} \approx 24 \text{ bags}$ .
- 1.2 1.2.1 1,75 wheelbarrows of stone are required for every 1 bag of cement.  
Therefore no. of wheelbarrows  
=  $2,7 \text{ m}^3 \times 5,8 \text{ bags of cement} \times 1,75 = 27,405 \approx 27 \text{ wheelbarrows full}$
- 1.2.2 Total litres =  $65 \text{ l} \times 27 = 1\,755 \text{ l} = 1,755 \text{ kl} \approx 1,8 \text{ m}^3$
- 1.3 Floor = 23,1 bags  
Wall foundation =  $2,7 \text{ m}^3 \times 5,8 \text{ bags} = 15,66 \text{ bags}$ .  
Total bags of cement required =  $23,1 + 15,66 = 38,76 \approx 39 \text{ bags}$   
(note that in this case we only round off at the end of the calculation).
- 1.4 The total area to be painted =  $2 \times 30 \text{ m}^2$  (for two coats) =  $60 \text{ m}^2$ .  
Volume of paint required =  $60 \text{ m}^2 \div 11 \text{ m}^2/\text{l} = 5,45 \text{ l}$   
Even though this amount is more than 5 litres, only 1 tin would need to be bought as it is very close to 1 tin. So the total cost is R449,00.
2. 1 bag of cement =  $33,2 \text{ l}$   
1,75 wheelbarrows of sand =  $1,75 \times 65 \text{ l} = 113,75 \text{ l}$   
So the ratio of cement : sand : stone =  $33,2 \text{ l} : 113,75 \text{ l} : 113,75 \text{ l}$   
= 1 bucket : 3,4 buckets : 3,4 buckets  
(after dividing the first number in the ratio by itself, we need to divide every other number in the ratio by the same value.)
3. 3.1 Kerkira  
3.2 8:20, 14:45, 18:00  
3.3 7:00, 9:45, 16:15, 19:15  
3.4 There is a travel time of 55 minutes, so the arrival time will be:  $8:20 + 0:55 = 9:15$   
3.5 Total cost = 17 Euros  $\times$  5 people = €85  
3.6 Arrival in Paxoi =  $14:45 + 0:55 = 15:40$ . Latest departure is 19:15 on a Monday. Therefore total time available =  $19:15 - 15:40 = 3 \text{ hours } 35 \text{ minutes}$ . They will not have enough time on the island. They will have to take an earlier ferry to Paxoi.  
3.7 Time to get to Kerkira =  $48 \text{ km} \div 40 \text{ km/h} = 1,2 \text{ hours} = 1 \text{ hour } 12 \text{ minutes}$ .  
They will need to be there at least half an hour before the departure, therefore their latest departure time is:  $8:20 - 1:12 - 0:30 = 6:38$

## Section 1: Tariff systems and break-even analysis

(LB pages 34-41)

### Overview

The content of this section on *Tariff systems and break-even analysis*, as part of the Finance Application Topic, is drawn from page 50 in the CAPS document.

As stipulated in the CAPS document, Grade 12 learners need specifically to be able to compare two or more different options for a tariff system to determine the most appropriate option for individuals with particular needs by:

- performing calculations
- drawing graphs to represent the different options and interpreting the points of intersection and other regions on the graphs in relation to the context.

### Contexts and integrated content

- Learners need to be able to work in the context of larger projects that take place in the household, school or wider community. These could include several contexts (e.g. municipal tariffs, telephone tariffs, transport tariffs, bank fees, etc.).
- Drawing and interpreting graphs draws on the skills in the *patterns, relationships and representations* section of the basic skills topic.

When comparing two or more tariff systems (e.g. water tariffs, cell phone contracts, electricity systems, etc.), a standard approach can be used:

### Example

Here are three contract options for a different photocopier supplier than the one mentioned in the Learner's Book:

Key costs for photocopy rentals			
	Monthly rental fee	Additional fee (per page per month)	Free pages
Contract 1	R600,00	30 cents	None
Contract 2	R850,00	20 cents	400 pages
Contract 3	R1 150,00	10 cents	800 pages

## Finance (tariff systems and break-even, income and expenditure, cost and selling price)

### Step 1: Analyse the options individually:

To calculate the total **monthly cost** for contract 1, we need to add the **fixed monthly rental fee** to the **total amount for the no. of pages copied** made. We can therefore express this situation with the following formula:

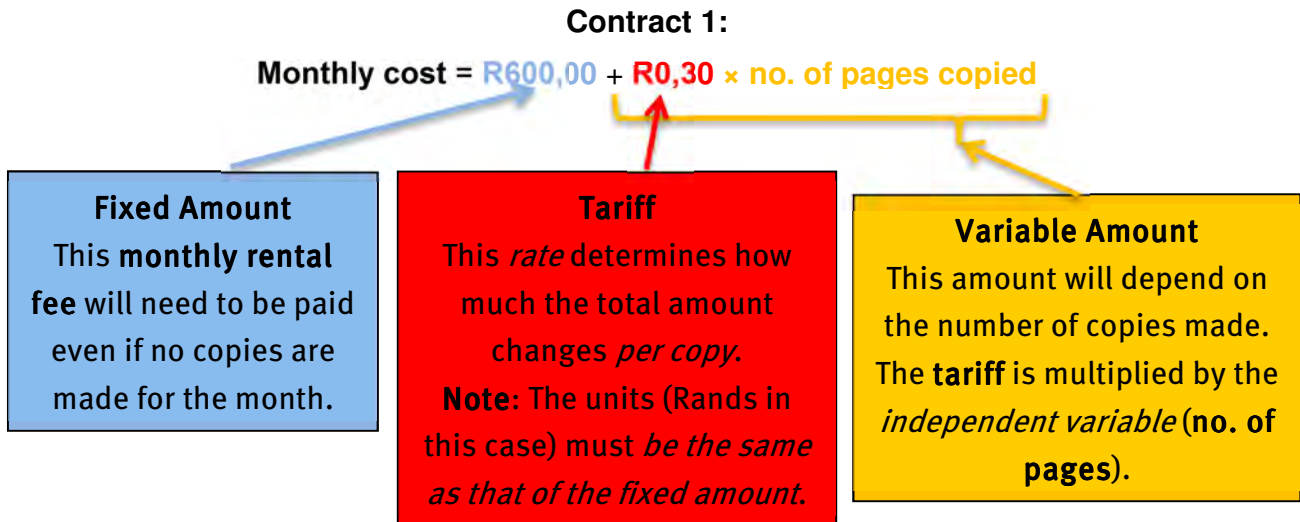

### Contract 2:

- If 400 copies (or less) are made using contract 2, then only the monthly rental fee of R850,00 will be paid.
- However if **more than 400 copies** are made then we would adjust the monthly cost formula to look like this:

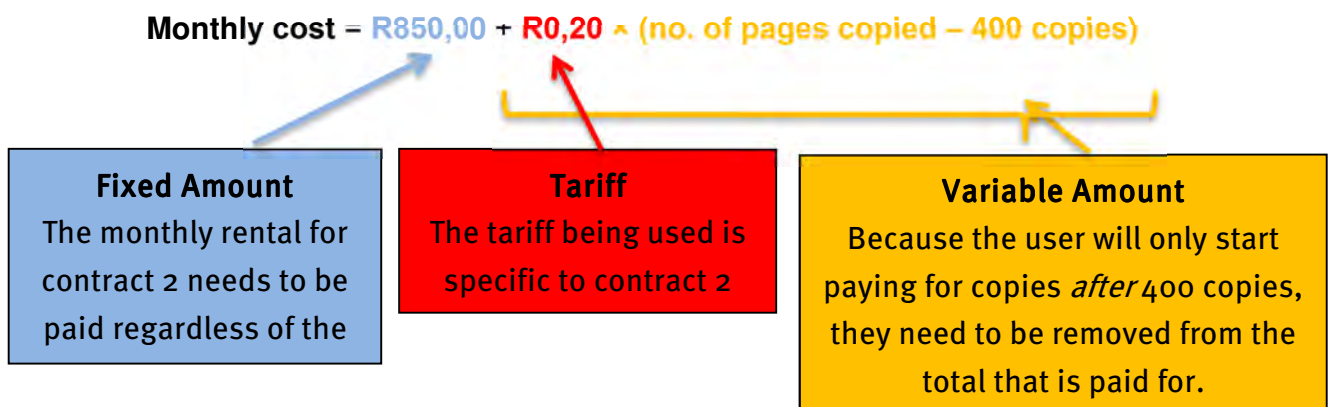

### Contract 3:

- If 800 copies (or less) are made using contract 3, then only the monthly rental fee of R1 150,00 will be paid.
- However if **more than 800 copies** are made then we would adjust the monthly cost formula to look like this:

$$\text{Monthly cost} = \text{R}1\ 150,00 + \text{R}0,10 \times (\text{no. of pages copied} - 800 \text{ copies})$$



Finance (tariff systems and break-even, income and expenditure, cost and selling price)

Step 2: Show the options in graph form

Considering the three options, the following observations can be made:

- Option 1: There is only one graph portion and it will be a straight line graph due to the constant tariff being applied.
- Option 2: There will be two sections to the graph:
  - The first section will be constant graph due to one amount being charged with no tariff applied. This will continue until 400 copies.
  - The second section will be a straight line graph starting *just after* 400 copies due to the constant tariff being applied.
- Option 3: There will be two sections to the graph:
  - The first section will be a constant graph due to one amount being charged with no tariff applied. This will continue until 800 copies.
  - The second section will be a straight line graph starting *just after* 800 copies due to the constant tariff being applied.

To aid in drawing the graphs, draw a table with the important values as the independent variable. The important values are where the changes in each option occur. Then fill in some other values in between to make drawing the graph easier:

Always try to include 0

Changing point for Option 2  
After 400 copies

Changing point for Option 3  
After 800 copies

Cost table for photocopy contracts								
Copies	0	200	400	401	600	800	801	1 000
Contract 1	R600	R660	R720	R720,30	R780	R840	R840,30	R900
Contract 2	R850	R850	R850	R850,20	R890	R930	R930,20	R970
Contract 3	R1 150	R1 150	R1 150	R1 150	R1 150	R1 150	R1 150,10	R1 170

Drawing the graph we see that we have a problem because we need to see where the options **cross each other**:

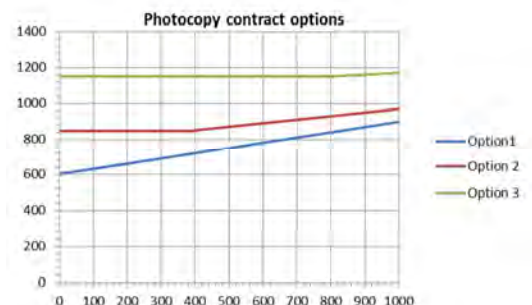

Finance (tariff systems and break-even, income and expenditure, cost and selling price)

So, by continuing the number of copies to 4 000, we get a much clearer graph of the three options:

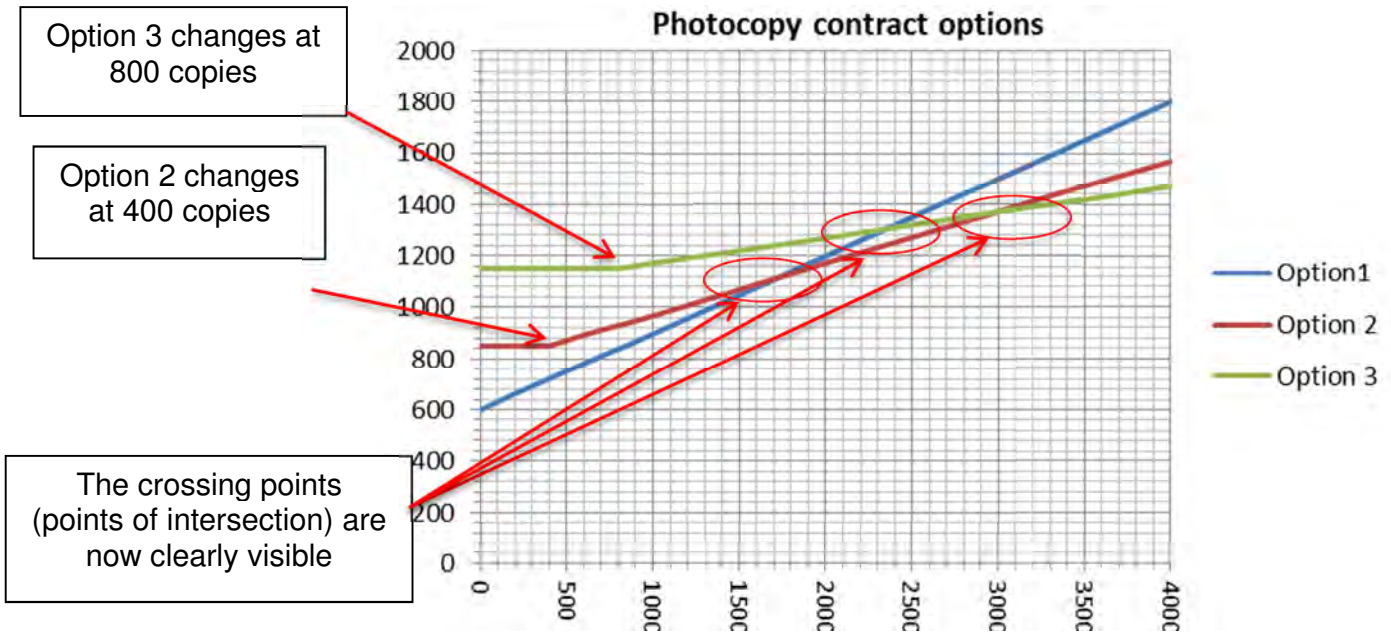

Step 3: Identify points of intersection and regions on the graph

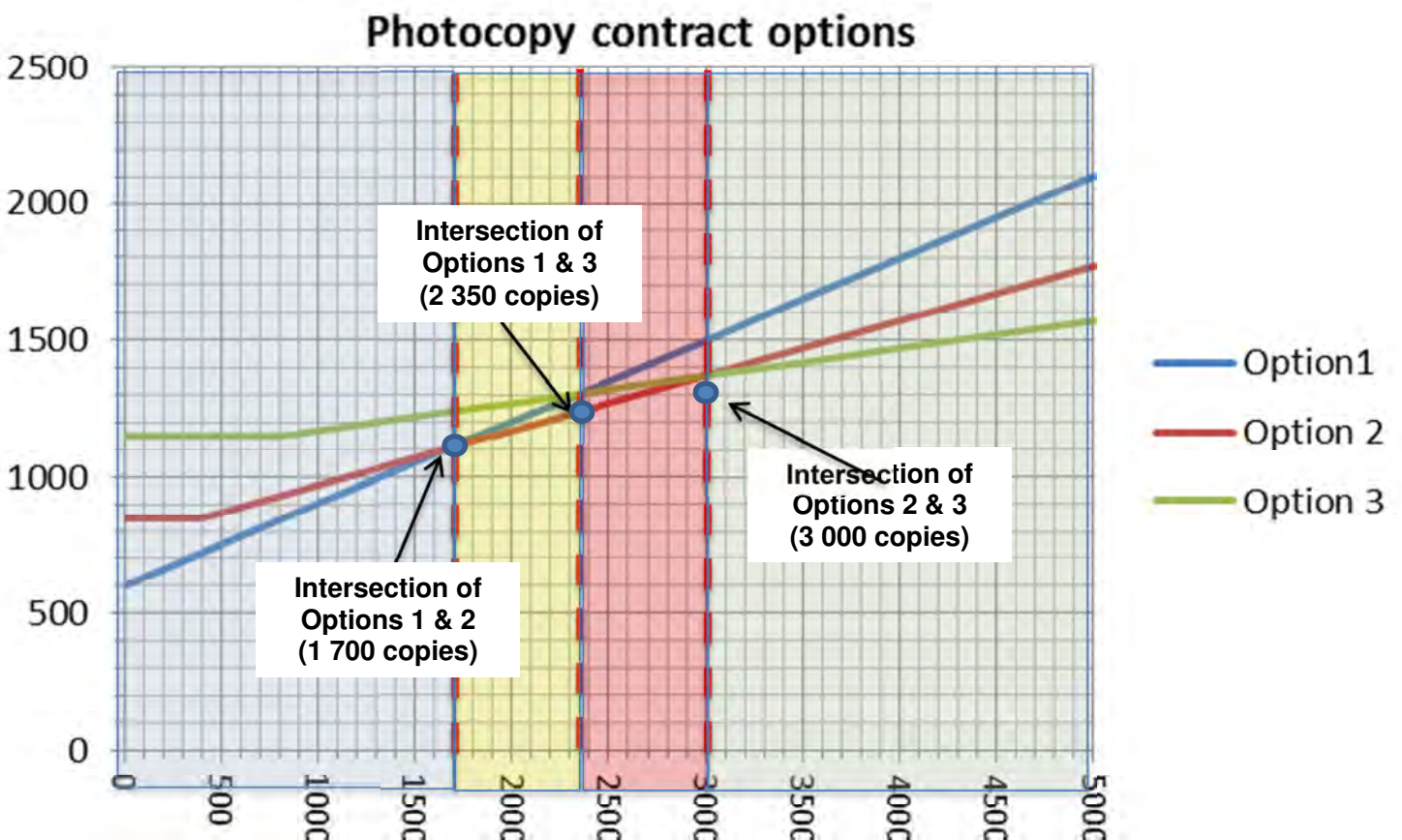

## Finance (tariff systems and break-even, income and expenditure, cost and selling price)

Region 1	Region 2	Region 3	Region 4
<ul style="list-style-type: none"> <li>Option 1 is the cheapest until 1 700 copies (R1 110).</li> <li>Option 2 is the next cheapest.</li> </ul>	<ul style="list-style-type: none"> <li>Option 2 is the cheapest between 1 700 and 2 350 copies (R1 110 to R1 240).</li> <li>Option 1 is the next cheapest.</li> </ul>	<ul style="list-style-type: none"> <li>Option 2 is still the cheapest between 2 350 and 3 000 copies (R1 240 to R1 370).</li> <li>Option 3 is the next cheapest.</li> </ul>	<ul style="list-style-type: none"> <li>Option 3 is the cheapest between after 3 000 copies (R1 370).</li> <li>Option 2 is the next cheapest.</li> </ul>

The values for the number of copies can be read off the graph and then substituted into the formulas to get the Rand-values.

### Step 4: Using the analysis

Once the analysis is complete, the regions can assist in making decisions.

### Example

A small business estimates that they will make between 1 500 and 2 500 copies per month. Which option should they choose?

**Answer:** 1 500 copies occurs in Region 1 where Option 1 is cheapest, but if the business is going to use up to 2 500 copies then Option 2 will ultimately be better as it will allow them to make more copies than their minimum in a more cost effective way.

## Section 2: Income-and-expenditure statements and budgets

---

(LB pages 42-47)

### Overview

The content of this section on *Income-and-expenditure statements and budgets*, as part of the Finance Application Topic, is drawn from pages 51-52 in the CAPS document.

As stipulated in the CAPS document, Grade 12 learners need specifically to be able to analyse the income and expenditure statements and budgets for small businesses and larger organisations (e.g. government) by:

- analysing and preparing income-and-expenditure statements and budgets for a small business (e.g. a spaza shop).
- analysing (not preparing) the income and expenditure statements and budgets for a large organisation.

### Contexts and integrated content

- Learners need to be able to work in the context of larger projects that take place in the household, school or wider community. These could include several contexts (e.g. a small business or a larger corporation).

## Finance (tariff systems and break-even, income and expenditure, cost and selling price)

This section follows on from similar discussions in Grade 11, but the context now expands to include national statistics. The two documents that are examined in the Learner's Book are the budget and the income-and-expenditure statement. Here is a summary of the two documents as used in the context of the government.

Budget	Income-and-Expenditure Statement
<p><b>Purpose:</b></p> <p>A yearly plan that sets out how the government plans to spend money to achieve goals for the country as well as the proposed income it is to receive.</p>	<p><b>Purpose:</b></p> <p>A summary of the income taken in and money spent.</p>
<p><b>Features:</b></p> <ul style="list-style-type: none"> <li>• Divided in to key areas of expenditure (e.g. education, health, etc.)</li> <li>• Expected income is identified.</li> <li>• These are not actual incomes and expenditures, but rather <i>expected</i> income and expenditures.</li> <li>• Based on the information from the Income-and-Expenditure statement of past years as well as the needs of the country.</li> <li>• Can be a <i>deficit spending</i> budget but will then need to be financed by loans which will need to be paid off in the future</li> </ul>	<p><b>Features:</b></p> <ul style="list-style-type: none"> <li>• Shows all of the <i>actual</i> incomes and expenditures in a given year.</li> <li>• Values look as if they are shown in thousands, but each value should then be multiplied by <i>a million</i> (e.g. R3 745 means R3 745 000 000)</li> <li>• Shows the data for two different periods (e.g. 2011 and 2012) so that the two years can be compared.</li> </ul>
<p><b>Limitations:</b></p> <ul style="list-style-type: none"> <li>• <i>Expected</i> amounts and not <i>actual</i> amounts. Estimates could change during the year or money not be spent as expected or income not received as expected.</li> </ul>	<p><b>Limitations:</b></p> <ul style="list-style-type: none"> <li>• Does not show the precise amount spent on each sub-section, but rather shows broad headings (e.g. provinces and municipalities, but not specifically the Free State's Mangaung municipality)</li> </ul>

## Section 3: Running a small business

---

(LB pages 48-57)

### Overview

The content of this section on *Running a small business*, as part of the Finance Application Topic, is drawn from page 51 in the CAPS document.

As stipulated in the CAPS document, Grade 12 learners need specifically to be able to analyse the income and expenditure statements and budgets for small businesses by:

- analysing and preparing income-and-expenditure statements and budgets for a small business (e.g. a spaza shop or fudge business).

### Contexts and integrated content

- Learners need to be able to work in the context of larger projects that take place in the household, school or wider community. These could include several types of small business.
- The skills involved in analysing the operations of a small business draw on several sections of the Finance Topic (including financial documents, break-even analysis, profit/loss, etc.)

## Finance (tariff systems and break-even, income and expenditure, cost and selling price)

The aim of any business is to make a profit and it is with this aim in mind that the previous two sections can be used when running a small business.

### Costs

#### Types of cost

In order to make a profit, all of the costs need to be matched by income. There are three types of costs: start-up costs, monthly costs and production costs (cost price).

Type of cost	Notes
<b>Start-up costs</b>	<ul style="list-style-type: none"> <li>• Include:               <ul style="list-style-type: none"> <li>○ Electrical appliances</li> <li>○ Equipment</li> <li>○ Furniture</li> <li>○ Shop fittings</li> <li>○ Computer equipment</li> <li>○ Other once-off expenses</li> </ul> </li> <li>• These are normally covered by a <b>loan</b> which is paid back monthly.</li> </ul>
<b>Monthly Operating costs</b>	<ul style="list-style-type: none"> <li>• Include:               <ul style="list-style-type: none"> <li>○ Rent</li> <li>○ <b>Loan repayments</b></li> <li>○ Water &amp; electricity</li> <li>○ Transport</li> <li>○ Advertising</li> <li>○ Salaries/wages</li> <li>○ Other <b>monthly</b> expenses</li> </ul> </li> </ul>
<b>Production costs</b>	<ul style="list-style-type: none"> <li>• Include:               <ul style="list-style-type: none"> <li>○ Ingredients/raw materials</li> <li>○ Packaging</li> <li>○ Other expenses incurred on a <b>day-to-day</b> basis in the direct production of the item or service.</li> </ul> </li> </ul>

#### Budget and Income and expenditure statement

A budget for a small business *estimates* the expected costs based on other similar businesses or historical data (as the business becomes more established).

An Income-and-expenditure statement reports the *actual* expenditure and income and is used to more accurately analyse and prepare a budget.

## Finance (tariff systems and break-even, income and expenditure, cost and selling price)

### Income

In terms of a retail business (which sells goods), the main source of income is from sales of the items. Determining the **Selling Price** becomes very important in order to make a profit. Selling price is the price that a product or service is sold for.

Other sources of income include:

- renting or sub-letting part of the business property
- advertising for other businesses
- other activities that cause money to come into a business.

### Profit

The **break-even point** for a business is when the income generated equals the total costs for that business for the month (or individual project).

**At the break-even point: Income = Costs**

**Note:** At the break-even, the business is just covering the costs. The business needs to make **more** than the break-even in order to make a profit.

**Profit = Total Income – Total of all costs**



## Additional questions

1. A man is buying a car. The cash price for the car is R220 000. The bank offers him two different finance options over 48 months:
- Option 1 (No Deposit): R5 772,48 per month
- Option 2 (With Deposit): R4 919,58 per month after a 15% deposit.

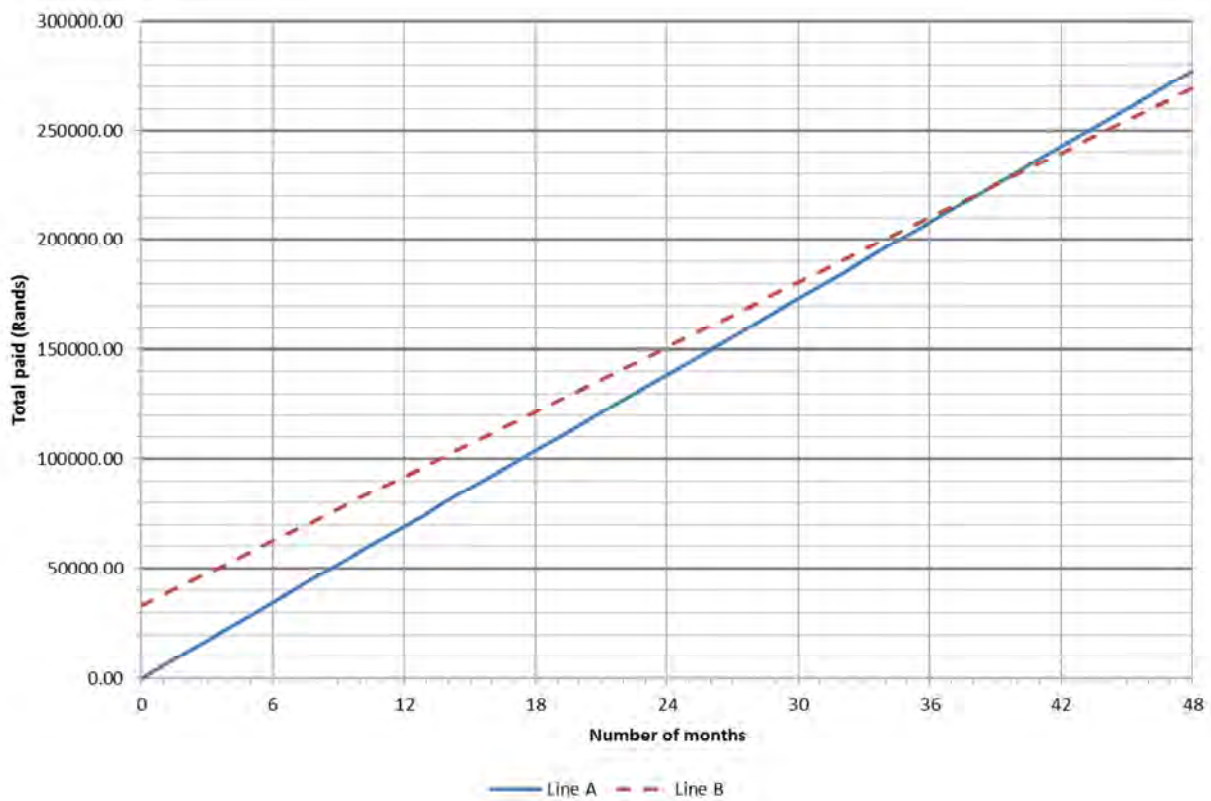

The man draws a graph of the two options:

- 1.1 Write an appropriate title for the graph.
- 1.2 Calculate the value of the deposit for Option 2.
- 1.3 How much more money per month will the man have to pay if he chooses Option 1 rather than Option 2?
- 1.4 What situation could force him to choose Option 1 (assuming that he can pay the monthly instalments)?
- 1.5 Line B represents Option 2. Give TWO reasons for this from the graph.
- 1.6 The two options break-even at a point. Give the approximate month and Rand values at that point.
- 1.7 Which option is the more expensive one after 24 months?

## Finance (tariff systems and break-even, income and expenditure, cost and selling price)

- 1.8 What is causing that option to be more expensive at that point?
- 1.9 Which option is cheaper overall? Explain how we can see this from the graph.
2. As the man begins to consider his options, he remembers that he has R50 000 in an investment that he can cash out and use as a deposit. He also decides to take the option of a balloon payment (this is a portion of the loan that is held back and only paid on the last month). The bank adjusts the finance quote as follows (for 48 months):
- Option 3: R3 746,33 per month after a R50 000 deposit and with a Balloon payment of R44 000 added to month 48.
- 2.1 How much will the man pay to the bank in month 47?
- 2.2 How much will the man pay to the bank in month 48?
- 2.3 How much will the man have paid to the bank in total over the 48 months? Show all working.
- 2.4 Using the information for Option 3 above, complete the table below:

No. of months	0	6	12	30	36	47	48
Total paid (in Rands)		R72 477,98			R184 867,88		

- 2.5 Copy the graphs from Question 1 and draw and a graph to represent Option 3 on the same axes.
- 2.6 Use your graphs from Question 2.5 above to answer the following questions:
- 2.6.1 After how many months does Option 3 become cheaper than Option 2?
- 2.6.2 After how many months does Option 3 become cheaper than both Options 1 and 2?
- 2.6.3 Referring to the graphs, which option is cheaper overall after 48 months?
- 2.6.4 If the man intends to sell the car after 2 years which payment option should he choose? Referring to the graph, give full reasoning.

## Finance (tariff systems and break-even, income and expenditure, cost and selling price)

3. In the Learner's Book, a fudge business is analysed. The most important ingredient in fudge is sugar. A local supermarket sells sugar in three sizes:

1 kg bag: R12,00

5 kg bag: R49,50

10 kg bag: R98,50

A safe assumption in business is 'bulk is cheaper', but that is not always so.

- 3.1 A graph comparing the prices of the 5 kg and 10 kg bags is shown below. Use it to answer the questions which follow:

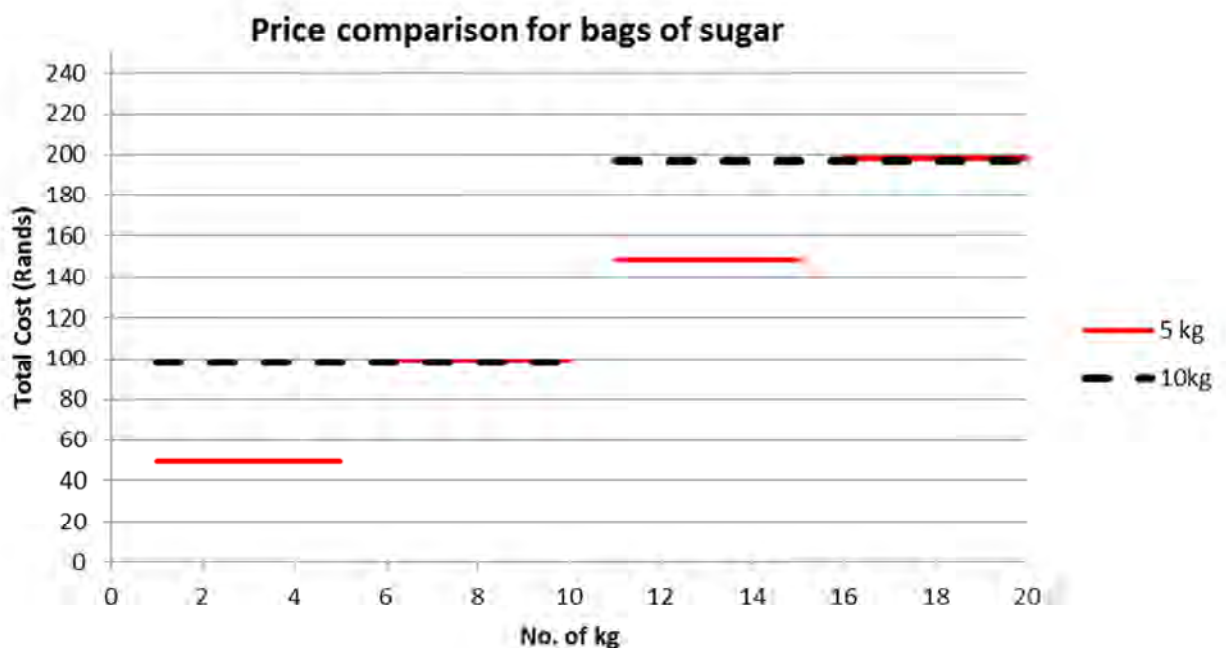

- 3.1.1 Why do the graphs go up in 'steps' (as opposed to a normal straight line graph)?
- 3.1.2 Which bag of sugar is cheaper when 12 kg's of sugar are required?
- 3.1.3 Which bag of sugar is cheaper when 18 kg's of sugar are required?
- 3.1.4 What can we conclude about the size of bag of sugar to buy?
- 3.2 Using the same axes as above, draw a graph representing the total cost for the 1 kg bag of sugar for the first 20 kg's bought. (Hint: use a straight line graph and do not bother drawing a step function).
- 3.3 Using the newly drawn graphs, answer the following questions:
- 3.3.1 Which size is cheaper if 12 kg of sugar is needed?
- 3.3.2 Which size is cheaper if 18 kg of sugar is needed?

## Finance (tariff systems and break-even, income and expenditure, cost and selling price)

3.3.3 At times it is more expensive to buy the 10 kg bags of sugar, but why might it still be a better idea to buy the larger bag of sugar anyway?

4. A woman invests in an ice-cream cone stall on the beach front. She already has full-time employment and this is an extra income for herself. In order to ensure that the stall remains open during the week and weekends, she employs a helper who works during the week and on some weekends.

Her first month's income statement looked like this:

### Start Up Costs

Kitchen Equipment	R 2 357,00
Counters & furniture	R 12 550,00
Freezer & ice cream machine	R 11 675,00
<b>Total:</b>	<b>R26 582,00</b>

### Production Costs

Milk	R 4 375,50
Cones	R 1 350,00
Toppings	R 5 517,40
<b>Total:</b>	<b>R11 242,90</b>

<b>Total Expenditure</b>	<b>R 21 164,24</b>
--------------------------	--------------------

### Operating Costs

Stall Rental	R 3 500,00
Security Guard Company	R 120,00
Electricity	R 723,45
Loan Repayment for Start-up costs	R 577,89
Wages	R 5 000,00
<b>Total:</b>	<b>R 9 921,34</b>

### Income

Ice cream sales	R15 462,50
<b>Total:</b>	<b>R15 462,50</b>

<b>Total Income</b>	<b>R15 462,50</b>
---------------------	-------------------

Refer to the income statement and answer the questions which follow:

- 4.1 Show how the total expenditure amount was calculated.
- 4.2 Explain why the Start-up Costs were not included in the costs.
- 4.3 The start-up costs do have an effect on the total expenditure. In what way do they affect total expenditure?
- 4.4 Did this business make a profit during this month? Give full reasoning.
- 4.5 Ice creams were sold at a price of R12,50 per ice cream. How many ice creams were sold during this month?
- 4.6 The production costs include the extra ingredients that have not been used yet. The production costs for one ice cream is R7,25. Using the

## Finance (tariff systems and break-even, income and expenditure, cost and selling price)

answer to Question 4.5, calculate the value of the ingredients that have not yet been used.

- 4.7 The equation for calculating the total expenditure can be given as:

$$\text{Total Expenditure} = R9\,921,34 + R7,25 \times \text{no. of ice creams sold}$$

Explain where each of the numbers in the formula comes from.

- 4.8 Use the formula from Question 4.7 and the formula for the total income to complete the following table:

No. of Ice creams sold	0	300	1 000	1 600	2 000	2 400
Total Expenditure			R17 171,34			
Total Income			R12 500,00			

- 4.9 Use the values from the table to draw graphs of the total income and total expenditure vs. the no. of ice creams sold.
- 4.10 Referring to your graphs, state the break-even point as the number of ice creams that need to be sold. Round your answer to the nearest 100 ice creams.
- 4.11 Give TWO ideas for improving the sales of the ice creams.
- 4.12 Give TWO other ways of making more income (besides selling more soft-serve ice creams).
- 4.13 Besides getting more income, give TWO other things that could be done in order to make more profit.

## Answers

---

- 1 1.1 There are many possibilities here. A good example is 'Total Paid on car vs. no. of months' (referring to the two variables and the context that they occur in).
- 1.2 15% of R220 000,00 = R33 000,00
- 1.3 R5 772,48 per month - R4 919,58 per month = R852,90
- 1.4 He might not have enough money for the deposit and so he will have to choose Option 1 (assuming that he can afford the monthly payment).
- 1.5 The line does not start at R<sub>0</sub> (due to the R33 000,00 deposit) and the line is not as steep (due to the lower monthly rate).
- 1.6 Approximately 39 months and R225 000.
- 1.7 Option 2
- 1.8 Even though the rate is lower, the deposit still causes Option 2 to be more expensive at that point.
- 1.9 Option 2. After 48 months it has a lower value.
- 2 2.1 R3 746,33
- 2.2 R47 746,33 (monthly amount + balloon payment)
- 2.3  $R3\,746,33 \times 48 \text{ months} + R50\,000 \text{ (deposit)} + R44\,000 \text{ (balloon payment)}$   
= R273 823,84
- 2.4 After 0 months: R50 000 (Before the process even begins, the deposit will need to be paid).
- After 12 months: Total =  $12 \times R3\,746,33 + R50\,000,00 = R94\,955,56$
- After 30 months: Total =  $30 \times R3\,746,33 + R50\,000,00 = R162\,389,90$
- After 47 months: Total =  $47 \times R3\,746,33 + R50\,000,00 = R226\,077,51$
- After 48 months: Total = R273 823,84 (from question 2.3)

2.5

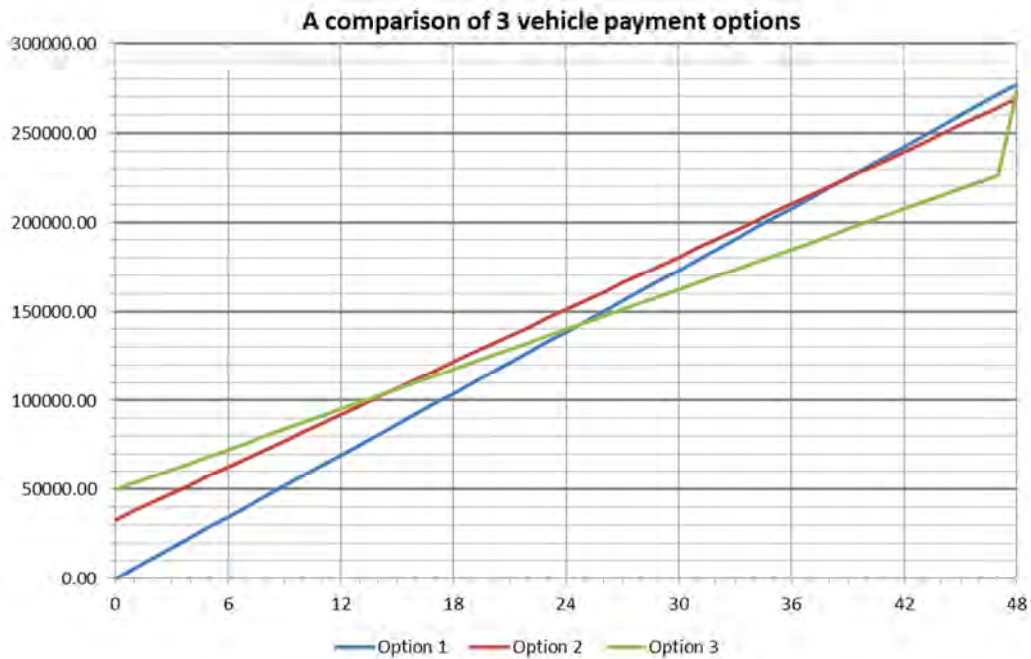

2.6 2.6.1 After 15 months

2.6.2 After 25 months

2.6.3 Option 2 (It is still the lowest overall amount after 48 months.)

2.6.4 2 years = 24 months. He would have paid the least for Option 1 by that time (although Option 3 would be a close second).

- 3 3.1. 3.1.1 You will pay the same amount for a part of the 5 kg bag (or the 10 kg bag) as you would for the entire bag. So it is the same price until you need the next bag.
- 3.1.2 5 kg bag
- 3.1.3 The 10 kg bag is very slightly cheaper, but both options are so close in price that either could be used.
- 3.1.4 Overall it would probably be better to purchase 5 kg bags as they are roughly the same price per kg as the 10 kg bags but are more versatile in that there will be less waste.

## Finance (tariff systems and break-even, income and expenditure, cost and selling price)

3.2

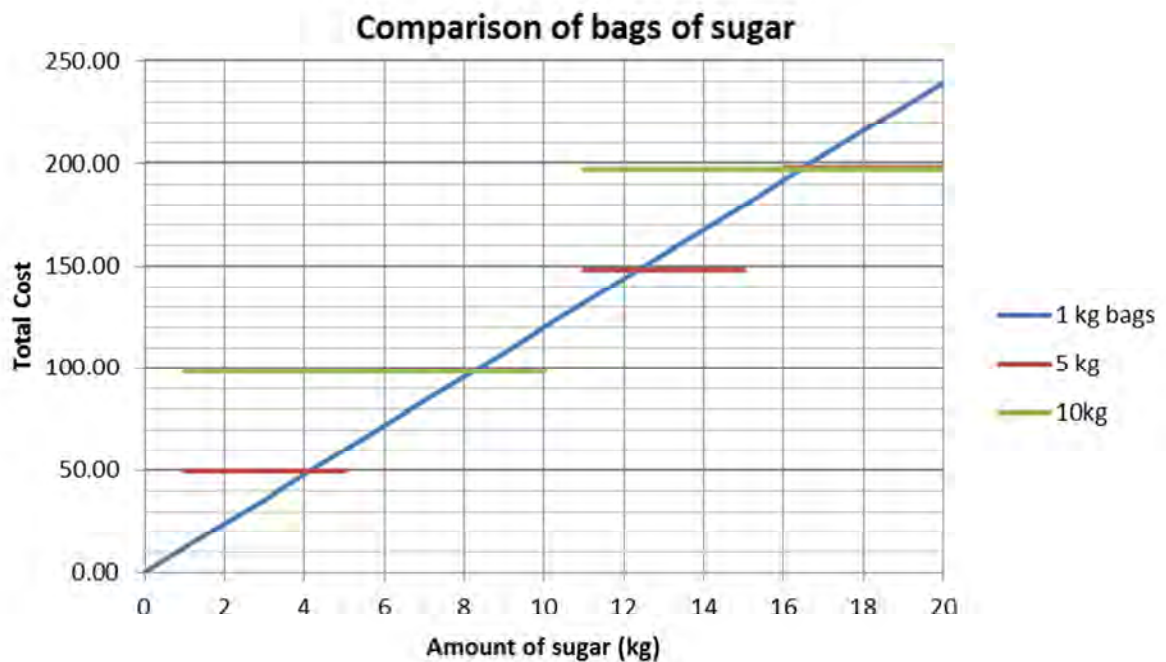

3.3 3.3.1 1 kg bag is slightly cheaper than the 5 kg bag

3.3.2 Either the 10 kg or the 5 kg (although the 10 kg bag is a little cheaper)

3.3.3 Something that has not been factored into this analysis is the cost of transport. A 10 kg bag will mean less need to travel to obtain more supplies. This will ultimately affect profitability.

4 4.1  $R9\,921,34 + R11\,242,50 = R21\,164,24$

4.2 Start-up costs are once-off costs and they are not included in on-going expenditure.

4.3 Start-up costs were covered by a loan. The loan repayment is included in the on-going expenditure until it is fully paid off.

4.4 No. The total expenditure is greater than the total income.

4.5  $R15\,462,50 \div R12,50 = 1\,237$  ice creams

4.6 Total ingredients used =  $1\,237 \times R7,25 = R8\,968,25$

Left over ingredients =  $R11\,242,90 - R8\,968,25 = R2\,274,65$

4.7 The value of  $R9\,921,34$  is the value for the operating costs and it is included in the expenditure regardless of how many ice creams are being sold.



## Finance (tariff systems and break-even, income and expenditure, cost and selling price)

4.8

No. of Ice creams sold	0	300	1 000	1 600	2 000	2 400
Total Expenditure	R9 921,34	R12 096,34	R17 171,34	R21 521,34	R24 421,34	R27 321,34
Total Income	R0,00	R3 750,00	R12 500,00	R20 000,00	R25 000,00	R30 000,00

4.9

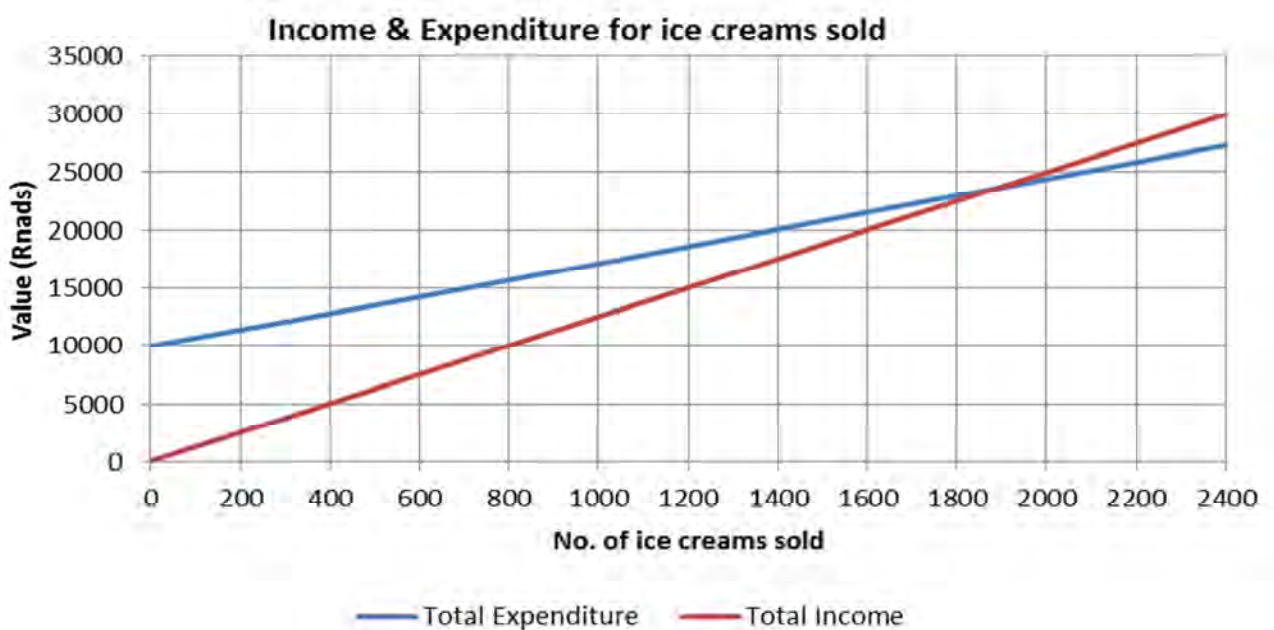

4.10 The Break-even is closest to 1 900 ice creams.

4.11 Any two sensible reasons (e.g. lower the prices; advertise better, promotions, etc.)

4.12 Any two sensible reasons (e.g. sell cool drinks/chips/sweets as well, increase prices).

4.13 Any two sensible reasons (e.g. pay the assistant less/have them work less days, try to negotiate cheaper rent, etc.)

## Section 1: Making sense of national and global statistics

---

(LB pages 62-77)

### Overview

The content of this section on *Making sense of national and global statistics*, as part of the Data Handling Application Topic, is drawn from pages 83-86 in the CAPS document.

As stipulated in the CAPS document, Grade 12 learners need specifically to be able to:

- summarise, represent and analyse data that contain multiple sets of data and multiple categories (e.g. working with vehicle statistics containing information on the number of different types of non-roadworthy vehicles in each province in South Africa).
- work with data that contains complex values (i.e. values expressed in millions or large data values) for which estimation may be necessary to determine values on graphs and in tables.
- work with data that also relates to national and global issues.

### Contexts and integrated content

- The scope of the data should include the personal lives of learners, the wider community, national and global issues.
- Some of the data representation and interpretation should include some skills from the Basic Skills topic (e.g. percentage, etc.).

In this section there are no new skills. Rather, the existing skills are applied to more than two sets of data and more than two categories of data. These are applied to more complex sets of data which deal with national and global statistics.

## Section 2: Summarising data using quartile and percentile values and interpreting box-and-whisker diagrams

(LB pages 78-89)

### Overview

The content of this section on *Summarising data using quartiles and percentiles*, as part of the Data Handling Topic, is drawn from pages 84-85 in the CAPS document.

As stipulated in the CAPS document, Grade 12 learners need specifically to be able to:

- work with quartile and percentile values, together with various measuring instruments in the following contexts:
  - growth patterns of a baby/toddler
  - health status of a child using Body Mass Index values
  - analysing the performance of a group of learners in a test/exam.

### Contexts and integrated content

- The scope of the data should include the personal lives of learners, the wider community, national and global issues.
- Some of the data representation and interpretation should include some skills from the Basic Skills topic (e.g. percentage, etc.).

### 1. Measures of central tendency

Two sets of data can be compared by looking at their measures of central tendency (mean, median and mode), but they do not always give the full picture. In Grade 12, a more complete analysis is required.

#### Example

Here are final exam results (in percentages) for two groups of matrics (grade 12's):

**Group 1:** 28 36 37 42 48 52 53 55 56 58 59 60 61 62 63 63 65 78 79 93 97

**Group 2:** 50 52 53 54 54 54 57 58 58 60 63 63 64 65 65 66 72 81

Which group performed best? One way of analysing this is to calculate the measures of central tendency for each group:

## Data handling

	Method	Group 1	Group 2
<b>Mean</b>	$\frac{\text{Total of all data}}{\text{No. of data}}$	$1\,245 \div 21 = 59,3\%$	$1\,089 \div 18 = 60,5\%$
<b>Median</b>	Middle value in an ordered data set.	The value in the middle of the data: <b>59,0%</b>	There are two values in the middle of the data, so we average them: $(58 + 60\%) \div 2$ <b>= 59,0%</b>
<b>Mode</b>	Most frequent value	<b>63%</b>	<b>54%</b>

## Analysis

<b>Mean</b>	According to the mean, Group 2 performed <i>slightly</i> better than Group 1. However, it is not enough of a difference to say that they performed significantly better.
<b>Median</b>	Both Group 1 and Group 2 have the <i>same</i> median so this measure could not decide between them.
<b>Mode</b>	According to the mode, Group 1 did better, but in this type of data, mode is not a useful measurement. There are too few of the modal data to declare it to be a good indicator.

## Limitations of measures of central tendency

<b>Mean</b>	This averages the total of the data by the number of pieces of data and is the most used measurement, but it is strongly affected by <b>outliers</b> (a piece of data that is either much larger or smaller than the main body of data)
<b>Median</b>	This is the most accurate measure of the centre of the data, but it can be very difficult to calculate with a large dataset.
<b>Mode</b>	This is often not a useful measure of the 'average'. It is only useful when the data is categorical (e.g. shoe sizes or favourite colours).

So the measures of central tendency are not enough to obtain a clear picture. At best, they are saying that the two groups performed equally well. However, if we

## Data handling

look at the data without performing any calculation, we can see that Group 1 has two very high results but also some very low results. The spread of results can give us a clearer picture:

### 2. Measures of spread

There are four measures of spread: range, quartiles, inter-quartile range and percentiles.

#### 2.1 Range

This method has been addressed in previous grades:

$$\text{Range} = \text{Maximum value} - \text{Minimum value}$$

**Group 1:** Range = 97% - 28% = 69%

**Group 2:** Range = 81% - 50% = 31%

**Analysis:** Group 1's results are very spread out. This indicates a wide spread of ability (i.e. some learners did really well, while others performed really badly). Group 2 has a much smaller range and so they are of a similar ability. However, this does not tell us how well (or badly) the group has done (e.g. if the maximum was 41% and the minimum was 10%, the range would still be 31% even though these results are clearly much worse than Group 2's results).

#### 2.2 Quartiles

Quartiles are, as their name suggests, values which occur a quarter of the way through the data. While the median divides the data in half and allows us to see which the middle value is, quartiles divide the data into quarters. In order to calculate the quartiles we *ignore the median value* of the dataset.

Here is a data set with an *odd number of data values*:

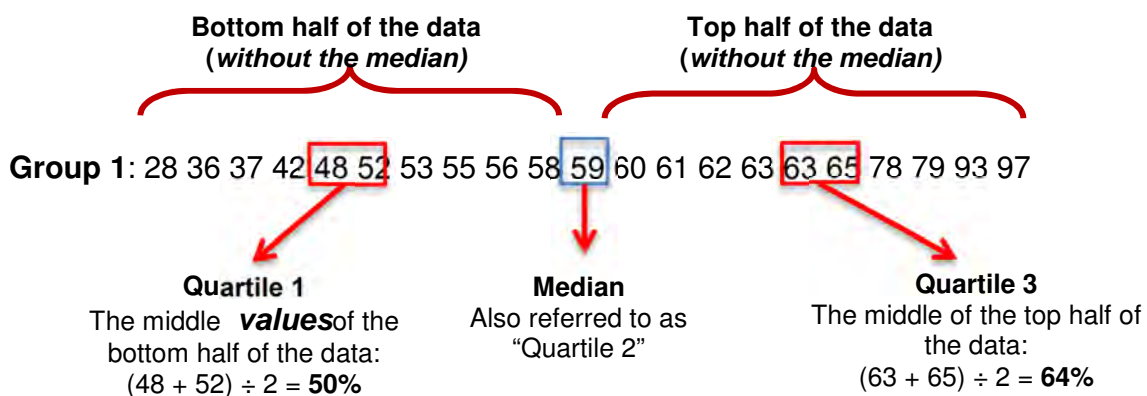

## Data handling

Here is a data set with an *even number of data*:

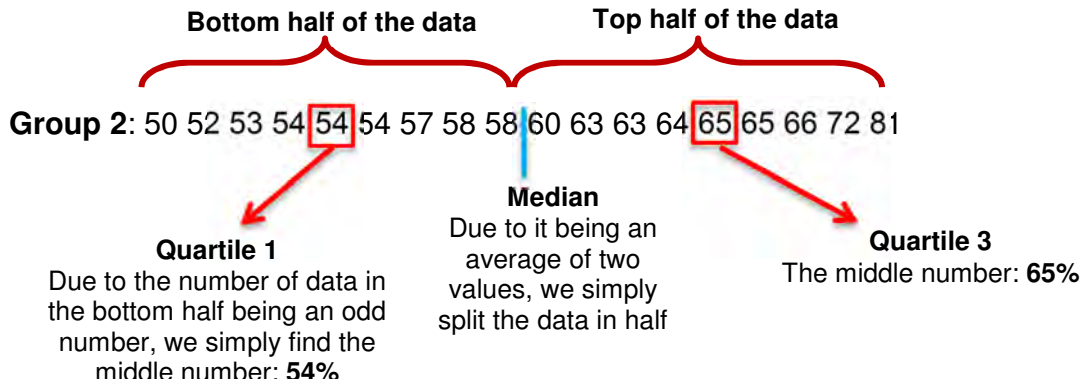

- Quartile 1 is the value of the way through the data. This means that 25% of the data is below it and 75% of the data is above it.
- Quartile 3 is the value of the way through the data. This means that 75% of the data is below it and only 25% of the data is higher than it.

**Analysis:**

	<b>Group 1</b>	<b>Group 2</b>
<b>Bottom 25% of the data</b>	<b>28% to 50%</b>	<b>50% to 54%</b>
<b>Top 25% of the data</b>	<b>64% to 97%</b>	<b>65% to 81%</b>

The bottom quarter of Group 1 scored *at most* 50%, while the bottom quarter of Group 2 scored *at least* 50%, but at most 54%.

The top quarter of Group 1 scored at least 64% which is almost the same as Group 2, but Group 1's results were as high as 97%, while Group 2's results peaked at 81%.

## Data handling

### 2.3 Inter-Quartile Range (IQR)

This is a measure of spread of *the middle 50% of the data*.

$$\text{IQR} = \text{Quartile 3} - \text{Quartile 1}$$

**Group 1:**  $\text{IQR} = 64\% - 50\% = 14\%$

**Group 2:**  $\text{IQR} = 65\% - 54\% = 11\%$

**Analysis:** We can see that although Group 2's range was very large, the IQR is much smaller indicating that the middle 50% of the group is of a similar ability. The same can be said of the ability of Group 1 as it also has a small IQR.

This indicates that Group 2 has some strong candidates and some weaker candidates, but overall the group is of a similar ability.

Group 1 is generally a group of similar ability because its range is also relatively small.

### 2.4 Box-and-whisker plots

Looking at the calculated values can be a bit confusing at times and so it is often easier to see them in picture form:

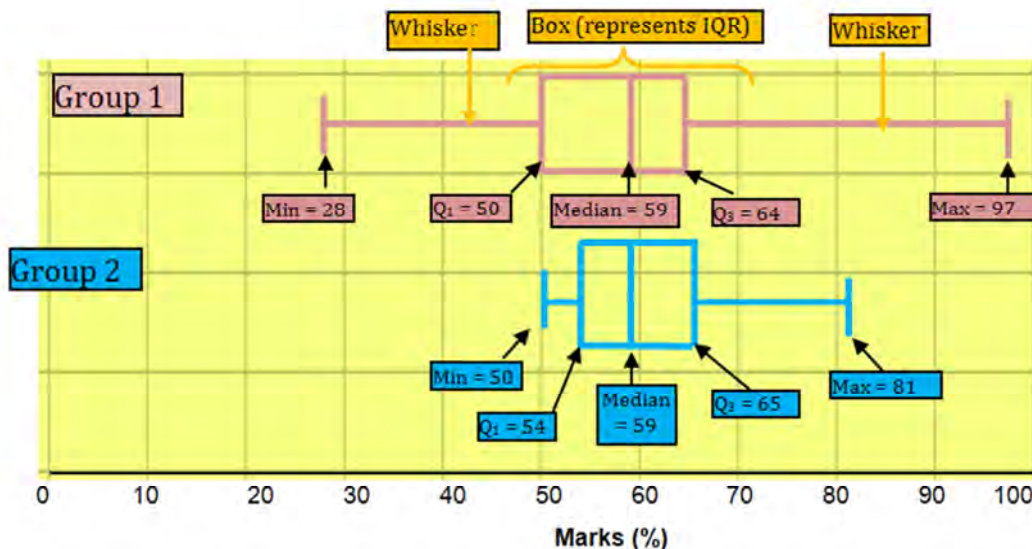

**Analysis:** The box-and-whisker plot provides the same information we have worked with but now it is much easier to see that Group 1 has a compact middle 50%, while the top 25% and the bottom 25% are very spread in terms of ability.

It is also easier to see that Group 2 is much closer in ability and also that the middle 50% of the group is slightly better than the middle 50% of Group 1, but Group 1 has more higher ability learners (the top 25%).

**Conclusion:** While neither group is necessarily better than the other one, each of the two groups is stronger in a certain area (Group 2 is more consistent, while Group 1 has more higher ability learners).

## 2.5 Percentiles

A final measure of spread is percentiles. As the name suggests, percentiles divide a group of data into a *hundred* equal parts.

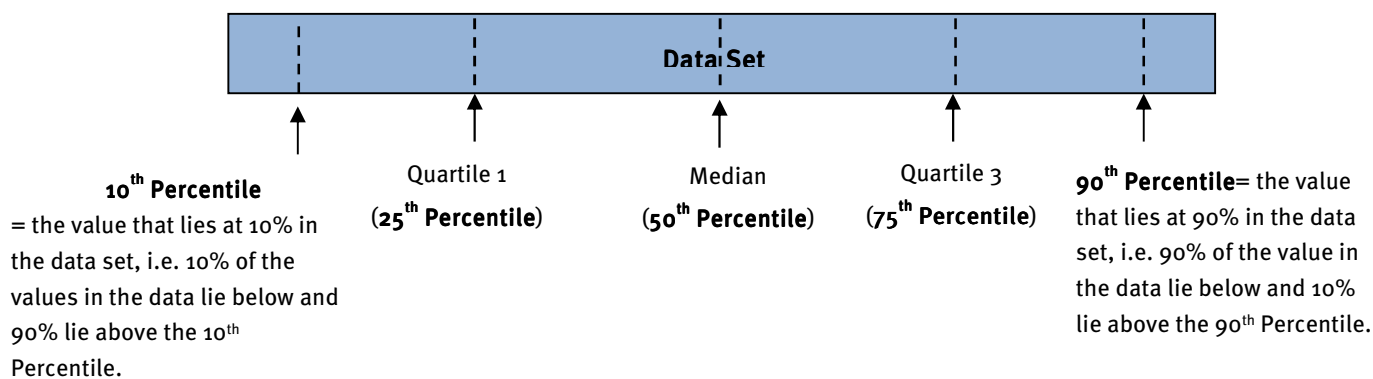

### Example

A student earned a mark of 73% for an exam and it is in the 92nd percentile of the grade.

This means that 92% of the grade obtained a mark of 73% or less for the exam and only 8% of the grade achieved a mark that was higher than (or equal to) 73%.



## Data handling

### 2.6 Growth Charts

Growth charts are a series of percentile curves that are drawn from data taken from thousands of children and then plotted.

#### Example

The following growth chart compares the age to height for girls aged 2 to 20 years. The following meanings apply:

- 3rd:** This is the curve of the *3rd percentile* of heights for the various ages. This means that any girl whose height is below this curve has a height which is shorter than the 3% of all of the data collected for that specific age.
- 50th:** This is the curve of all of the medians for each of the ages.
- 90th:** This is the curve of the *90th percentile* of heights for the various ages. This means that any height above it is taller than 90% of the data collected for that age group.

Consider the portion of the growth chart below (the original can be found in the Learner's Book on page 82).

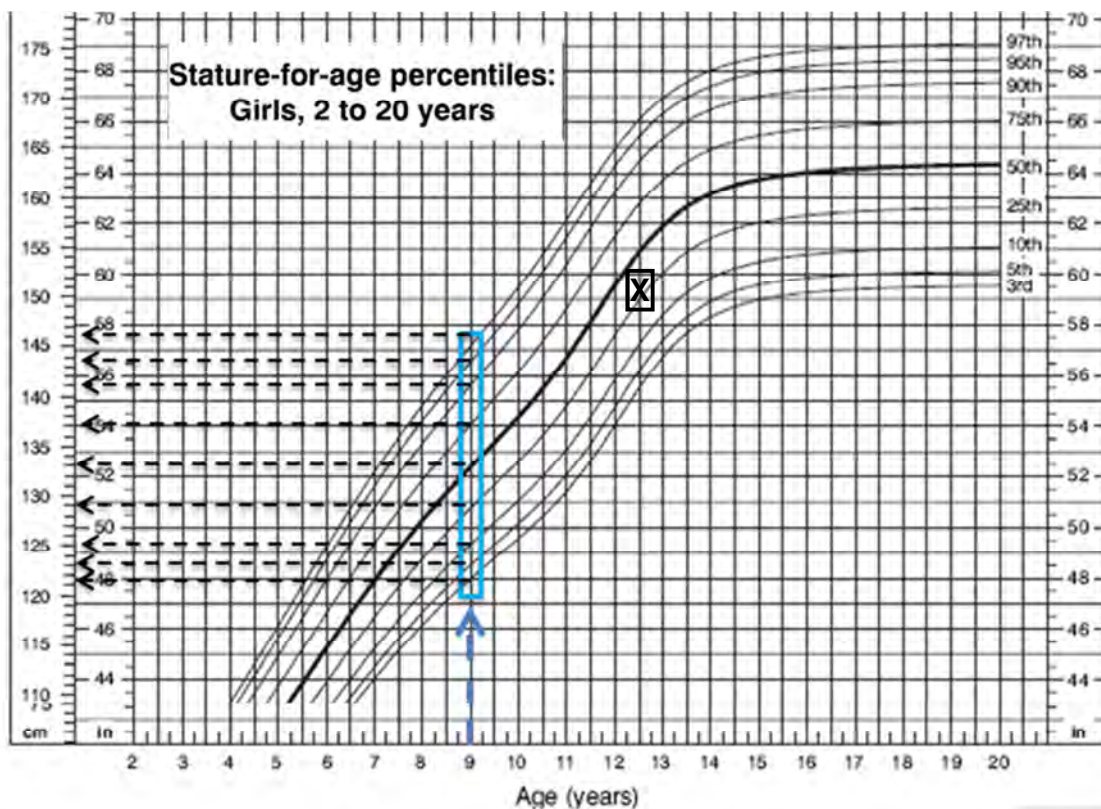

The vertical lines allow us to read off the various values for a certain age of girl. In

## Data handling

the above example, a girl of 9-years-old is chosen. If we follow the vertical line we can see where it meets the various percentile curves and read off the values on the scale at the side of the graph:

Percentile	3 <sup>rd</sup>	5 <sup>th</sup>	10 <sup>th</sup>	25 <sup>th</sup>	50 <sup>th</sup>	75 <sup>th</sup>	90 <sup>th</sup>	95 <sup>th</sup>	97 <sup>th</sup>
Height (in cm)	121	123	125	129	133	137	141	144	146

- Therefore if a 9-year old had a height of 124 cm, her height would be between the 5<sup>th</sup> and 10<sup>th</sup> percentiles for her age. In other words, she would be considered short for her age.
- Consider the girl who is 12 years and 6 months old and who is 151cm tall. On the growth curve her age and height meet at the point marked X. Her height lies between the 25<sup>th</sup> and 50<sup>th</sup> percentile growth curve. A 'normal' (or 'average') girl would have a height that fell between the 25<sup>th</sup> and 75<sup>th</sup> percentile (in the middle 50% of the data). So this girl is 'normal' although she is at the shorter end of the range for her age.

## Section 3: Develop opposing arguments using the same summarised and/or represented data

(LB pages 90-93)

### Overview

The content of this section on *Develop opposing arguments using the same summarised and/or represented data*, as part of the Data Handling Topic, is drawn from page 87 in the CAPS document.

As stipulated in the CAPS document, Grade 12 learners need specifically to be able to:

- compare different representations of multiple sets of data and explain differences.
- develop opposing arguments using the same summarised and/or represented data.

### Contexts and integrated content

- The scope of the data should include the personal lives of learners, the wider community, national and global issues.
- Some of the data representation and interpretation should include some skills from the Basic Skills topic (e.g. percentage, etc.).

It is often possible to interpret statistical information in different ways. People present or justify different viewpoints based on their interpretations. In this section we will explore the ways in which the same information can be interpreted differently by different groups.

Consider the graph to the right. It is found in the Learner's Book on page 78. This graph of learners' results could be interpreted in various ways:

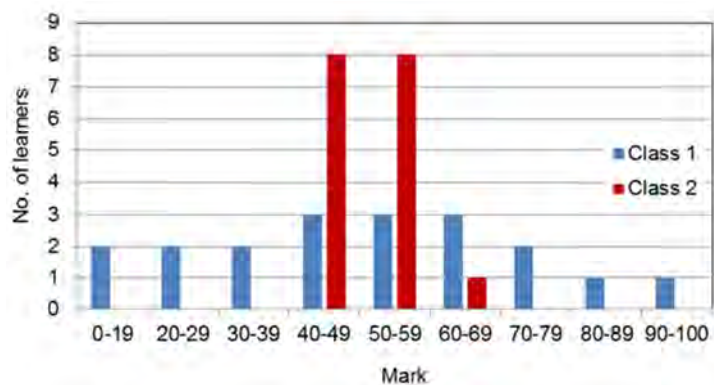

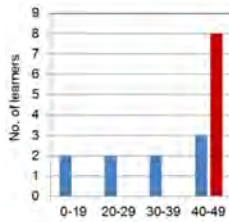
**Correct Interpretations:**

Looking at the first half of the graph only:

'Class 1 did much worse than Class 2 because Class 2 does not have any marks less than the 40% – 49% range.'

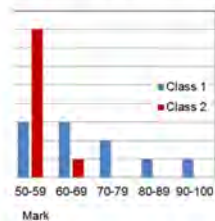

Looking at the second half of the graph only:

'Class 2 did much better than Class 1 because Class 1 does not have any mark higher than the 60% – 69% range.'

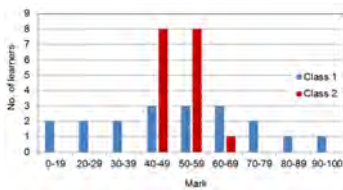

Considering the whole graph:

'Class 2 is more consistent than Class 1 because their values are grouped closer together.'

All of the above are correct interpretations which are drawn from a selective view of the information.

**Incorrect Interpretations:**

- 'Class 2 did better than Class 1 because their graphs are taller'. The heights of the bars only indicate how many pieces of data occurred in that range. They do not indicate 'better' or 'worse'.
- 'Class 2 has higher marks in the 50% – 59% range, but lower marks in the 60% – 69% range because of the heights of the bars in those ranges'. The ranges do not specify how many low values and how many high values each class has in that range. They only indicate that a value occurred in that range. They could *all* be low.

## Additional questions

---

1. Barry takes both Geography and Life Science as subjects. He is trying to determine in which subject he performs better.

- 1.1 Barry has the following percentages for his Geography tests during this year:

**35 36 38 43 56 58 58 60 60 60 61 95**

The 5-number summary (min - Q1 - median - Q3 - max) of the above data is as follows:

**35 ; 40,5 ; 58 ; 60 ; 95**

- 1.1.1 By using calculations, explain why the value for the first quartile (Q1) is a decimal when all of the values in the data set are whole numbers.
- 1.1.2 Explain what a third quartile (Q3) value of 60% means.
- 1.2 These are Barry's Life Science test results from this year:

**35 36 50 51 53 58 60 60 64 65 73**

- 1.2.1 Calculate the mean of both sets of test results and explain why the mean is not a useful way to determine his stronger subject in this case.
- 1.2.2 Determine the 5-number summary (min - Q1 - median - Q3 - max) of the Life Science data.
- 1.2.3 Use your answer to Question 1.2.2 to answer Barry's question about which of the two subjects is his stronger subject.
2. These were the final results of a group of matric students (as percentages):

**74 75 60 52 75 68 67 76 42 70 58  
78 75 65 55 75 76 55 49 81 69 60**

- 2.1 Calculate the mean of these results.
- 2.2 Work out the median for these results.
- 2.3 Work out the 5-number summary for the results (min - Q1 - median - Q3 - max).

- 2.4 Use your answer to Question 2.3 to compare these results with the two sets of results from the example in Section 2 under *Measures of central tendency*. How did this group of matric learners perform when compared with the other two groups? Give a detailed analysis.

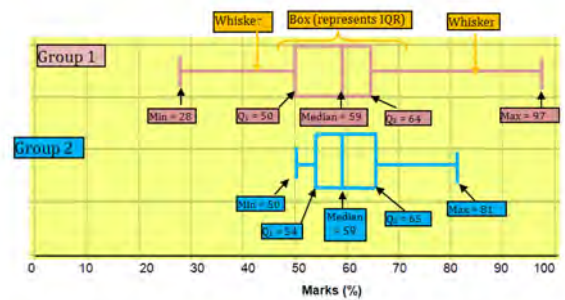

3. The table below contains the prices of houses that were sold in two areas during the first six months of a year. The house prices have been arranged in ascending order.

Dawnview		Cicily	
R150 000	R525 000	R300 000	R510 000
R160 000	R530 000	R320 000	R512 000
R175 000	R540 000	R320 000	R515 000
R190 000	R550 000	R340 000	R518 000
R212 000	R570 000	R360 000	R520 000
R225 000	R570 000	R365 000	R523 000
R400 000	R580 000	R400 000	R690 000
R520 000		R440 000	

- 3.1 For Dawn view, the mean house price is R393 133,33, the median house price is R520 000 and modal house price is R570 000. Explain which measure of central tendency provides the most accurate indication of the average house price in Dawnview. In your answer you must also explain why the other measures of central tendency are not appropriate.

## Data handling

- 3.2 The graphs below show the minimum, maximum, median, 1st quartile and 3rd quartile house prices for Dawnview and Cicily. Compare the 5-number summaries for the two areas and give an overview of the house prices in the two areas.

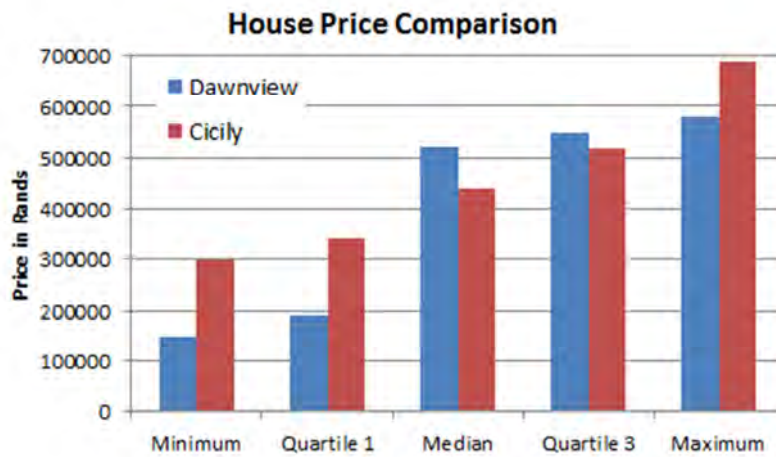

4. Patrick came home one day and proudly announced that he had achieved the 75<sup>th</sup> percentile in his class for a test. His parents were happy as they had agreed that his goal should be a Level 6 (70 – 79%) mark. However, Patrick’s mark was 62%.
- 4.1 What is another name for the ‘75<sup>th</sup> percentile’?
  - 4.2 How is it possible that Patrick got 62%, but his mark is in the 75<sup>th</sup> percentile?
  - 4.3 How did his parents interpret his statement?

## Data handling

5. The results of the 2011 Census of the South African population have been released. The graph below shows the highest level of education achieved by the population who were 20 years and older. Use it to answer the questions which follow:

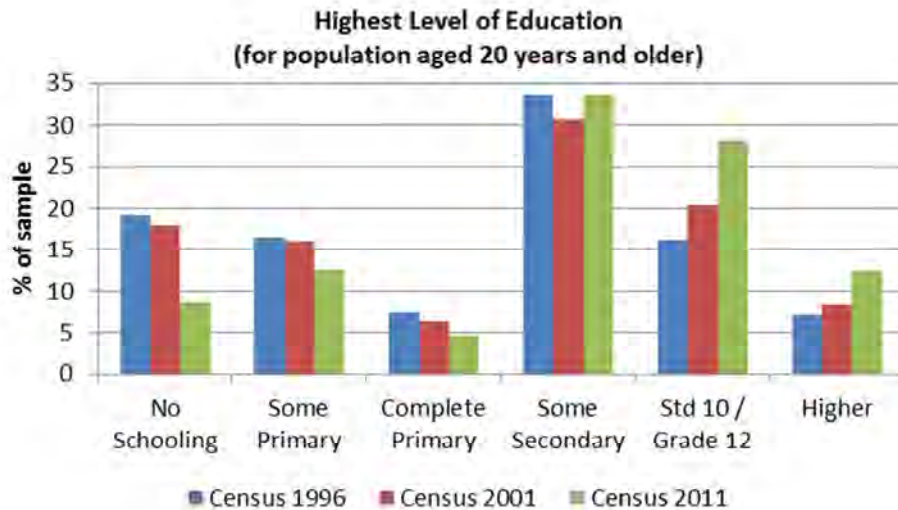

- 5.1 Why does this question about the highest level of education only apply to persons who are 20 years or older?
- 5.2 The following statements are flawed. State where the error lies with reasons:
- 5.2.1 The percentage of people who have only completed primary has decreased from 1996 to 2011; therefore people have become less educated over this time period.
- 5.2.2 The number of people in the category 'some secondary' has improved compared to the levels in the 1996 survey.
- 5.2.3 Women have become more educated over this time period.



## Answers

---

- 1 1.1 1.1.1 The first quartile occurs between the values 38 and 43, so the value for Q1 is  $(38 + 43) \div 2 = 40,5$ .
- 1.1.2 This means that he achieved 60% or more in a quarter of his tests (25%) or that he achieved 60% or less in three quarters (75%) of his tests.
- 1.2 1.2.1 Geography: Mean = total of all data  $\div$  no of data =  $660 \div 12 = 55\%$   
 Life Science: Mean =  $605 \div 11 = 55\%$   
 Therefore the mean is the same for both sets of data and cannot be used to decide in which subject he performed better.
- 1.2.2 Minimum = 35 %  
 Quartile 1 = 50 % (halfway through the bottom half of the data; 58% is excluded as it is the median)  
 Median = 58% (the value in the middle of the data)  
 Quartile 3 = 64% (Halfway through the top half of the data)  
 Maximum = 73%
- 1.2.3 Overall, it seems as if he did better in *Life Science*. This is due to the minimum and median being the same for both Geography and Life Science. However, in Life Science the quartiles were both higher which indicated that his middlemost results are better in Life Science. The higher maximum in geography was a once-off result and does not indicate an overall trend. Therefore it can be ignored in this analysis.
- 2.1 66,14% (same method as question 1.2.1)
- 2.2 The results first need to be sorted into ascending order:  
 42 49 52 55 55 58 60 60 65 67 68  
 69 70 74 75 75 75 75 76 76 78 81  
 The middlemost value occurs between 68 and 69, therefore the median =  $(68 + 69) \div 2 = 68,5\%$
- 2.3 The data is already arranged in ascending order for the previous question, so the values can be read from their relative positions:  
 Minimum = 42 %  
 Quartile 1 = 58 % (halfway through the bottom half of the data; 68% is included as the median occurs between it and the next number in the dataset)

## Data handling

Median = 68,5%

Quartile 3 = 75% (Halfway through the top half of the data)

Maximum = 81%

- 2.4 CAPS does not require the student to draw a box-and-whisker plot but it can be a very useful analytical tool. Here we see the box-and-whisker plot of the third group's data next to the two existing box-and-whisker plots:

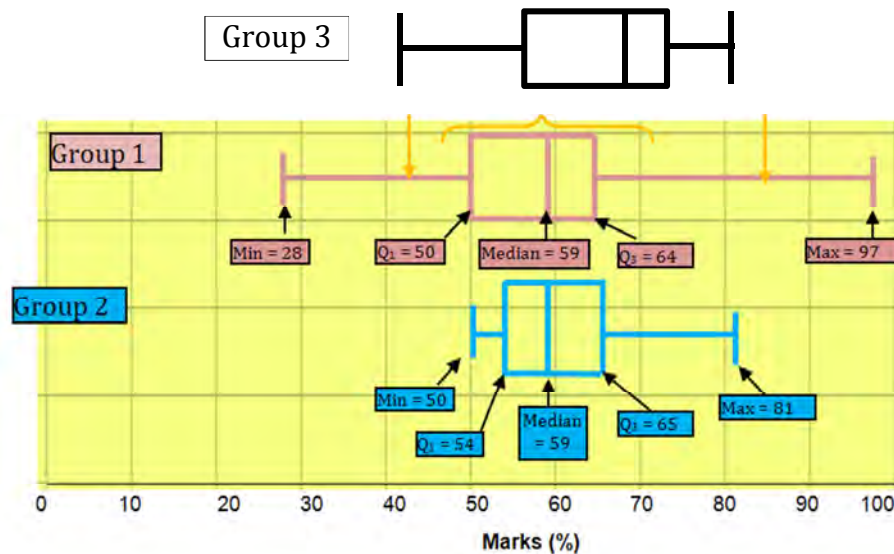

It can be immediately seen from the analysis that Group 3's 'box' is higher than both of the other groups. This can also be seen in the Quartile 1 and 3 values being higher than the related values in Groups 1 & 2. The Median for Group 3 is also higher, indicating that the average student in Group 3 did better than the average student in both of the other groups. The other groups may have an advantage in terms of the minimum and maximum values but where it is most important (i.e. the middle values of the data set), Group 3 performed better overall.

- 3 3.1 The median is the most accurate measure of the central tendency for Dawnview as the data set is rather small and can be distorted by outliers (in this case, the lower values in the data set).

The mean is especially distorted by outliers (it is far lower than expected).

The mode is simply the value that occurs most often and is not a good measure of central tendency for continuous quantitative data.

- 3.2 Cicily seems to have a steady increase in prices across the 5-number summary, while Dawnview has two distinct groupings of houses (a low income group and a high income group). The 'average' house in Dawnview

## Data handling

is of higher value than in Cicily indicating that it is a more affluent neighbourhood, but not by much. The two neighbourhoods seem to be similar, except that Dawnview has a much larger range of house prices.

- 4 4.1 Quartile 3
- 4.2 Patrick's mark is three quarters of the way through the dataset and therefore he is simply stating the position of his test result relative to the rest of the class. If the class did not do well in the test then he too would probably not have done well.
- 4.3 His parents interpreted '75<sup>th</sup> percentile' as '75%'. This was not correct (although he was not going to tell them)!
- 5 5.1 Anyone younger than 20 years old is most likely still in school.
- 5.2 5.2.1 This is not true because the decreases in the 'complete primary' have become increases in later categories which indicates that people are more educated now than they were before.
- 5.2.2 This graph does not deal in *numbers* of people, but rather *percentages* so the correct statement would read "The percentage of people in the ..."
- 5.2.3 This graph does not differentiate between men and women in the sample. Both genders are mixed in the results. Such a conclusion would need a different analysis.

## Section 1: Interest and banking: loans and investments

(LB pages 102-119)

### Overview

The content of this section on *Loans and Investments*, as part of the Finance Application Topic, is drawn from pages 55-57 in the CAPS document.

As stipulated in the CAPS document, Grade 12 learners need specifically to be able to:

- investigate the effect of changes in the interest rate on the cost of a loan and on the final/projected value of an investment.
- investigate the effect of changes in the monthly repayment amount on the real cost of a loan.
- investigate the effect of changes in the monthly investment amount on the value of the final investment.

### Contexts and integrated content

- Learners need to be able to work in the various contexts relating to loans in investments (e.g. payments on a housing loan, a car loan, an annuity investment, etc.)

### 1. Loans

A loan is where a lump sum is borrowed from a bank or other loan agent in order to make a large purchase (e.g. a house, car, etc.). This loan amount is repaid in smaller monthly amounts that have interest added to them. This interest is calculated at a set rate on the remaining money owed.

**PELHAM: R895 000**



**Deposit:** 15%  
**Loan Length:** 20 years  
**Interest Rate:** 11,0% p.a.

In order to explore the important terms, we will look at the purchase of the house above according to the listed conditions.

## Finance (interest, banking, inflation)

### Important terms:

Term	Explanation																																															
Sale Price	The stated price of the item to be purchased (e.g. sale price of a house, cash price of a car, etc.) <b>Answer: R895 000,00</b>																																															
Deposit	An amount that must be paid upfront before the loan is guaranteed. It is often stipulated as a percentage of the loan amount. <b>Answer: 15% of R895 000 = <math>15 \div 100 \times R895\ 000 = R132\ 450,00</math></b>																																															
Loan Amount	The actual amount owed to the bank or loan agent. Loan Amount = Sale Price – Deposit <b>Answer: Loan Amount = <math>R895\ 000,00 - R132\ 450,00 = R760\ 750,00</math></b>																																															
Interest Rate	The percentage of the loan amount that will be charged as a ‘fee’ for borrowing the money. It is calculated on the balance owed. <b>Answer: 11,0% p.a.</b> <b>However, interest is worked out on a monthly basis, so the monthly rate = <math>11,0\% \div 12 = 0,916666\%</math> per month.</b>																																															
Interest	The amount paid for loaning the money. Calculated on the amount owed at the end of each month. <b>Answer: First month = <math>R760\ 750,00 \times 0,916666\% = R6\ 973,54</math></b> <b>(This calculation is performed every month on the balance in the account. As it changes so will the interest charged.)</b>																																															
Loan length	The amount of time a person has to pay back the loan (e.g. 5 or 6 years for a car or 15 or 20 years for a house). Also known as the ‘life of the loan’. <b>Answer: 20 years</b>																																															
Monthly repayments	The amount of money that must be paid back to the bank or loan agent every month. A table of values is used to calculate the monthly repayment according to the following method: $\text{Monthly repayments} = \text{loan amount} \div 1\ 000 \times \text{factor}$ The factor is obtained from a table of values such as this one: <table border="1" style="margin: 10px auto;"> <thead> <tr> <th colspan="8">Factor values</th> </tr> <tr> <th rowspan="2">Loan Period</th> <th colspan="7">INTEREST RATE</th> </tr> <tr> <th>10%</th> <th>10,25%</th> <th>10,5%</th> <th>10,75%</th> <th>11%</th> <th>11,5%</th> <th>12%</th> </tr> </thead> <tbody> <tr> <td>15 years</td> <td>10,75</td> <td>10,9</td> <td>11,05</td> <td>11,21</td> <td>11,37</td> <td>11,68</td> <td>12</td> </tr> <tr> <td>20 years</td> <td>9,65</td> <td>9,82</td> <td>9,98</td> <td>10,15</td> <td>10,32</td> <td>10,66</td> <td>11,01</td> </tr> <tr> <td>25 years</td> <td>9,09</td> <td>9,26</td> <td>9,44</td> <td>9,62</td> <td>9,8</td> <td>10,17</td> <td>10,53</td> </tr> </tbody> </table> <b>Answer: Monthly repayment = <math>R760\ 750,00 \div 1\ 000 \times 10,32 = R7\ 850,94</math></b> <b>(Note: this will always be larger than the first month’s interest as it must cover all of the interest and a little more which will reduce the balance owed.)</b>	Factor values								Loan Period	INTEREST RATE							10%	10,25%	10,5%	10,75%	11%	11,5%	12%	15 years	10,75	10,9	11,05	11,21	11,37	11,68	12	20 years	9,65	9,82	9,98	10,15	10,32	10,66	11,01	25 years	9,09	9,26	9,44	9,62	9,8	10,17	10,53
Factor values																																																
Loan Period	INTEREST RATE																																															
	10%	10,25%	10,5%	10,75%	11%	11,5%	12%																																									
15 years	10,75	10,9	11,05	11,21	11,37	11,68	12																																									
20 years	9,65	9,82	9,98	10,15	10,32	10,66	11,01																																									
25 years	9,09	9,26	9,44	9,62	9,8	10,17	10,53																																									

## Finance (interest, banking, inflation)

Real Cost of the loan	The total amount that will be paid for the loan over the whole life of the loan. Real cost = Monthly repayment amount × number of repayments made <b>Answer: Real Cost = R7 850,94 × (20 years × 12 months per year)</b> <b>= R1 884 225,60</b>
Interest paid on a loan	The total of all interest that is charged on the loan. Interest Paid = Real cost – Original Loan amount <b>Answer: Interest Paid = R1 884 225,60 – R760 750,00</b> <b>= R1 123 475,60</b>

### Modelling a loan scenario in a table

In order to see what is happening to a loan, we could draw up a table such as the one below:

Loan model table					
Loan Conditions	House price	R895 000	Interest rate (per year)	11,0%	
	Deposit	15% (R132 450)	Interest rate (per month)	0,916666%	
	Loan amount	R750 760	Loan period	20 years or 240 months	
Changes to the amount owing on the loan over the life of the loan					
Month	Opening Balance	Interest	Balance with interest	Repayment	Closing balance
1	R750 760,00	R6 973,54	R767 723,54	R7 850,94	R759 872,60
2	R759 872,60	R6 965,50	R766 838,10	R7 850,94	R758 987,16
---	---	---	---	---	---
100	R620 248,60	R5 685,61	R625 934,21	R7 850,94	R618 083,27
---	---	---	---	---	---
239	R16 706,58	R153,14	R16 859,72	R7 850,94	R9008,78
240	R9008,78	R82,58	R9 091,36	R9 091,36	R0,00

Notes:

- The closing balance of the previous month becomes the opening balance of the next month.
- Interest is calculated on the opening balance of each month.
- Interest is first calculated. Then it is added to the opening balance and *only then* does the repayment amount get subtracted to get the closing balance.
- The final month's repayment is often *slightly larger* than the normal monthly repayment. This will *increase the Real Cost* of the loan slightly.
- The graph of the closing balances vs. no. of months is shown alongside:  
(Notice that it decreases slowly at first, but faster as it draws closer to the end of the loan.)



## Finance (interest, banking, inflation)

### Factors that reduce the total amount owed

The total amount owed over the life of the loan must include both the deposit and the small amount extra that is paid on the final payment:

$$\begin{aligned} \text{Total cost of Loan} &= \text{Real Cost} + \text{Deposit} + \text{extra payment} \\ &= R1\,884\,225,60 + R132\,450,00 + (R9\,191,36 - R7\,850,94) \\ &= R2\,018\,016,02 \end{aligned}$$

This total amount owed is affected by certain factors. It can be reduced in several ways by manipulating these factors. The table below shows the effect of these factors on the original example:

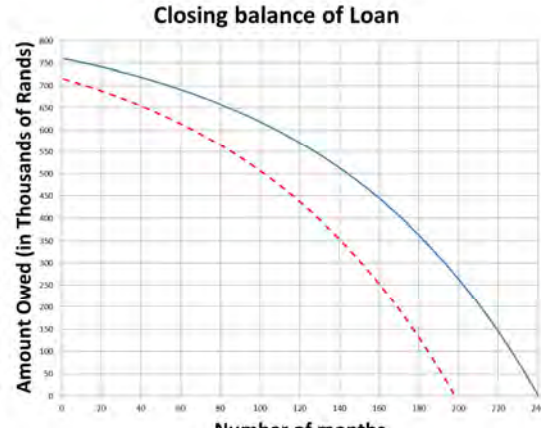
Factor	Effect
Deposit	<p>The larger the deposit, the lower the loan amount. Therefore there is less borrowed and thus less interest is paid on the loan.</p> <p><b>Scenario:</b> Instead of paying a 15% deposit, a 20% deposit was paid (R179 000).</p> <p><b>Effect:</b> Loan paid off in 197 months Total cost = <math>197 \times R7\,850,94</math> + R179 000,00 + R955,73 = R1 726 590,91 (a saving of R291 425,11)</p> <p><b>Graph:</b> The original loan is in blue and the higher deposit's effect is the dotted red line.</p> <p><b>Comment:</b> Due to the lower initial loan amount that graph decreases faster.</p> 
Interest Rate	<p>The lower the interest rate, the lower the amount of interest that is charged on the loan.</p> <p><b>Scenario:</b> The interest rate drops to 10,0% (due to lower interest rates).</p> <p><b>Effect:</b> Loan still paid off in 240 months, but monthly payment is less:</p>

## Finance (interest, banking, inflation)

	<p>Monthly payment = <math>760\,750,00 \div 1\,000 \times 9,65</math>  <math>= R7\,341,24</math></p> <p>Total cost = <math>240 \times R7\,341,24 + R132\,450,00 + R123,25</math>  <math>= R1\,896\,270,85</math> (a saving of R121 745,17)</p> <p><b>Graph:</b>                  The original loan is in blue and the higher deposit's effect is the dotted red line.</p> <p><b>Comment:</b>                  Although the time period is the same, the graph has a lower curve than the original and this means an overall saving over the life of the loan.</p> <p><b>Note:</b> The interest rate will very rarely stay the same over the course of a home loan. It frequently changes and so the monthly amount will change whenever the interest rate changes (but NOT the life of the loan).</p>
<p>Loan length and/or monthly repayments</p>	<p>The shorter the period of the loan, the shorter amount of time to earn interest.</p> <p><b>Scenario:</b>                  Life of the loan is changed from 20 to 15 years.</p> <p><b>Effect:</b>                  The life of the loan shortens and the monthly repayment increases.</p> <p>Monthly payment = <math>760\,750,00 \div 1\,000 \times 11,37</math>  <math>= R8\,649,73</math></p> <p>Total cost = <math>180 \times R8\,649,73</math>  <math>+ R132\,450,00</math>  <math>- R1\,395,42</math>  <math>= R1\,689\,805,98</math>                  (A saving of R328 210,04)</p> <p><b>Graph:</b>                  The original loan is in blue and the higher deposit's effect is the dotted red line.</p> <p><b>Comment:</b>                  The effect of decreasing the time period on the loan is effectively the same as increasing the monthly amount. The loan is paid off faster. Even though the monthly amount is larger, the total cost of the loan ends up being smaller.</p>





## 2. Investments

An investment is where money is paid into a fund which then gains interest and increases the value of the original money to the benefit of the investor. This is unlike the loan, where the interest is to the benefit of the bank or loan agent.

Interest is calculated on the closing balance of the account and paid into the investment on a monthly basis. In this way both the funds invested and the interest earned gather additional interest.

Two types of investments are analysed in the Learner's Book:

- Retirement annuities
- Stokvels

### 2.1. Retirement annuities

- Money is placed into a special fund.
- Every month a payment is made to this fund.
- The fund earns interest and it grows in a compound way.
- At a certain age (normally at age 65), the investor can draw a monthly payment as an income replacement in their retirement.

The table below shows a retirement investment where R400,00 per month is invested at a growth rate of 6% p.a.:

Retirement investment example					
Month	Opening Balance	Payment	Balance with payment	Interest Earned	Closing balance
1	R0,00	R400,00	R400,00	R2,00	R402,00
2	R402,00	R400,00	R802,00	R4,01	R806,01
---	---	---	---	---	---
360	R401 406,01	R400,00	R401 806,01	R2009,03	R403 815,04
---	---	---	---	---	---
479	R791 835,11	R400,00	R792 235,11	R3 961,18	R796 196,29
480	R796 196,29	R400,00	R796 596,29	R3 982,98	R800 579,27

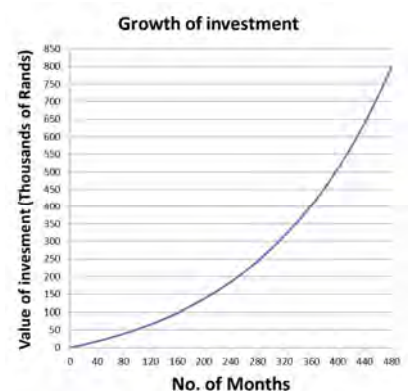

Note the following:

- The investment grew to R403 815,04 in the first 30 years (360 months). However, it almost doubled in value 10 years later. The effect of *compound interest* means that the size of the investment is *increasing at an increasing rate*. So the earlier you start saving the better!

## Finance (interest, banking, inflation)

- A total of R192 000,00 was invested over 40 years and it grew to R800 579,27. The value grew simply by investing it wisely.

### 2.2. Stokvels

- A group of people pool their money and make regular contributions to the pool.
- In a 'shared investment scheme' they then either share the pool (and the interest earned) amongst the members or they take turns to withdraw the whole pool (e.g. saving towards Christmas shopping or a holiday or home repair).
- Another type of stokvel is a 'shared buying scheme'. Here the group pools their money so that they can buy in bulk and qualify for savings on those bulk purchases (e.g. buying groceries at a trader's depot where goods are sold in large amounts only).
- Due to the short term nature of this type of investment there is not usually a large amount of interest earned. For higher interest amounts, the money would need to be invested for a much longer period of time.

## Section 2: Inflation

---

(LB pages 120-123)

### Overview

The content of this section on *Inflation*, as part of the Finance Application Topic, is drawn from page 58 in the CAPS document.

As stipulated in the CAPS document, Grade 12 learners need specifically to be able to:

- interpret and analyse graphs showing changes in the inflation rate over time and understand that a decreasing graph does not necessarily indicate negative inflation (deflation) or a decrease in price.
- critique situations involving proposed price increases (e.g. salary negotiations, school fee increases).

### Contexts and integrated content

- Learners need to be able to work in contexts relating to inflation (e.g. salary negotiations, school fee increases, etc.)
- Graphs are used as sources of information and a resource which needs to be critically analysed. Therefore the skills contained in the Patterns, relationships and representation basic skills topic will become necessary.

### 1. Making sense of graphs showing inflation rates

Inflation is the increase in the price of goods over time and is sometimes presented as graphs.

Remember the following points about calculating inflation:

- Inflation is calculated from January of one year to January of the next year.
- Inflation is reported backwards so to calculate the 2007 inflation rate, the values of 2006 and 2007 have to be used.
- The following calculation is used:

$$\% \text{ inflation} = \frac{\text{Change in price}}{\text{Original price}} \times 100$$

- Inflation is presented as a percentage in order to compare various years.

## Finance (interest, banking, inflation)

Consider the following two graphs which show how the price of bread has changed from 2006 to 2012.

### Prices of brown bread

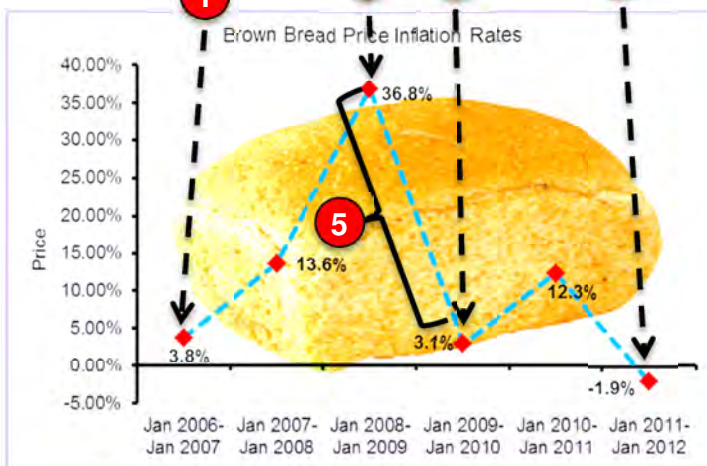
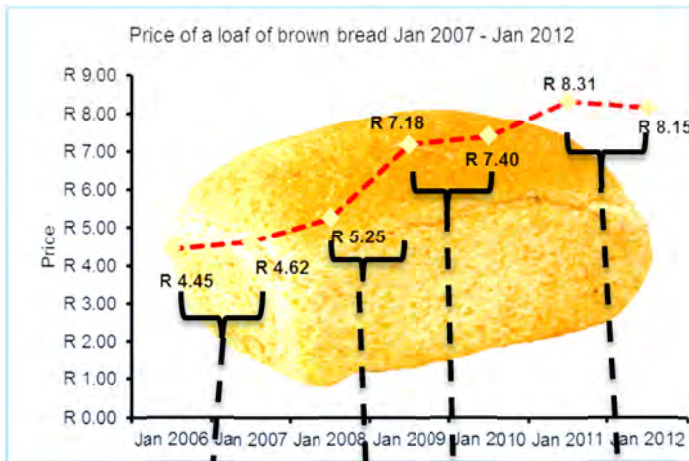

### Inflation rates of brown bread

### Notes

- 1 Inflation rate =  $\frac{(R4,62 - R4,45)}{R4,45} \times 100$   
 $= \frac{R0,17}{R4,45} \times 100$   
 $= 3,8\%$
- 2 **Largest increase in price**  
 Prices graph: steepest upward *slope*  
 Inflation graph: highest *value*
- 3 **Smallest increase in prices**  
 Prices graph: shallowest upward *slope*  
 Inflation graph: lowest *value*
- 4 **Decrease in prices**  
 Prices graph: *downward slope*  
 Inflation graph: *negative value*
- 5 **Downward slope on inflation graph**  
 This indicates that the *rate is decreasing* although the actual *price is still increasing* but at a *lower rate*.

## 2. Inflation rates inform salary negotiations

The reported inflation rate is calculated as an average increase for a total of 5 000 goods and services, not just one item (e.g. the price of brown bread is only one of the 5 000 items which is averaged).

## Finance (interest, banking, inflation)

## Example

A person earns R16 750,00 per month and has the following living expenses:

Expense Item	Previous monthly cost	Current monthly cost	Inflation
Transport (petrol)	R1 800,00	R2 300,00	27,78%
Groceries	R3 450,00	R3 600,00	4,35%
Medical Aid Insurance	R1 875,00	R2 062,00	9,97%
Car Insurance	R427,30	R427,30	0,00%
Electricity	R620,00	R660,00	6,45%
Clothing	R500,00	R580,00	16,00%
Accommodation rental	R3 200,00	R3 520,00	10,00%
<b>Total</b>	<b>R11 872,30</b>	<b>R13 149,30</b>	<b>10,76%</b>

This person will receive an annual salary increase of 7,5%. This is a little better than the national inflation rate (currently 6% p.a.). Has the financial position of this person stayed the same, improved or worsened?

**Answer:**

Salary increase = 7,5% of R16 750,00 = R1 256,25

Increase in living expenses = R13 149,30 – R11 872,30 = R1 277,00

Therefore we can say that the financial situation has remained approximately the same (the difference of R19,75 is not significant)

To cover the increased costs exactly, what percentage increase would this person actually need?

$$\begin{aligned}
 \text{Percentage Increase} &= \frac{\text{Increase}}{\text{Original Salary}} \times 100 \\
 &= \frac{R1\,277}{R16\,750} \times 100 \\
 &= 7,6\%
 \end{aligned}$$

**Notes:**

- The inflation of the expenses does not mean that the salary must increase by the same amount. Rather, it would depend on their *original salary*. For example, if their original salary was R15 000,00 then they would have needed an 8,5% increase to maintain their financial position.
- Inflation therefore affects poorer people worse than richer people.
- If all of the inflation percentages of the listed items were averaged  $((27,78\% + 4,35\% + 9,97\% + 0,0\% + 6,45\% + 16,0\% + 10,0\%) \div 7 = 10,65\%$  we see that this is different from the overall reported average of 10,76%. This is due to each item having a different starting total with some larger than the others.

## Additional questions

1. A person would like to buy the car alongside. The bank is offering a loan at the terms listed.
  - 1.1 Calculate the value of the deposit.
  - 1.2 Calculate the loan amount once the deposit has been taken into account.
  - 1.3 Using your answer from Question 1.2 and the following table of loan factors calculate the monthly payment.



Cash Price	R 132 180
Deposit	15%
Interest Rate	10,5%
Terms	60 months
Balloon Payment	None

Monthly payment = loan amount  $\div$  1 000  $\times$  loan factor

Factor values							
Loan Period	INTEREST RATE						
	10%	10.25%	10.50%	10.75%	11%	11,5%	12%
3 years	32,27	32,38	32,50	32,62	32,74	32,98	33,21
4 years	25,36	25,48	25,60	25,72	25,84	26,09	26,33
5 years	21,25	21,37	21,49	21,62	21,74	21,99	22,24
6 years	18,53	18,65	18,78	18,91	19,03	19,29	19,55

- 1.4 Using your answer to Question 1.3, calculate the total amount that will be paid to the bank for the car.
- 1.5 Using the answer to Question 1.4, calculate the total interest paid to the bank.

## Finance (interest, banking, inflation)

2. A person bought a house for R770 000,00 and obtained a home loan from a bank in order to pay for it. The loan period was 240 months. The progressive closing balance is shown in the graph below:

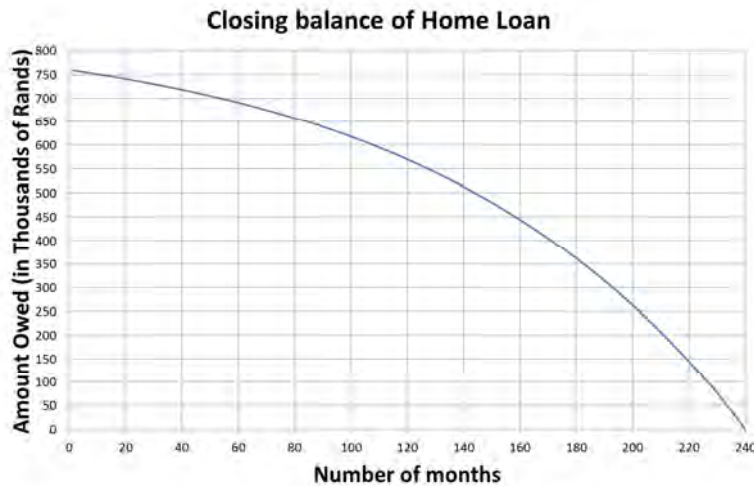

- 2.1 Why does the graph curve? (as opposed to being a straight line)
- 2.2 What would the graph look like if:
- 2.2.1 The amount borrowed was R450 000?
  - 2.2.2 The person had paid a deposit of R220 000?
  - 2.2.3 The person paid an extra R1 000 into the home loan every month?
  - 2.2.4 The interest rate (at which the money was borrowed) decreased by 2% p.a. after 60 months (but they still carried on paying the same monthly amount)?
3. The South African consumer price inflation was recorded as follows:
- 2007:** 7,6%    **2008:** 9,4%    **2009:** 6,0%    **2010:** 3,4%
- 3.1 Assuming that the price of computers increased according to inflation, calculate what a basic computer should have cost in 2010 if it cost R5 000 in 2006.
- 3.2 A basic computer actually cost R4 200 in 2010.
- 3.2.1 Does this mean that the inflation figures are wrong? Give a reason for your answer.
  - 3.2.2 Why did computer prices decrease over this period when food prices rose dramatically over the same period?

## Finance (interest, banking, inflation)

4. Below is a graph which shows the inflation rate for various years. Use it to answer the questions which follow:

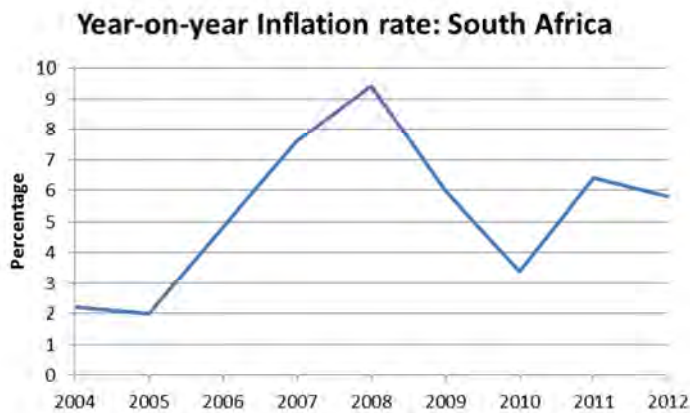

- 4.1 Felicia looks at the graph and says: “Prices dropped from 2008 to 2010”. She is incorrect. What is actually happening between 2008 and 2010?
- 4.2 What would the graph look like if there was an overall decrease in prices in a year?
- 4.3 Miriam received an annual increase of 6% in her salary every year from 2004 to 2008. She went on strike in 2008 for a greater increase. Why did she do this?



## Answers

- 1 1.1 15% of R132 180 = R19 827,00
- 1.2 Loan amount = cash price – deposit = R132 180 – R19 827 = R112 353
- 1.3 Loan factor = 21,49 (the value for 10,5% for 5 years)  
 Monthly amount =  $R112\,353 \div 1\,000 \times 21,49$   
 = R2 414,47
- 1.4 Total Amount = Deposit + Total of all monthly amounts + balloon payment  
 = R19 827 + R2 414,47 × 60 + R0  
 = R19 827 + R144 868,20 + R0  
 = R164 695,20
- 1.5 Interest = Total Amount paid – Cash amount  
 = R164 695,20 – R132 180  
 = R32 515,20

- 2 2.1 The amounts being deducted each month are not constant as would be the case with a straight line. Instead they are increasing monthly, hence the graph is getting steeper as it goes along.

- 2.2 2.2.1 It would start lower down, but it would still end 240 months later as the terms of the loan would still be 20 years. Like this:

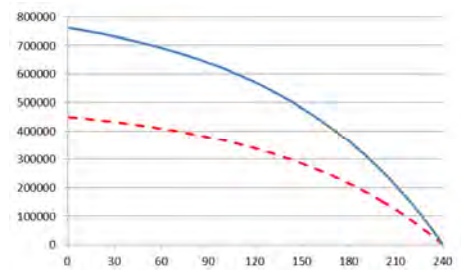

- 2.2.2 If they paid a deposit of R220 000, then the amount owed would be R550 000 and so the graph would look very similar to 2.2.1.

However, if they agreed to the terms and then in the first month they paid in an extra R220 000 then the graph would look like this (but only if they paid the original monthly instalments):

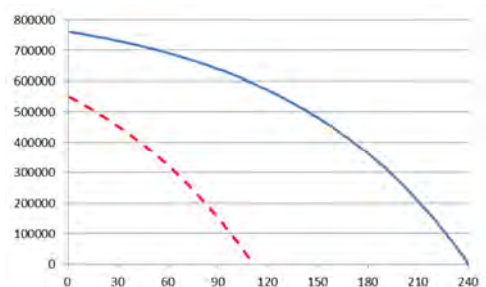

## Finance (interest, banking, inflation)

2.2.3 The graph would start from the same place, but it would decrease much faster, like this:

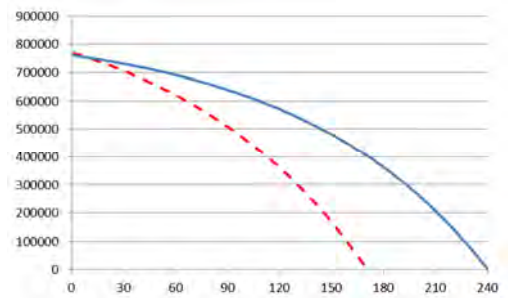

2.2.4 The new graph will follow the original graph until 60 months and then it will drop more steeply as the loan is being paid off faster than the bank's original calculated monthly amount.

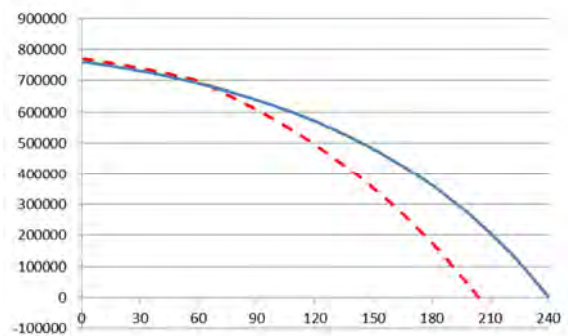

- 3 3.1 2006: R5 000  
 2007:  $R5\ 000 + 7,6\% \text{ of } R5\ 000 = R5\ 380$   
 2008:  $R5\ 380 + 9,4\% \text{ of } R5\ 380 = R5\ 885,72$   
 2009:  $R5\ 885,72 + 6,0\% \text{ of } R5\ 885,72 = R6\ 238,86$   
 2010:  $R6\ 238,86 + 3,4\% \text{ of } R6\ 238,86 = R6\ 450,98$
- 3.2 3.2.1 No. The inflation percentage is calculated on a basket of goods and not one single item. Some of the items in the basket of goods will increase while some will decrease in price.
- 3.2.2 The manufacturing cost of computers decreased over this time while food became more expensive to produce.
- 4 4.1 The *inflation rate* is decreasing during that time. This means that prices still increased, but at a lower rate than before.
- 4.2 The inflation rate would be negative and so the graph would register negative values.
- 4.3 In order for Miriam to maintain her standard of living, her increase in salary would need to be larger than the inflation rate. This was not the case.

## Section 1: Comparing travel options

---

(LB pages 128-137)

### Overview

The content of this section on *Comparing travel options*, as part of the Maps, plans and other representations of the physical world Application Topic, is drawn from pages 74-75 in the CAPS document.

As stipulated in the CAPS document, Grade 12 learners need specifically to be able to:

- determine the 'operating cost' of a vehicle using the fixed, running and operating cost tables distributed by the Automobile Association of South Africa.
- plan and cost trips using timetables, fare charts, distance charts and budgets.

### Contexts and integrated content

- There is integration of content from the Basic Skills Topic of *Patterns, relationships and representations* with respect to using equations.
- There is also integration with the Measurement Application Topic with respect to measuring length (km) and volume (ℓ).

## 1. Mode of transport #1: Car

### 1.1 Planning the route

Considerations that would need to be analysed when considering a route are:

- How far is the trip via various routes?
- How long might the trip take via various routes? A highway would take less time than gravel roads even if it were a longer distance.
- How many rest stops are available on the route for food, fuel and toilet breaks?
- Are there extra costs that might have to be paid (e.g. toll fees)?
- What time of day or night do you expect to arrive? (Will you arrive too late to book into the hotel?)
- Whether to split the journey over two days for convenience and for practical reasons. If so, then where would the accommodation be located?

### 1.2 Determining travel costs

Total travel costs include both the fixed costs (depreciation, licensing and other one-off costs) and running costs (fuel, tyres, maintenance).

#### Example

A car is traveling from Durban to Cape Town. Determine the total travel costs for that trip. The following information is needed:

<b>Purchase Price</b>	R125 000,00
<b>Distance travelled in a year</b>	26 000 km
<b>Engine Capacity</b>	1 600 cc
<b>Current fuel price</b>	R11,88 per litre
<b>Fuel type</b>	Petrol
<b>Distance from Durban to Cape Town</b>	1 663 km

Referring to the tables below (which appear in the Learner's Book on pages 123-124) we can calculate the fixed and running costs of a vehicle. The factors in the tables are all in **cents**.

Map and plans (scale and map work)

Fixed costs

	<10 000	10 001 to 15 000	15 001 to 20 000	20 001 to 25 000	25 001 to 30 000	30 001 to 35 000	35 001 to 40 000	>40 001
R50 001 - R75 000	237	158	119	96	81	71	63	57
R75 001 - R100 000	318	213	160	129	10	95	84	76
R100 001 - R125 000	344	230	173	147	118	103	92	83

Total Fixed costs for the journey = 118 c/km x 1 663 km  
 = 196 234 c  
 = R1 962,34

Running Costs

Engine Capacity (cc)	Running Costs Table - Petrol Vehicles		
	Averaged Running Cost (c/km) - All costs inclusive of VAT		
	Fuel	Maintenance	
	Petrol Factor	Service And Repair Costs (in cents)	Tyre Costs (in cents)
	<b>A</b>	<b>B</b>	<b>C</b>
< 1 300	6.62	17.18	8.98
1 301 - 1 500	7.39	19.76	13.10
1 501 - 1 800	8.03	22.73	16.70
1 801 - 2 000	9.24	24.25	22.00

Running costs = A x petrol price + B + C  
 = 8,03 x 1188 c + 22,73 + 16,70  
 = 95,3964 + 22,73 + 16,70  
 = 134,8264 c/km

Total running costs for the journey = 134,8264 c/km x 1663 km  
 = 224 216,3032 c  
 = R2 242,16

Leave all the decimal places *during* the calculation.

Only round off the **final answer**.

Total costs = Fixed costs + running costs  
 = R1 962,34 + R2 242,16  
 = R4 204,50

**Note:** This is the *actual* cost of the journey including wear and tear. Usually when a person uses a car they only consider the cost of petrol.

## 2. Mode of transport #2: Bus

Travelling by bus (or by train) utilises the skills outlined in Chapter 1. Travel by bus is a form of *mass transport* and as such it needs to be run according to a timetable (for organisation) and along limited routes (for affordability). Travelling by car is much more flexible, but also much more expensive (unless a group of people travels together and shares the cost of the petrol).

### Making sense of a bus timetable and fare table

#### Example

Using a bus, which would be the best way to travel from Johannesburg to Bloemfontein?

	From/To	Depart	Arrive	Full Flexi	Flexi	Saver	Notes
				What do these mean?			
1	Johannesburg To Bloemfontein Route: <i>Mainliner (Mid)</i> PTA - CPT	Tue 04 Dec 2012 12:00pm ZA	Tue 04 Dec 2012 18:00pm ZA	<input type="radio"/> 410.00	<input type="radio"/> 310.00	<input type="radio"/> 230.00	Direct Route
2	Johannesburg To Bloemfontein Route: <i>Sleepliner (EX)</i> PTA - CPT	Tue 04 Dec 2012 14:30pm ZA	Tue 04 Dec 2012 19:30pm ZA	<input type="radio"/> 450.00	<input type="radio"/> 380.00	<input type="radio"/> 260.00	Direct Route
3	Johannesburg To Bloemfontein Route: <i>Sleepliner</i> PTA - MOS	Tue 04 Dec 2012 15:30pm ZA	Tue 04 Dec 2012 21:10pm ZA	<input type="radio"/> 450.00	<input type="radio"/> 370.00	<input type="radio"/> 330.00	Direct Route
4	Johannesburg To Bloemfontein Route: <i>Sleepliner</i> PTA - PLZ	Tue 04 Dec 2012 16:00pm ZA	Tue 04 Dec 2012 21:50pm ZA	<input type="radio"/> 350.00	<input type="radio"/> 270.00	<input type="radio"/> 270.00	Direct Route
5	Johannesburg To Bloemfontein Route: <i>Sleepliner</i> PTA - CPT	Tue 04 Dec 2012 17:45pm ZA	Tue 04 Dec 2012 23:30pm ZA	<input type="radio"/> 440.00	<input type="radio"/> 310.00	<input type="radio"/> 310.00	Direct Route
6	Johannesburg To Bloemfontein Route: <i>Mainliner</i> PTA-EL	Tue 04 Dec 2012 18:30pm ZA	Wed 05 Dec 2012 00:10am ZA	<input type="radio"/> 410.00	<input type="radio"/> 320.00	<input type="radio"/> 230.00	Direct Route

Source: <http://www.intercape.co.za/bus-booking/johannesburg/to/bloemfontein/0/>

The above table is taken from the Intercap bus company booking site. It combines all three information tables into one (*route map, travel timetable and fare table*).

Ultimately the decision will be made according to three criteria:

- *Most convenient departure time*: All the times seem early enough in the day, although options 5 & 6 are in rush hour.
- *Most convenient arrival time*: Options 4, 5 & 6 arrive very late in the evening. Even option 3 is late for someone to come to pick you up from the bus stop.
- *Cost and availability of tickets*: Options 1 & 6 have the best prices and they seem to be available.

## Section 2: Compass directions

(LB pages 138-141)

### Overview

The content of this section on *Compass directions*, as part of the Maps, plans and other representations of the physical world Application Topic, is drawn from page 74-75 in the CAPS document.

As stipulated in the CAPS, Grade 12 learners need specifically to be able to:

- make sense of directions and signboards on roads and in map books that refer to compass directions (e.g. 'Travel North on the M3').
- interpret elevation plans of buildings that include the words 'North Elevation', 'South Elevation', 'East Elevation' and 'West Elevation'.
- inform decisions on where to position a house or a garden in relation to the position of the sun at different times of the day.

### Contexts and integrated content

- Contexts include any situation where a journey (on foot or in a vehicle) needs to be planned.

### Compass directions and applications

- There are four basic directions: North, South, East and West aligned at  $90^\circ$  to each other.
- Exactly halfway between the four basic directions (at  $45^\circ$  to each of the basic directions) are the secondary directions North East, South East, South West and North West. 'North West' means that it is exactly halfway between North and West.
- Compass directions can be used to indicate exact location when used in lines of latitude and longitude (e.g. Cape Town is at  $33^\circ 55' 31''\text{S}$ ,  $18^\circ 22' 26''\text{E}$ )
- Directions on major highways indicate the direction of travel to assist motorists in making the correct decision.
- Compass directions are used in construction to refer to the direction a building is facing (e.g. 'South Elevation' refers to the side that phases South, so a person looking at it from the outside would be facing North).
- In the Southern hemisphere, buildings are built with many rooms North-facing to get the most sun-exposure. The opposite is true in the Northern hemisphere.

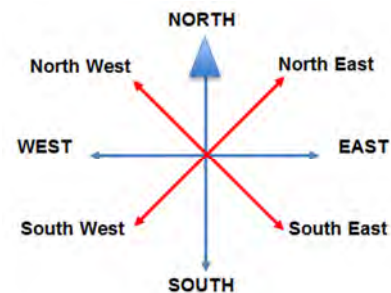

Knowing the direction of a road allows the motorist to be in the correct lane

## Section 3: Scale

---

(LB pages 142-145)

### Overview

The content of this section on *Scale*, as part of Maps, plans and other representations of the physical world Application Topic, is drawn from page 73 in the CAPS document.

As stipulated in the CAPS document, Grade 12 learners need specifically to be able to:

- calculate map and/or plan measurements when actual lengths and distances are known using a given scale to inform the drawing of 2-dimensional plans and pictures and the construction of 3-dimensional models.
- determine the most appropriate scale in which to draw/construct a map, plan and/or model, and use this scale to complete the task.
- determine the scale in which a map and/or plan has been drawn in the form  $1 : \dots$  and use the scale to determine other dimensions on the map and/or plan.

### Contexts and integrated content

- Determine contexts including any situation where a map or plan is used to determine distance.
- At times learners will be required to convert between different units which will draw on the skills found in the *Measurement* Application Topic.

Scale is referred to here and in Chapter 10. The contexts are different in the two chapters, but the skills are similar.



## Scale: Basics

- A scale has two sides to it: The left side always refers to a measurement on the **Map** (or Plan), while the right side always refers to the measurement in real life (**Actual** measurement). We can summarise this as the '**MA** rule' (Map-Actual).

**M    A**

1 : 30 000

- A scale does not have units as the units on both sides will be the same.

## Example

A scale of 1 : 30 000 means that 1 cm measured on the **Map** represents 30 000 cm in real life (**Actual**).

## Determining the equivalent number scale for a bar scale

To determine the number scale we need a measurement from the bar scale and the actual (real life) value of the *same measurement*. We then follow this procedure:

- Measure the bar scale and record both the bar scale and real life measurements in their correct places in the scale (**M : A**)
- Convert both measurements to *the same units*. Convert to the *smaller unit* for ease of calculation.
- Divide both by the **Map** value.

## Example

- In the bar scale alongside you can see that a measurement of 4 cm on the bar scale is equivalent to 20 km in real life

Therefore the scale is: 4 cm : 20 km

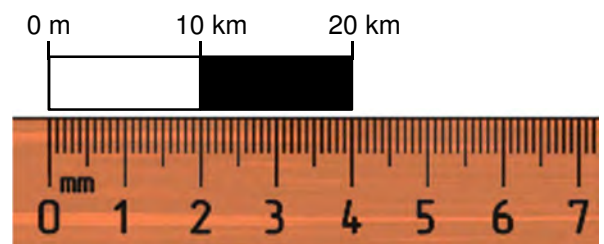

- 20 km = 2 000 000 cm, therefore if we write the measurements in the same units, we see that the scale is: 4 cm : 2 000 000 cm
- Divide both sides by the **Map** measurement (to get the Map side of the scale to be 1): 4 cm ÷ 4 cm = 1 and 2 000 000 cm ÷ 4 cm = 500 000, therefore the scale is: **1 : 500 000**

## Checking the accuracy of the number scale

The method that would be used would be the method outlined above and will be the same operation as the example below therefore we will not deal with it here.

## Determining the scale of a map

**Question:** Why can we NOT determine the scale by measuring a straight line from Kimberley to Trompsberg?

**Answer:** The real life distance between those two points is not known.

In order to calculate the scale of a map we require a measurement from the map and the actual value of the measurement. It is better to have two points which are in a straight line from each other, but if they are not, use a piece of string to get the approximate measurement on the map.

## Example

This is the same map as the one in the Learner's Book on page 144, to the same scale. To confirm this we measure the distance from Kimberley to Heuningneskloof (marked with red stars).

- 1 The measurement between the two points is approximately 2,4 cm and if we add up the distances indicated on the map we get  $20 + 16 + 22 = 58$  km. Therefore the scale is:  $2,4 \text{ cm} : 58 \text{ km}$
- 2  $58 \text{ km} = 5\,800\,000 \text{ cm}$ , therefore if we write the measurements in the same units, we see that the scale is:  
 $2,4 \text{ cm} : 5\,800\,000 \text{ cm}$
- 3 Divide both sides by the Map measurement (to get the Map side to 1):  $2,4 \text{ cm} \div 2,4 \text{ cm} = 1$  and  $5\,800\,000 \text{ cm} \div 2,4 \text{ cm} = 2\,416\,667$ , thus the scale is:  $1 : 2\,416\,667 \approx 1 : 2\,400\,000$



**Note:** There are several reasons why the scale is different to the textbook:

- The map distances cannot be measured to an appropriate degree of accuracy (e.g. it would be more accurate if the measurement was in mm or if we could zoom in and measure with greater skill).
- The real life distances are rounded off.
- We are finding an *approximate scale*. The map scale would be better.

## Additional questions

1. Hloni is a taxi owner. He operates a route that takes passengers from Norvalspunt to Bloemfontein and back again. He needs to know what to charge his passengers in order to make a decent profit.

His route takes him down the N1 and the section of the map alongside shows his start and end points (indicated by the red stars).

- 1.1 Calculate the total distance between the two points by adding up the blue numbers on the map. These indicate the distance (in km) between various points on the route.
  - 1.2 Hloni measures the distance between the two stars on a map as 12,4 cm. Use this distance and the answer to Question 1.1 to calculate the scale of the map alongside.
  - 1.3 The map alongside is taken from the map on the previous page. Explain why the scales of the maps are not the same.
  - 1.4 Is the scale of the map alongside larger or is it smaller than the map on the previous page? Give a reason for your answer.
2. In order to calculate the fixed and running costs of the vehicle he needs to work out the total distance that he will be driving in a year.
- 2.1 Using your answer to Question 1.1 calculate the total time it will take him to do one trip to Bloemfontein. He will be travelling at approximately 90 km/h on average and it will take him 15 minutes to get to the taxi rank once he arrives in Bloemfontein.
  - 2.2 He estimates that each trip will take him 2 hours. With loading, unloading and waiting for passengers, he calculates that he will be able to do 4 trips in a day (To Bloemfontein and back twice). He will operate for 320 days of the year. Calculate the total annual distance that he will drive.
3. Hloni drives a Toyota Quantum minibus. Its engine capacity is 2 700 cc and it cost R303 000 to buy. It is a petrol vehicle.
- 3.1 Use the following table to determine his Fixed Cost amount (in c/km):

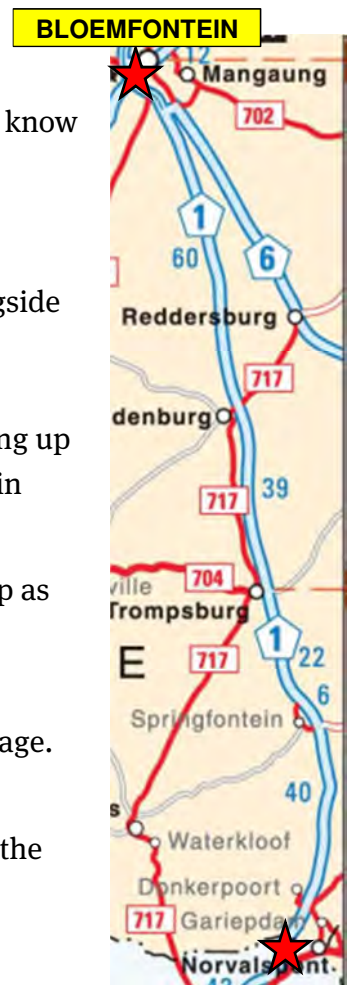

## Map and plans (scale and map work)

Purchase Price (Incl. VAT)	Fixed Costs Table							
	Averaged Fixed Cost (c/km) - All costs inclusive of VAT							
	Annual Distance Travelled							
	<10 000	10 001 to 15 000	15 001 to 20 000	20 001 to 25 000	25 001 to 30 000	30 001 to 35 000	35 001 to 40 000	>40 001
R200 001 - R250 000	704	470	354	286	240	211	187	169
R250 001 - R300 000	788	526	396	320	269	237	210	191
R300 001 - R350 000	927	619	466	377	317	279	247	224
R350 001 - R400 000	1067	713	536	434	365	321	285	258

- 3.2 Use the following table to work out his Petrol Factor (A), Service/Repair costs (B) and Tyre costs (C). All of the factors are in c/km.

Engine Capacity (cc)	Running Costs Table - Petrol Vehicles		
	Averaged Running Cost (c/km) - All costs inclusive of VAT		
	Fuel	Maintenance	
	Petrol Factor A	Service And Repair Costs (in cents) B	Tyre Costs (in cents) C
2 001 - 2 500	10.60	29.17	25.20
2 501 - 3 000	10.96	35.97	31.70
3 001 - 4 000	12.02	38.02	32.50
> 4 001	14.40	52.34	41.00

- 3.3 Petrol currently costs R11,88. Use this fact and your answers from Questions 3.1 and 3.2 to work out the Total Operating Vehicle Cost (TOVC) using the following equation:

$$TOVC = \text{Fixed Cost amount} + A \times \text{Fuel Price} + B + C$$

- 3.4 He rounds off the TOVC amount to R4,20 / km. Using this value he calculates that his operating costs to travel to Bloemfontein will be approximately R700. Show how this was calculated.
- 3.5 Hloni takes an average of 12 passengers on each trip. He aims to make 30% profit. How much should he charge each passenger (use R700 as the operating cost of the vehicle)?

## Answers

---

- 1 1.1 They total 167 km.
- 1.2 Map : Actual  
 12,4 cm : 16 700 000 cm (Both measurements need to be converted to the same units)
- 1 : 1 346 774 (16 700 000 ÷ 12,4)
- 1 : 1 350 000 (Rounded off to the nearest sensible round number)
- 1.3 This map is enlarged.
- 1.4 It is larger: the smaller the number of the scale, the larger the scale.
- 2 2.1  $167 \text{ km} \div 90 \text{ km/h} = 1,86 \text{ hours} = 1 \text{ hour } 51 \text{ minutes} + 15 \text{ minutes}$   
 $= 2 \text{ hrs } 6 \text{ mins}$
- 2.2  $167 \text{ km} \times 4 \text{ trips/day} \times 320 \text{ days} = 213 760 \text{ km}$
- 3 3.1 224 c/km (His vehicle falls in the R300 001-R350 000 bracket and he travels more than 40 000 km per year.)
- 3.2  $A = 10,96$   
 $B = 35,97$   
 $C = 31,70$  (His vehicle is in the 2 501-3 000 cc bracket.)
- 3.3  $\text{TOVC} = 224 + 11,88 \times 10,96 + 35,97 + 31,70$   
 $= 224 + 103,20 + 35,97 + 31,70$   
 $= 421,87 \text{ c/km}$
- 3.4  $\text{R}4,20 / \text{km} \times 167 \text{ km} = \text{R}701,4 \approx \text{R}700$
- 3.5  $\text{R}700 \div 12 = \text{R}58,33 + 30\% \text{ of } \text{R}58,33 = \text{R}75,83 \approx \text{R}75$   
 This will be a nice round number. A side note is that this is too high a figure for the average person to pay so Hloni is going to have to charge less and maintain his vehicle less. This is why long-haul taxis are often not roadworthy. They cover too long a distance for too little money.

## Measurement (measuring and calculating lengths, perimeter, area and volume)

### Section 1: Measuring

(LB pages 162-165)

#### Overview

The content of this section, as part of the *Measurement* Application Topic, is drawn from page 64 in the CAPS document.

As stipulated in the CAPS document, Grade 12 learners need specifically to be able to:

- estimate lengths and /or measure lengths of objects accurately to complete tasks.
- determine the appropriateness of estimation for a given context/problem.

#### Contexts and integrated content

Learners need to be able to work in the context of larger projects that take place in the household, school or wider community.

In the next section, formal methods are used for calculating perimeter, area and volume; however it is always important to have a method for checking how sensible an answer is. The following two sub-sections outline methods for estimating lengths, distances, area and volume.

### 1. Measuring lengths and distances

The following body measurements could be used to estimate basic lengths and distances:

Indigenous methods of measurement		
Measurement	Description	Approximate length
Cubit	From the tip of the outstretched hand to the elbow	ψ m (actually 47 cm)
Hand	The width across all 5 fingers of the hand	10 cm
Digit	The width across the knuckle of the middle finger	2 cm
Pace	One good-sized step	1 m (actually 90 cm)
Foot	The length of an average foot	30 cm

There are also other common measurements that most people are familiar with that can be used to check how sensible an answer is.

## Measurement (measuring and calculating lengths, perimeter, area and volume)

### Example

A standard soccer pitch can have the following dimensions:

1. Calculate the total perimeter of the soccer pitch.

**Answer:**  $100\text{ m} + 80\text{ m} + 100\text{ m} + 80\text{ m}$   
 $= 360\text{ m}$

2. A learner was asked to calculate the length of fencing around the perimeter of his school and his answer was 250 m.

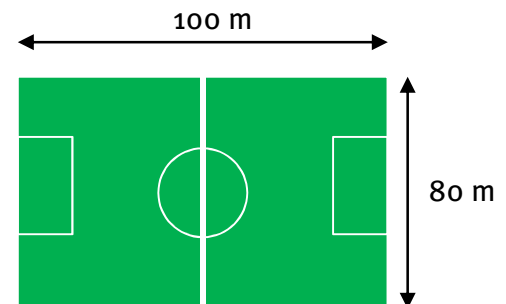

Referring to the dimensions of the soccer pitch, does this answer make sense?

**Answer:** No this does not make sense. A soccer pitch has a total perimeter of 360 m and his answer is smaller than this. It would have to be a really small school in order for this to be true.

### Measuring area and volume

Area refers to two dimensions being multiplied by each other while volume refers to three dimensions multiplied together.

The previous measurement estimates can be used to estimate area and volume as well:

## Measurement (measuring and calculating lengths, perimeter, area and volume)

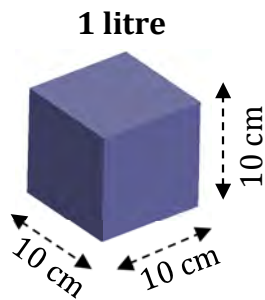

### Estimating Volume

$$\begin{aligned}
 1 \text{ litre} &= 1000 \text{ cm}^3 \\
 &= 10 \text{ cm} \times 10 \text{ cm} \times 10 \text{ cm} \\
 &= 1 \text{ hand} \times 1 \text{ hand} \times 1 \text{ hand}
 \end{aligned}$$

### Estimating Area

$$\begin{aligned}
 1 \text{ square metre} &= 1 \text{ m}^2 \\
 &= 1 \text{ m} \times 1 \text{ m} \\
 &= 1 \text{ pace} \times 1 \text{ pace} \\
 \text{or} &= 2 \text{ cubits} \times 2 \text{ cubits}
 \end{aligned}$$

### 1 square meter

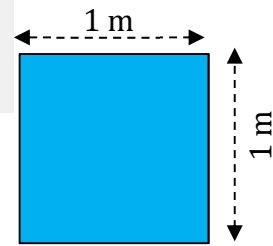

### Example

Is it incorrect to estimate the area of the ceiling of a normal classroom to be  $10 \text{ m}^2$ ?

**Answer:** Yes, it is incorrect. Even a small classroom would be approximately 4 paces by 5 paces. This would be an area of  $20 \text{ m}^2$ .



## Section 2: Calculating perimeter, area and volume

(LB pages 166-177)

### Overview

The content of this section, as part of the *Measurement Application Topic*, is drawn from pages 68-69 in the CAPS document.

As stipulated in the CAPS document, Grade 12 learners need specifically to be able to:

- Calculate the perimeter, area and volume of rectangles, triangles, circles, rectangular prisms, cylinders of known formulae as well as objects that can be decomposed into those shapes
- Calculating the cost of materials to complete a project.

### Contexts and integrated content

- Learners need to be able to work in the context of larger projects that take place in the household, school or wider community.
- Analysis and interpretation of plans is a skill that is required for success in this section. This involves the *Maps, plans and other representations of the physical world Application Topic*.

### Calculations involving perimeter

Perimeter is the length around the outside of a figure. Normally we only look at 2-dimensional figures, however the concept of total length can also apply to 3-dimensional figures which have a framework as well as any covering which will be attached to that framework.

### Example

Consider the metal archway alongside.

1. Metal is sold in 6m lengths. How many lengths will need to be purchased to make the archway alongside?

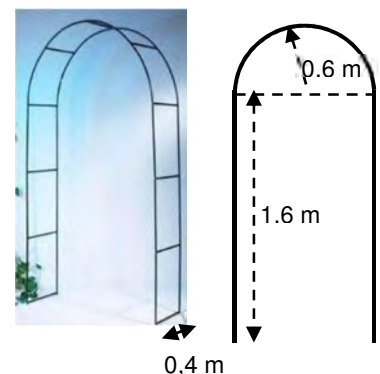

## Measurement (measuring and calculating lengths, perimeter, area and volume)

**Answer:**

Break the complicated figure down into more manageable pieces and then calculate the total:

$$\begin{aligned}
 \text{Total frame} &= 2 \times \text{[Semicircle]} + 2 \times \text{[Horizontal Line]} + 11 \times \text{[Vertical Line]} \\
 &= 2 \times \left(\frac{1}{2} \times \pi \times \text{diameter}\right) + 4 \times 1,6 \text{ m} + 11 \times 0,4 \text{ m} \\
 &= 2 \times (0,5)(3,14)(1,2 \text{ m}) + 6,4 \text{ m} + 4,4 \text{ m} \\
 &= 3,768 \text{ m} + 6,4 \text{ m} + 4,4 \text{ m} \\
 &= 14,57 \text{ m}
 \end{aligned}$$

Therefore 3 lengths of steel bar will need to be purchased to create the archway.

2. The steel frame is going to be covered with wooden tiles that are 20 cm wide and overlap each other by 3 cm as in the diagram alongside. How many will be required to cover the outside of the frame?

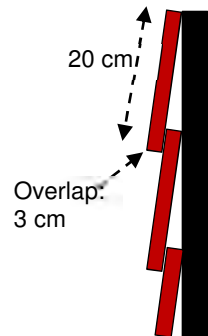

**Answer:**

The total outside length to be covered needs to be calculated first:

Total length of the front of the frame:

$$\begin{aligned}
 &\text{[Semicircle]} + 2 \times \text{[Horizontal Line]} \\
 &= \left(\frac{1}{2} \times \pi \times \text{diameter}\right) + 2 \times 1,6 \text{ m} \\
 &= (0,5)(3,14)(1,2 \text{ m}) + 3,2 \text{ m} \\
 &= 1,88 \text{ m} + 3,2 \text{ m} \\
 &= 5,08 \text{ m}
 \end{aligned}$$

Because they overlap, the width of the tile cannot be used as it is. The overlap of

## Measurement (measuring and calculating lengths, perimeter, area and volume)

adjacent tiles needs to be taken into account in order to use the *effective width* of the tiles:

$$\text{Effective Width} = 20 \text{ cm} - 3 \text{ cm} = 17 \text{ cm}$$

$$\text{No. of tiles needed} = \text{Total length} \div \text{Effective width}$$

$$= 508 \text{ cm} \div 17 \text{ cm} \quad (\text{Note that the units } \textit{must be the same})$$

$$= 29,88 \text{ tiles}$$

$$\approx \mathbf{30 \text{ tiles}}$$

### Calculations involving area

Most complex areas can be broken down into simpler areas. Once a larger area is calculated, other calculations can be performed on it such as seeing how many of a smaller area can fit into it.

#### Example

Skateboarders often enjoy performing tricks on a special ramp called a halfpipe (shown alongside).

1. Use the diagrams alongside to calculate the area of the curved skating surface of the halfpipe.

#### Answer:

If a surface has the same width all along its length, it then forms a large rectangle, so we can calculate the length of the edge and use it as the length of the rectangle:

$$\text{Total length of the edge} = 2 \times \frac{1}{4} \times \pi \times d + 3,6 \text{ m}$$

$$= 2 \times (0,25) \times (3,142) \times (5,48 \text{ m}) + 3,6 \text{ m}$$

$$= 8,61 \text{ m} + 3,6 \text{ m}$$

$$= 12,21 \text{ m}$$

Therefore total area of ramp surface = length  $\times$  breadth

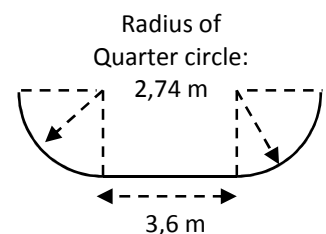

## Measurement (measuring and calculating lengths, perimeter, area and volume)

$$= 12,21 \text{ m} \times 13 \text{ m}$$

$$= 158,73 \text{ m}^2$$

2. A special board is used on the surface. The board is sold in rectangular pieces (width: 1,5 m, length: 3,0 m). Use the area of the board to *estimate* the number of boards needed to cover the skate surface of this halfpipe.

### Answer:

We can only *estimate* the number of boards as we would need to check how the boards fit together, but an estimate is useful when getting a rough idea of how many boards might be needed:

We can estimate the number of boards by dividing the area of one board into the total area of the ramp:

$$\text{Area of 1 board} = \text{length} \times \text{breadth} = 1,5 \text{ m} \times 3,0 \text{ m} = 4,5 \text{ m}^2$$

$$\text{Number of boards} = \text{Total area} \div \text{Area of 1 board}$$

$$= 158,73 \text{ m}^2 \div 4,5 \text{ m}^2 = 35,27 \text{ boards} \approx \mathbf{36 \text{ boards needed.}}$$

## Calculations involving volume

Volume is the amount of 3-dimensional space inside a shape. If the shape is a prism we can use the area of the end to calculate the volume. We can use the following formula:

$$\text{Volume of a prism} = \text{Area of base} \times \text{height}$$

### Example

The refuse skip in the picture below is 1,75 m wide and its other dimensions are shown in the diagram alongside it.

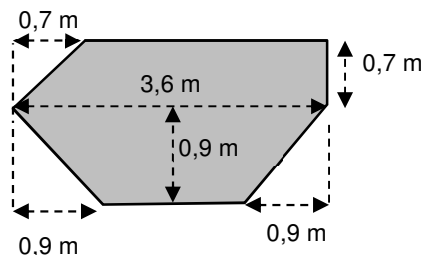

### Prism

A 3-dimensional shape that has the same shape (and size) on both ends and the same thickness along the entire shape.

## Measurement (measuring and calculating lengths, perimeter, area and volume)

1. Calculate the volume of the skip in  $\text{m}^3$ .

### Method 1: Using the formula

In order to calculate the area, it will need to be split up into smaller pieces:

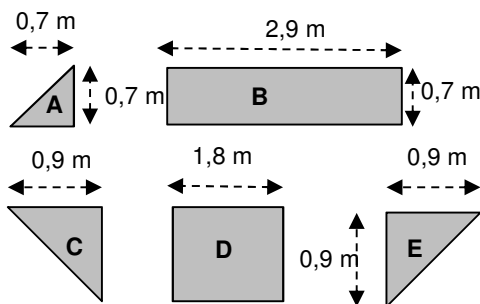

$$\text{Area A} = 0,5 \times 0,7 \text{ m} \times 0,7 \text{ m}$$

$$= 0,245 \text{ m}^2$$

$$\text{Area B} = 2,9 \text{ m} \times 0,7 \text{ m}$$

$$= 2,03 \text{ m}^2$$

$$\text{Area C} = 0,5 \times 0,9 \text{ m} \times 0,9 \text{ m}$$

$$= 0,405 \text{ m}^2$$

$$\text{Area D} = 1,8 \text{ m} \times 0,9 \text{ m}$$

$$= 1,62 \text{ m}^2$$

$$\text{Area E} = \text{Area C} = 0,405 \text{ m}^2$$

$$\text{Total Area of base} = 0,245 + 2,03 + 0,405 + 1,62 + 0,405 = 4,705 \text{ m}^2$$

$$\text{Volume} = \text{Area of base} \times \text{height}$$

$$= 4,705 \text{ m}^2 \times 1,75 \text{ m}$$

### Method 2: Splitting up the volume

The shape can be split up into different, smaller volumes:

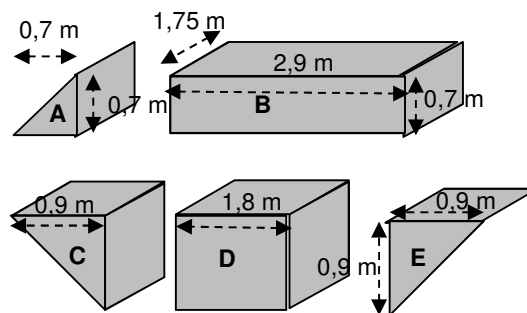

Each smaller volume has the same thickness (or width): 1,75 m.

$$\text{Volume A} = 0,5 \times 0,7 \text{ m} \times 0,7 \text{ m} \times 1,75 \text{ m}$$

$$= 0,42875 \text{ m}^3$$

$$\text{Volume B} = 0,7 \text{ m} \times 2,9 \text{ m} \times 1,75 \text{ m}$$

$$= 3,5525 \text{ m}^3$$

$$\text{Volume C} = 0,5 \times 0,9 \text{ m} \times 0,9 \text{ m} \times 1,75 \text{ m}$$

$$= 0,70875 \text{ m}^3$$

$$\text{Volume D} = 0,9 \text{ m} \times 1,8 \text{ m} \times 1,75 \text{ m}$$

$$= 2,835 \text{ m}^3$$

$$\text{Volume E} = \text{Volume C} = 0,70875 \text{ m}^3$$

$$\text{Total volume} = 8,23375 \text{ m}^3$$

## Measurement (measuring and calculating lengths, perimeter, area and volume)

$= 8,23 \text{ m}^3$ (Note: The 'height' is actually the 'thickness' of the prism)	$= 8,23 \text{ m}^3$ (Note: The volume of each segment is only rounded off at the end.)
---	--

Notice that either method can be used to get the same answer. Simply use the method that you are most comfortable with.

2. Approximately how many rubbish bags should be able to fit into the above skip if a normal rubbish bag can hold 120 ℓ of refuse?  $1 \text{ m}^3 = 1\,000 \text{ ℓ}$ .

**Answer:**

$$\text{Volume of skip} = 8,23 \text{ m}^3 \times 1\,000 = 8\,230 \text{ ℓ}$$

$$\text{No. of rubbish bags} = 8\,230 \text{ ℓ} \div 120 \text{ ℓ} = 68,58 \text{ bags} \approx 69 \text{ bags.}$$

However, the skip will be able to hold a lot more than that number as the bags are usually not totally filled with trash and so more will be able to fit in.

## Measurement (measuring and calculating lengths, perimeter, area and volume)

### Additional questions

The following formulas might be useful in the questions which follow:

$$\text{Area of rectangle} = l \times b \quad \text{Area of triangle} = \frac{1}{2} \times b \times h \quad \text{Area of circle} = \pi \times r^2$$

$$\text{Theorem of Pythagoras: } a^2 = b^2 + c^2 \quad \text{Perimeter of circle} = 2 \times \pi \times r$$

$$\text{Volume of prism} = \text{Area of base} \times \text{length of prism}$$

$$\text{Surface Area of closed prism} = 2 \times \text{Area of base} + \text{perimeter of base} \times \text{length of prism}$$

1. A man wants to extend his driveway to the sides to create some new parking areas. He is going to remove the grass that is already there and put down stones.

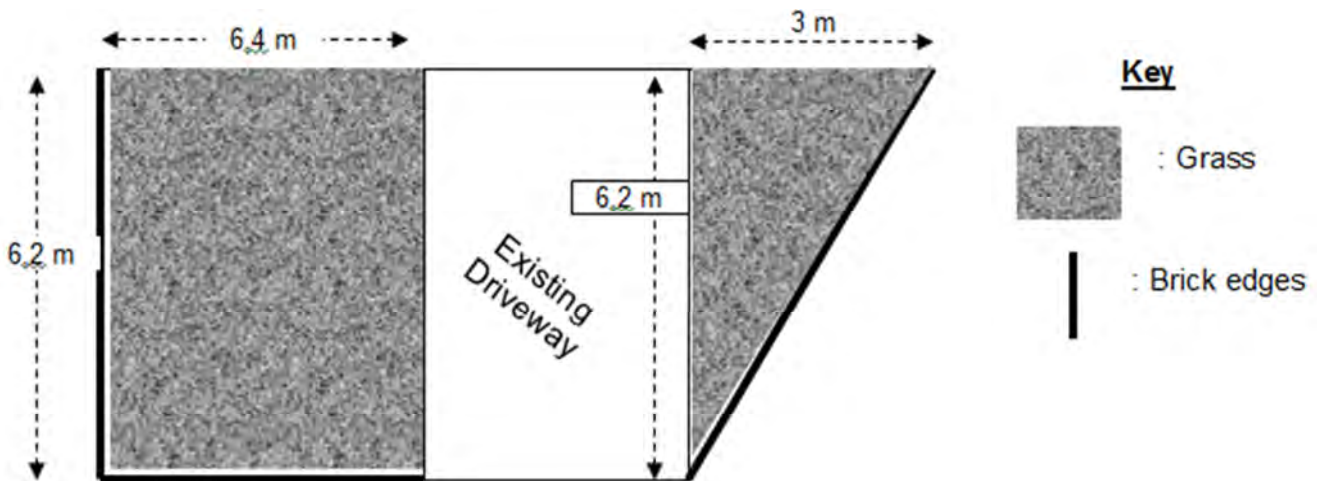

- 1.1 Firstly, he has to remove the grass and replant it in other areas of his yard. Calculate the total area of grass that will be removed from both areas. You may choose to use some of the formulas above.
- 1.2 He will then put down stones to a depth of 5 cm. Stone is sold in units of 0,5 cubic metres ( $\text{m}^3$ ). Use your answer to Question 1.1 to work out how many whole units of 0,5  $\text{m}^3$  of stone he will need to buy.
- 1.3 To keep the stones in position he is going to lay some bricks along the edges marked in bold. The other edges are next to the house or bordering on the existing driveway and will not require bricks.
  - 1.3.1 Calculate the total length of all the edges where he is going to lay bricks. (Hint: you will need to use the Theorem of Pythagoras.)
  - 1.3.2 Each brick is 22 cm long. How many bricks is he going to lay along the given edges?

## Measurement (measuring and calculating lengths, perimeter, area and volume)

- 1.4 Using your answers to Questions 1.2 and 1.3.2 calculate the total amount that this project is going to cost. Each unit of stone (per  $0,5 \text{ m}^3$ ) costs R280,00 and each brick costs R2,00.
2. A woman is planning to establish a vegetable garden in the corner of her property. It has the following shape:

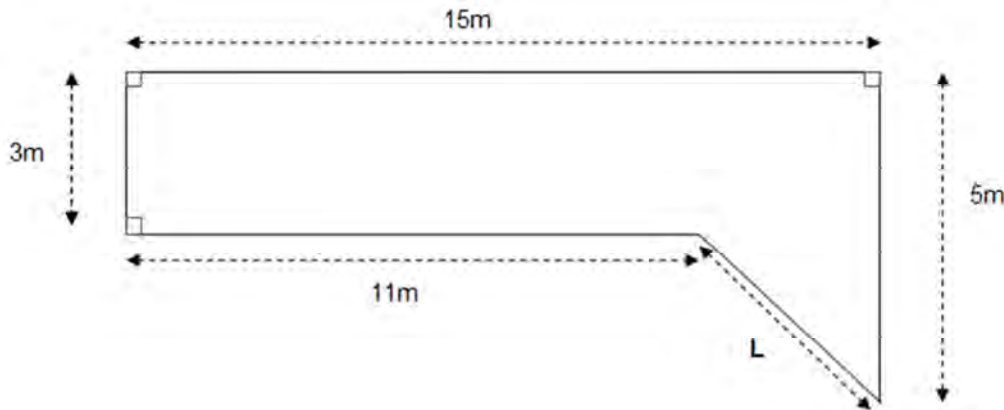

- 2.1 Using the formulas given at the start of these questions calculate the total area of the vegetable garden.
- 2.2 She is going to cover the area with compost. Each bag of compost will cover  $15 \text{ m}^2$ . Use your answer in Question 2.1 to work out how many bags of compost she must buy.
- 2.3 She is going to put up fencing around the perimeter of the garden. The fencing that she is planning to buy is sold in rolls that are 5 m long. To ensure that the fence encloses the area well, she will be overlapping the sections of fencing by 20 cm on each end like this:

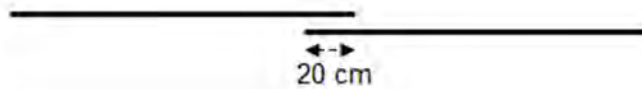

- 2.3.1 Calculate the length marked 'L' on the diagram using the Theorem of Pythagoras.
- 2.3.2 The length of 1 roll of fencing is 5 m. However, due to the overlap of each section, what is the *effective length* of each roll of fencing? Answer in m.
- 2.3.3 Using your two previous answers, calculate how many rolls of fencing will need to be bought to surround the vegetable patch.



Measurement (measuring and calculating lengths, perimeter, area and volume)

3. A man is remodelling his garden and decides to create a simple swimming pool. He plans to dig a rectangular hole and line it with spray-on cement.

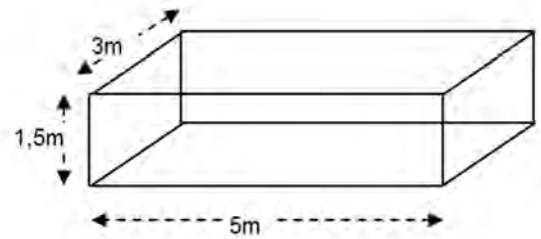

- 3.1 Use the measurements in the diagram alongside to calculate the surface area that will need to be covered by the spray-on cement.



- 3.2 During the winter, he plans to pump all of the water from the pool into a storage tank (such as the one in the picture alongside).

The large storage tank can hold 5 000 ℓ of water. If a full tank was emptied into his pool, how high would the water level be? Answer in m. (1 m<sup>3</sup> = 1 000 ℓ)

4. Swimming pools come in many different shapes and sizes. A homeowner wants to place a swimming pool in the garden. The homeowner decides on the following pool design (drawing NOT to scale):

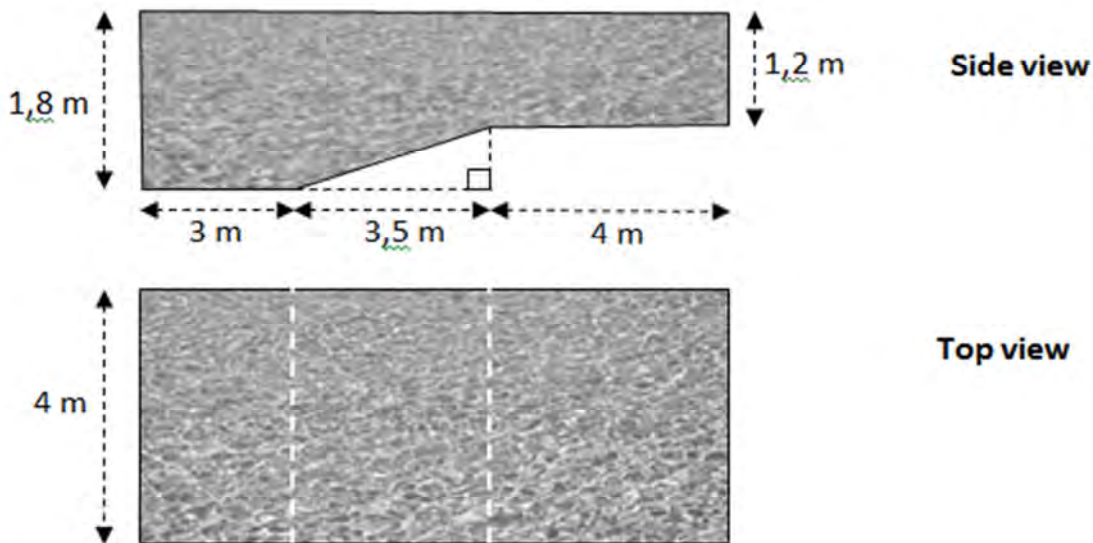

- 4.1 Calculate the volume of water that the pool can hold. Give your answer in m<sup>3</sup>.
- 4.2 The homeowner guesses that it is going to cost 'a few thousand Rand' to fill the pool for the first time. Is he or she correct? (Water costs 0,92 c/ ℓ and 1 m<sup>3</sup> = 1 kl)
- 4.3 A bed of compressed sand (10 cm thick) is laid underneath the pool to cushion it.

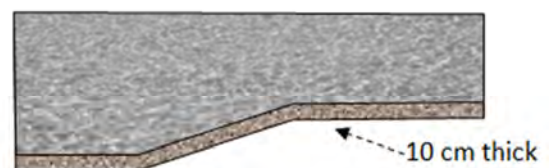

## Measurement (measuring and calculating lengths, perimeter, area and volume)

- 4.3.1 Calculate the surface area of the bottom of the pool (only the bottom, NOT the sides). Answer in  $\text{m}^2$ .
- 4.3.2 Sand is sold at a price of R375 per  $\text{m}^3$ . You can also purchase decimal amounts (e.g.  $1,325 \text{ m}^3$  or  $1,78 \text{ m}^3$ , etc.). Calculate the total cost of the sand required for the bed of compressed sand.

## Answers

- 1 1.1 Rectangular area =  $6,4 \text{ m} \times 6,2 \text{ m} = 39,68 \text{ m}^2$   
 Triangular area =  $\frac{1}{2} \times 6,2 \text{ m} \times 3 \text{ m} = 9,3 \text{ m}^2$   
 Total area =  $39,68 \text{ m}^2 + 9,3 \text{ m}^2 = 48,98 \text{ m}^2$
- 1.2 Volume of stone = Area of top  $\times$  depth of stone  
 =  $48,98 \text{ m}^2 \times 0,05 \text{ m}$  (this needs to be in m)  
 =  $2,449 \text{ m}^3$
- No. of units of stone =  $2,449 \text{ m}^3 \div 0,5 \text{ m}^3 = 4,898 \text{ units} \approx 5 \text{ units}$
- 1.3 1.3.1 Edge of the triangle is the hypotenuse of a right-angled triangle:  
 Length =  $\sqrt{(3)^2 + (6,2)^2}$   
 =  $\sqrt{9 + 38,44}$   
 =  $\sqrt{47,44}$   
 =  $6,89 \text{ m}$
- Edges of rectangle =  $6,4 \text{ m} + 6,2 \text{ m} = 12,6 \text{ m}$   
 Total length to be covered =  $12,6 \text{ m} + 6,89 \text{ m} = 19,49 \text{ m}$
- 1.3.2 One brick =  $22 \text{ cm} = 0,22 \text{ m}$   
 No. of bricks =  $19,49 \text{ m} \div 0,22 \text{ m} = 88,59 \text{ bricks} \approx 90 \text{ bricks}$
- 1.4 Stone =  $5 \text{ units} \times \text{R}280,00 = \text{R}1\,400,00$   
 Bricks =  $90 \times \text{R}2,00 = \text{R}180,00$   
 Total =  $\text{R}1\,400,00 + \text{R}180,00 = \text{R}1\,580,00$
- 2 2.1 The area can be split up into a long rectangle and a triangle:  
 Area of rectangle =  $15 \text{ m} \times 3 \text{ m} = 45 \text{ m}^2$   
 Area of triangle =  $\frac{1}{2} \times 2 \text{ m} \times 4 \text{ m}$  (worked out by subtracting lengths)  
 =  $4 \text{ m}^2$
- Total area =  $45 \text{ m}^2 + 4 \text{ m}^2 = 49 \text{ m}^2$
- 2.2 Bags of compost =  $49 \text{ m}^2 \div 15 \text{ m}^2/\text{bag}$   
 =  $3,27 \text{ bags} \approx 4 \text{ bags}$  (although by spreading it a bit thinly,  
 you could get by with 3 bags)
- 2.3 2.3.1 Length =  $\sqrt{4^2 + 2^2}$   
 =  $\sqrt{16 + 4}$   
 =  $\sqrt{20}$   
 =  $4,47 \text{ m}$

## Measurement (measuring and calculating lengths, perimeter, area and volume)

2.3.2  $5 \text{ m} - 0,2 \text{ m} = 4,8 \text{ m}$  (we only count the overlap on one end).

$$\begin{aligned} 2.3.3 \text{ Total length of fence} &= 4,47 \text{ m} + 5 \text{ m} + 15 \text{ m} + 3 \text{ m} + 11 \text{ m} \\ &= 38,47 \text{ m} \end{aligned}$$

$$\text{No. of rolls of fencing} = 38,47 \div 4,8 \text{ m} = 8,01 \text{ rolls}$$

We can consider this as 8 rolls exactly because we can move the overlap a little to accommodate the shortfall.

- 3 3.1 We will only consider those areas that need to be covered. These are all sides except the top side (as the water will be open in the pool).

$$\begin{aligned} \text{Total surface area} &= 2 \times 5 \text{ m} \times 1,5 \text{ m} + 2 \times 1,5 \text{ m} \times 3 \text{ m} + 5 \text{ m} \times 3 \text{ m} \\ &= 15 \text{ m}^2 + 9 \text{ m}^2 + 15 \text{ m}^2 \\ &= 39 \text{ m}^2 \end{aligned}$$

3.2  $5\,000 \text{ l} = 5 \text{ m}^3$

Volume = Area of base  $\times$  height

$$5 \text{ m}^3 = 5 \text{ m} \times 3 \text{ m} \times \text{height}$$

$$5 \text{ m}^3 = 15 \text{ m}^2 \times \text{height}$$

$$0,33 \text{ m} = \text{height}$$

(So the water in that large tank will only fill the pool up to 33 cm. the pool itself holds 22 500 l or  $4 \frac{1}{2}$  tanks of water!)

- 4 4.1 The volume can be divided up into various parts: 3 rectangular prisms and a triangular prism.

$$\begin{aligned} \text{Volume of rectangular prism 1} &= \text{Area of end} \times \text{length of prism} \\ &= 1,8 \text{ m} \times 3 \text{ m} \times 4 \text{ m} \\ &= 21,6 \text{ m}^3 \end{aligned}$$

$$\begin{aligned} \text{Volume of rectangular prism 2} &= 1,2 \text{ m} \times 3,5 \text{ m} \times 4 \text{ m} \\ &= 16,8 \text{ m}^3 \end{aligned}$$

$$\begin{aligned} \text{Volume of rectangular prism 3} &= 1,2 \text{ m} \times 4 \text{ m} \times 4 \text{ m} \\ &= 19,2 \text{ m}^3 \end{aligned}$$

$$\begin{aligned} \text{Volume of triangular prism} &= \frac{1}{2} \times 3,5 \text{ m} \times 0,6 \text{ m} \times 4 \text{ m} \\ &= 4,2 \text{ m}^3 \end{aligned}$$

$$\begin{aligned} \text{Total volume} &= 21,6 + 16,8 + 19,2 + 4,2 \\ &= 61,8 \text{ m}^3 \end{aligned}$$

4.2  $61,8 \text{ m}^3 = 61\,800 \text{ l}$

$$\text{Total cost} = 0,92 \text{ c/l} \times 61\,800 \text{ l} = 56\,856 \text{ c} = \text{R}568,56$$

So, although it is not cheap, it is also not 'a few thousand rand'.

**Measurement (measuring and calculating lengths,  
perimeter, area and volume)**

4.3 4.3.1 Sloped length will need the theorem of Pythagoras:

$$\begin{aligned}\text{Length} &= \sqrt{(0,6)^2 + (3,5)^2} \\ &= \sqrt{0,36 + 12,25} \\ &= \sqrt{12,61} \\ &= 3,55 \text{ m}\end{aligned}$$

$$\text{Total length of side of pool} = 3 \text{ m} + 3,55 \text{ m} + 4 \text{ m} = 10,55 \text{ m}$$

Area of bottom = length of side  $\times$  width

$$\begin{aligned}&= 10,55 \text{ m} \times 4 \text{ m} \\ &= 42,2 \text{ m}^2\end{aligned}$$

4.3.2 Volume of sand = Area  $\times$  depth

$$\begin{aligned}&= 42,2 \text{ m}^2 \times 0,1 \text{ m} \\ &= 4,22 \text{ m}^3\end{aligned}$$

Cost of sand =  $4,22 \text{ m}^3 \times \text{R}375/\text{m}^3$

$$= \text{R}1\,582,50$$

## Section 1: Understanding income tax

---

(LB pages 182-185)

### Overview

The content of this chapter, as part of the *Measurement* Application Topic, is drawn from page 65 in the CAPS document.

As stipulated in the CAPS document, Grade 12 learners need specifically to be able to:

- use recorded mass (weight) data, recorded length data, calculate Body Mass Index values and appropriate growth charts to monitor growth problems in children.

### Contexts and integrated content

The scope of the measured data should include the personal lives of learners, the wider community, national and global averages.

The skills that are used in this chapter are the same as those covered in Chapter 3. Skills that will be needed for success in this chapter would be:

- an understanding of the concept of percentiles
- an understanding of percentile curves
- basic graph reading and interpretation skills
- using equations.

BMI is calculated in the same way as for adults (as in Grade 11):

$$BMI = \frac{\text{Weight (in kg)}}{(\text{Height (in m)})^2}$$

However the interpretation is different when considering children. In adults, their height stays constant after a certain age (approximately 23 years of age). Therefore the only measurement that changes is weight.

In children, their height changes often. This will affect the results of the BMI calculation. In other words, a BMI that might be considered very low for an adult could be the median for a child. Therefore the BMI of a child will need to be checked against an appropriate set of BMI curves. The calculation itself is not sufficient.

## Measurement (Measuring weight: BMI, medicine dosages)

## Example

Consider two girls: **Amy** is 9 years old. She is 1,29 m tall and weighs 33 kg.

**Nontando** is 12 years old. She weighs 46 kg and is 1,52 m tall.

Their BMI's are as follows:

<u>Amy</u>	<u>Nontando</u>
$BMI = \frac{\text{Weight (kg)}}{\text{Height (m)}^2} = \frac{33 \text{ kg}}{(1,29)^2} = \frac{33 \text{ kg}}{1,6641 \text{ kg}^2}$ $= 19,83 \text{ kg/m}^2$	$BMI = \frac{\text{Weight (kg)}}{\text{Height (m)}^2} = \frac{46 \text{ kg}}{(1,52)^2} = \frac{46 \text{ kg}}{2,3104 \text{ kg}^2}$ $= 19,91 \text{ kg/m}^2$

Notice that they both have the same BMI. According to *adult* BMI assessments from Grade 11, both girls are perfectly normal. Now we reference the appropriate BMI growth curve for girls and plot each girl's age versus her BMI:

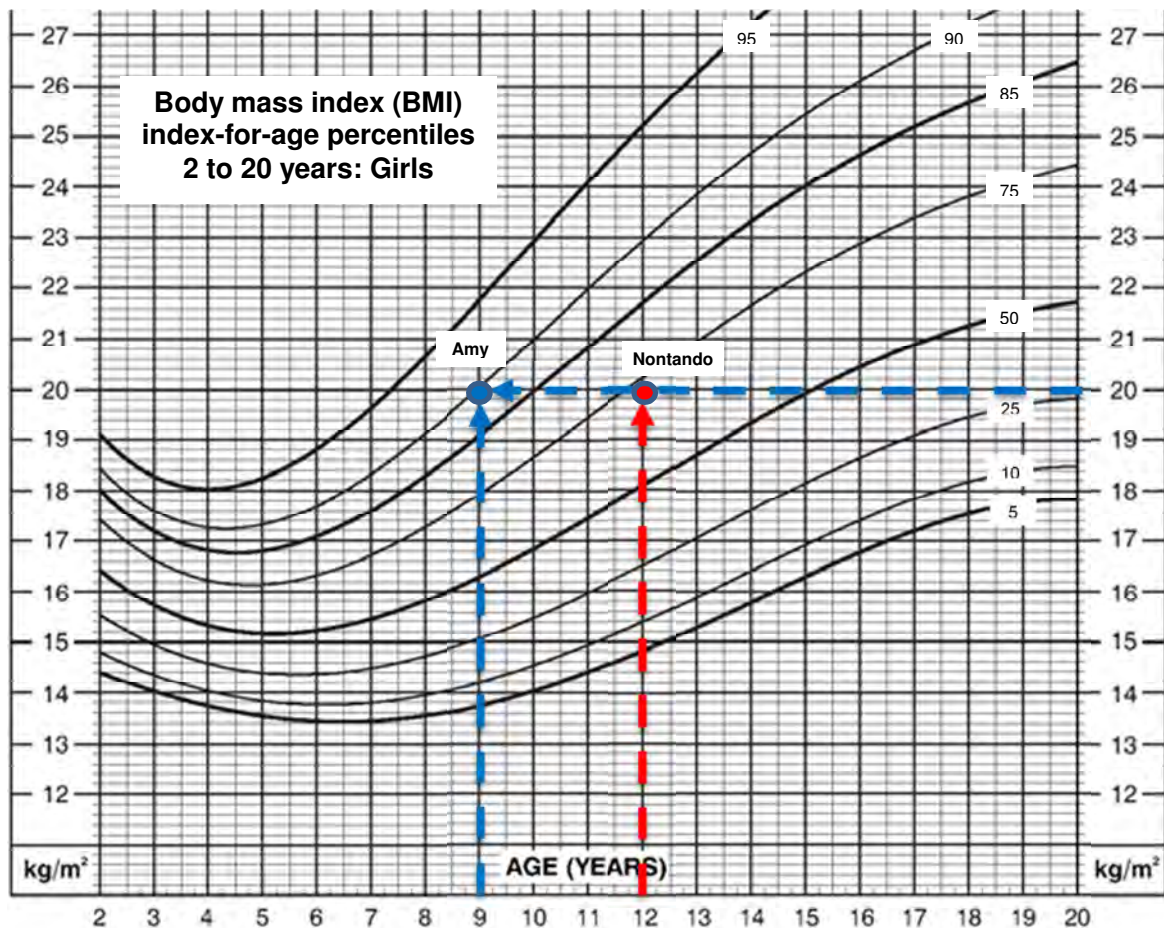

## Measurement (Measuring weight: BMI, medicine dosages)

We can see that Amy's BMI occurs on the 90<sup>th</sup> percentile curve, while Nontando is a little lower than the 75<sup>th</sup> percentile curve. To interpret the real meaning of these results, we can reference the following table:

Weight status classifications	
Weight status	Percentile range position on the growth chart
Underweight	Less than the 5th percentile
Healthy weight	$\geq$ 5th percentile and $<$ 85th percentile
At risk of overweight	$\geq$ 85th percentile and $<$ 95th percentile
Overweight	$\geq$ 95th percentile

We can now see that Amy is at risk of being overweight while Nontando actually has a fairly healthy weight.



## Section 2: Using formulae to determine medicine dosage

---

(LB pages 186-187)

### Overview

The content of this chapter, as part of the *Measurement* Application Topic, is drawn from page 65 in the CAPS document.

As stipulated in the CAPS document, Grade 12 learners need specifically to be able to:

- calculate medicine dosages using formula supplied and appropriate growth charts.

### Contexts and integrated content

The scope of the measured data should include the personal lives of learners, the wider community, national and global averages.

The skills used in this chapter relate to the application of specific formulae using known measurements. The required dosage is calculated in different ways depending on the formulae applied. An example and exercise are provided in the Learner's Book and there is no new content.

## Additional questions

1. The BMR (Basal Metabolic Rate) is the minimum amount of energy that a body needs to function. The BMR (in calories) for a woman can be calculated by using the following formula:

$$BMR = 10 \times \text{weight(in kg)} + 6,25 \times \text{height(in cm)} - 5 \times \text{age(in years)} - 161$$

- 1.1 Calculate the BMR for a 17-year old woman who weighs 46 kg and is 1,43 m tall.
- 1.2 The woman in the previous question managed to keep her weight at 46 kg and her height remained 1,43 m. Will she require more calories or fewer calories for her BMR as she grows older? Prove your answer with calculation.
- 1.3 One of the formula's for calculating a woman's ideal weight is the *J.D. Robinson formula*:

$$\text{Ideal weight} = 49 \text{ kg} + 0,7 \text{ kg} \times (\text{Height (in cm)} - 150)$$

- 1.3.1 According to the Robinson formula, what is the ideal weight for a woman who is 1,65 m tall?
- 1.3.2 What possible factors could make the Robinson formula inaccurate? List TWO factors.
2. The BMI (Body Mass Index) of a person who is over 20 years of age can be calculated by using the following formula:

$$BMI = \frac{\text{Weight (in kg)}}{(\text{Height (in m)})^2}$$

According to this value, an *adult* can be classified according to the following table:

BMI	Classification
Less than 18,5	Underweight
From 18,5 to 24,9	Normal
From 25 to 29,9	Overweight
From 30 upwards	Obese

- 2.1 Calculate the BMI of the following two people:
- Person 1: Weight: 65 kg; Height: 1,54 m
- Person 2: Weight 122 lb; Height: 70 inches tall.
- (Conversions: 2,2 lb = 1 kg ; 1 inch = 2,54 cm)

## Measurement (Measuring weight: BMI, medicine dosages)

- 2.2 How much would a person who is 1,82 m tall have to weigh to be considered obese? Show all working. (Hint: You can use *Trial and error* or any other method).
- 2.3 Use the above table to comment on the weight status of the two people in Question 2.1 if they are adults.
- 2.4 Use the BMI percentile graph for girls in the worked example and the weight status table below to answer the following questions:

Weight status classifications	
Weight status	Percentile range position on the growth chart
Underweight	Less than the 5th percentile
Healthy weight	$\geq$ 5th percentile and $<$ 85th percentile
At risk of overweight	$\geq$ 85th percentile and $<$ 95th percentile
Overweight	$\geq$ 95th percentile

- 2.4.1 If Person 1 (from Question 2.1) is a 12 year old girl, what would her weight status be?
- 2.4.2 If Person 1 is a 19 year old girl, what would her weight status be?
3. On the next page are BMI and Height/Weight percentile curves for boys. Use them to answer the following questions:
- 3.1 If Person 2 (from Question 2.1) is a boy 16 years old, what percentile would his height fall into? What does this indicate about his height? Give a reason for your answer.
- 3.2 If Person 2 is a boy 16 years old, what percentile would his weight fall into? What does this indicate about his weight? Give a reason for your answer.
- 3.3 Use the BMI graph to determine his weight status (as a 16-year old boy).
- 3.4 Use your answers to Questions 3.1 and 3.2 to explain his weight status from Question 3.3.

Measurement (Measuring weight: BMI, medicine dosages)

Body mass index (BMI) index-for-age percentiles 2 to 20 years: Boys

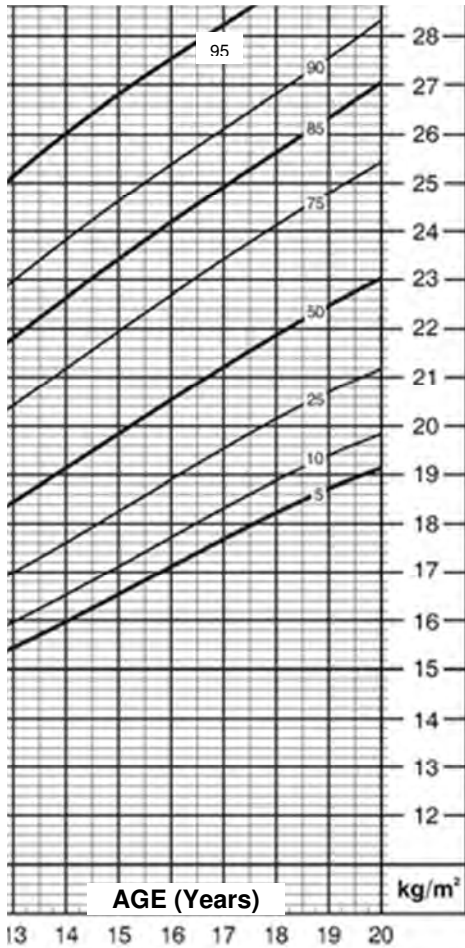

Stature (Height) for age / Weight for age percentiles 2 to 20 years: Boys

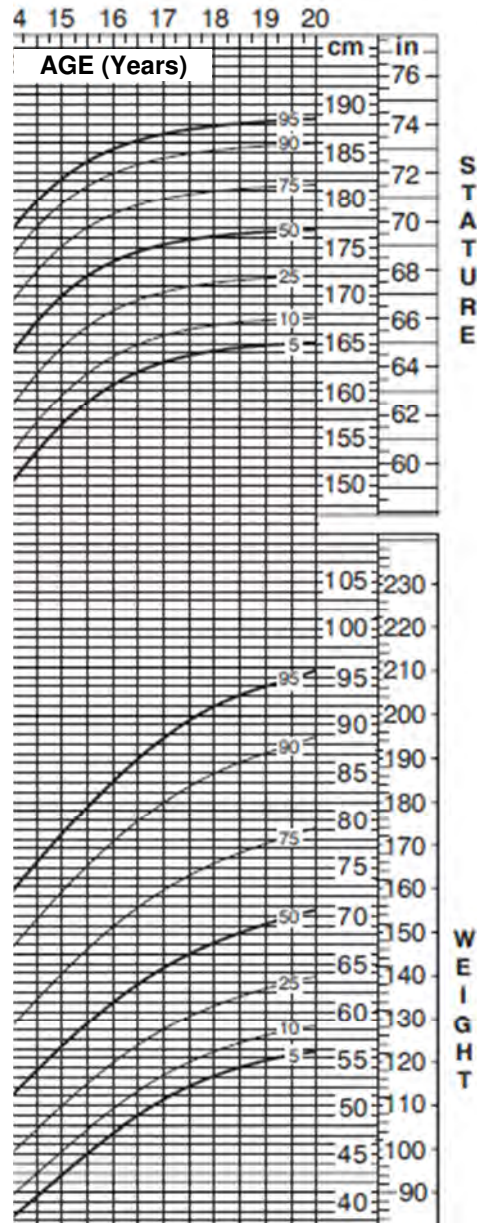

## Answers

---

(Note: This initial set of questions is not in the book, but it is worthwhile looking at a set of unfamiliar equations and seeing if we can interpret their answers)

1. 1.1  $BMR = 10 \times 46 \text{ kg} + 6,25 \times 143 \text{ cm} - 5 \times 17 - 161$   
 $= 460 + 893,75 - 85 - 161$   
 $= 1\,107,75 \text{ calories}$
- 1.2 She will require fewer calories because as her age increases the value of the '5 × age' term increases. For example, at 40 years of age:  
 $BMR = 460 + 893,75 - 5 \times 40 - 161$   
 $= 460 + 893,75 - 200 - 161$   
 $= 1\,002,75 \text{ calories}$
- 1.3 1.3.1 Ideal weight =  $49 \text{ kg} + 0,7 \text{ kg} \times (165 - 150)$   
 $= 49 \text{ kg} + 0,7 \text{ kg} \times (15)$   
 $= 49 \text{ kg} + 10,5 \text{ kg}$   
 $= 59,5 \text{ kg}$
- 1.3.2 It could be based on one race group (the ideal weight for one race group is not the same as for another). Also, it takes height into account, but it does not identify if the person is large-boned or small-boned which will affect any ideal weight calculation.
2. 2.1 Person 1:  $BMI = \text{Weight (kg)} \div (\text{Height (in m)})^2$   
 $= 65 \text{ kg} \div (1,54 \text{ m})^2$   
 $= 27,4 \text{ kg/m}^2$
- Person 2: Mass =  $122 \text{ lb} \div 2,2 \text{ lb/kg} = 55,45 \text{ kg}$   
 Height =  $70 \text{ in.} \times 2,54 \text{ in/cm} = 177,8 \text{ cm} = 1,778 \text{ m}$   
 $BMI = 55,45 \div (1,778 \text{ m})^2$   
 $= 17,5 \text{ kg/m}^2$
- 2.2 To be considered obese their BMI should be at least 30, so the equation will look like this:  
 $BMI = \text{mass} \div \text{height}^2$   
 $30 = \text{mass} \div (1,82)^2$   
 $30 = \text{mass} \div 3,3124$   
 By *Trial and error* or by equation solving methods we can find 99,4 kg.

- 2.3 Person 1: This person is considered to be overweight. This would seem to be a bit harsh as 65 kg is an average weight.  
 Person 2: This person is considered to be underweight. This makes sense because the person is very tall but yet weighs very little.
- 2.4 2.4.1 Person 1 has a BMI of  $27,4 \text{ kg/m}^2$ . By using the graph we can see that a 12-year old girl with that BMI would be above the 95<sup>th</sup> percentile which would mean that she would be drastically overweight.  
 2.4.2 By using the graph we can see that this BMI for a 19-year old is between the 85<sup>th</sup> and 95<sup>th</sup> percentile. This means that she would be at risk of being overweight (but not obese)
3. 3.1 Height = 177,8 cm.  
 Looking at the right hand graph we can see that for a 16-year old boy this height occurs on or about the 75<sup>th</sup> percentile curve. This means that he is above average height (which would be the 50<sup>th</sup> percentile curve) and that he is taller than 75% of boys his own age.
- 3.2 Weight = 55,45 kg  
 Looking at the lower part of the graph on the right we can see that for a 16-year old boy his weight is between the 10<sup>th</sup> and 25<sup>th</sup> percentile (although closer to the 10<sup>th</sup> percentile. This would indicate that he is underweight for his age.
- 3.3 BMI = 17,5 (previously calculated)  
 For a 16-year old boy, a BMI of 17,5 occurs between the 5<sup>th</sup> and the 10<sup>th</sup> percentile. The table of weight status identifies this as a healthy weight.
- 3.4 His BMI is so low relative to his age because the boy is tall and thin and so he might seem to be bordering on being unhealthy. However he might simply be going through a growth spurt.

## Section 1: Understanding taxation

---

(LB pages 216-221)

### Overview

The content of this section on Income Tax, as part of the *Finance* Application Topic, is drawn from page 59 in the CAPS document.

As stipulated in the CAPS document, Grade 12 learners need specifically to be able to:

- work with various financial documents (payslips, IRP5 forms, etc.) in order to determine an individual's taxable income, personal income tax and net pay.
- investigate the effect on an increase in salary on the amount of income tax payable.

### Contexts and integrated content

- Contexts include several types of job where a salary is earned.
- There is integration of content from the section on reading of tables and in the topic *Patterns, relationships and representations*.

### Important terminology

It is very important that you understand the terminology used in the context of income tax. These are explained in the table on the following page.

Term	Meaning
<b>Gross Salary</b>	The total amount earned in a month. This includes all types of salary (e.g. salary, overtime, bonuses, etc.)
<b>Deductions</b>	These are amounts that need to be subtracted from the gross salary <i>before</i> money is deposited into the employee's bank account. These include items such as UIF, Pension, Medical Aid, Trade Union Fees, Loan repayments, Tax, etc.
<b>Net Salary</b>	Also known as 'take home pay'. This is the amount that is deposited into an employee's bank account. It is calculated as follows:  <b>Net Salary = Gross Salary - Deductions</b>
<b>Income Tax</b>	This is a tax on all sources of income (e.g. salary, interest income, rental income, etc.). It is calculated on the taxable income.
<b>Taxable Income</b>	This is different from Net Salary although the calculation looks similar.  <b>Taxable Income = Gross Income – Tax-deductible Deductions</b>
<b>Gross Income</b>	This is different from gross salary (above) because it includes all forms of income, e.g. salary, rental income, textbook royalties, etc.
<b>Tax deductible Deductions</b>	These are specific deductions that are subtracted from the gross income before tax is calculated. There are two types of taxable deductions:  <i>Salary-based deductibles:</i> subtracted from the gross salary by the employer before the salary is paid. These include: UIF, Pension fund contributions, etc.  <i>Non-Salary deductibles:</i> These may be paid out of an employee's take-home pay, e.g. donations to charities, certain medical expenses.  There are limits placed on deductibles, e.g. the maximum amount that can be deducted for pension is 7,5% of the gross salary.
<b>Non-tax Deductible Expenses</b>	The majority of expenses are not tax deductible. These are generally living expenses, e.g. food, rent, fuel, entertainment, etc. Only tax deductible deductions reduce the amount of taxable income owed.
<b>Taxable Deductions</b>	Some deductions subtracted from an employee's payslip are taxable. Although the employee receives less money they still have to pay tax on the larger amount of money that they earned. Examples include: loans from an employer, a garnishee order, monthly payments to the employer for services rendered, etc.



## Section 2: Determining income tax

(LB pages 222-231)

### Overview

As for Section 1, the content of this section on Determining Income Tax is also drawn from page 59 in the CAPS document.

As stipulated in the CAPS document, Grade 12 learners need specifically to be able to:

- work with various financial documents (payslips, IRP5 forms, etc.) in order to determine an individual's taxable income, personal income tax and net pay.
- investigate the effect on an increase in salary on the amount of income tax payable.

### Contexts and integrated content

- Contexts include several types of job where a salary is earned.
- There is integration of content from the section on reading of tables and in the topic Patterns, relationships and representations.

Once a person's taxable income has been determined, there are two ways to calculate the total amount of tax owed: deduction tables and income tax formulae.

### Deduction tables

MONTHLY DEDUCTION TABLES

Remuneration	Annual Equivalent	Tax			Remuneration	Annual Equivalent	Tax		
		Under 65	65 - 74	Over 75			Under 65	65 - 74	Over 75
R 13,674 - R 13,694	R 164,208	R 1,534	R 1,002	R 824	R 14,724 - R 14,744	R 176,808	R 1,797	R 1,264	R 1,087
R 13,695 - R 13,715	R 164,460	R 1,540	R 1,007	R 830	R 14,745 - R 14,765	R 177,060	R 1,802	R 1,270	R 1,092
R 13,716 - R 13,736	R 164,712	R 1,545	R 1,012	R 835	R 14,766 - R 14,786	R 177,312	R 1,807	R 1,275	R 1,097
R 13,737 - R 13,757	R 164,964	R 1,550	R 1,018	R 840	R 14,787 - R 14,807	R 177,564	R 1,813	R 1,280	R 1,103
R 13,758 - R 13,778	R 165,216	R 1,555	R 1,023	R 845	R 14,808 - R 14,828	R 177,816	R 1,818	R 1,285	R 1,108

## Example

A person calculates that their taxable income is R14 803,00 per month and they are 68 years of age. How much will they need to pay in income tax per month?

**Answer:** R1 280,00 per month

## Income tax formulae

Income tax is calculated in 'tax brackets' which means that different amounts of taxable income are calculated according to the range that they fall into. Below is an example of a tax table for the 2012/2013 tax year:

6 STATUTORY RATES OF TAX (2012/2013)		
Individuals		
Tax Bracket	Taxable income (R)	Rates of tax (R)
1	0 - 160 000	18% of each R1
2	160 001 - 250 000	28 800 + 25% of the amount above 160 000
3	250 001 - 346 000	51 300 + 30% of the amount above 250 000
4	346 001 - 484 000	80 100 + 35% of the amount above 346 000
5	484 001 - 617 000	128 400 + 38% of the amount above 484 000
6	617 001 and above	178 940 + 40% of the amount above 617 000

Tax rebates individuals	
Primary rebate	R 11 440
Secondary rebate (65 years and older)	R 6 390
Tertiary rebate (75 years and older)	R 2 130
Tax thresholds individuals	
Persons under 65 years	R 63 556
Persons 65 years and older	R 99 056
Persons 75 years and older	R 110 889

## Important terminology for tax tables

Term	Meaning
<b>Tax Bracket</b>	<ul style="list-style-type: none"> <li>A range of taxable incomes that are charged according to a set rate of tax.</li> <li>The values are the <i>annual</i> taxable amounts.</li> <li>The higher the bracket, the higher the tax rate for that portion of the taxable income.</li> </ul>
<b>Tax Rebate</b>	<ul style="list-style-type: none"> <li>An amount that is deducted from the tax that has to be paid.</li> <li>It is a <i>maximum</i> amount. Therefore if someone owes less tax than the total tax rebate they will pay no tax but will NOT receive the amount left over in cash.</li> <li>Only people who pay tax are eligible for the rebate.</li> <li>There are three rebates. Everyone is eligible for the primary rebate. Tax payers who are 65 years and older qualify for the additional secondary rebate. Tax payers who are 75 years and older qualify for all three rebates.</li> </ul>
<b>Tax Threshold</b>	<ul style="list-style-type: none"> <li>This is the minimum salary a person must earn before tax is charged.</li> <li>Below the threshold, the person's tax will be cancelled by the tax rebate.</li> </ul>

### How do the tax brackets work?

Here is how the tax brackets calculate the tax on R400 000:

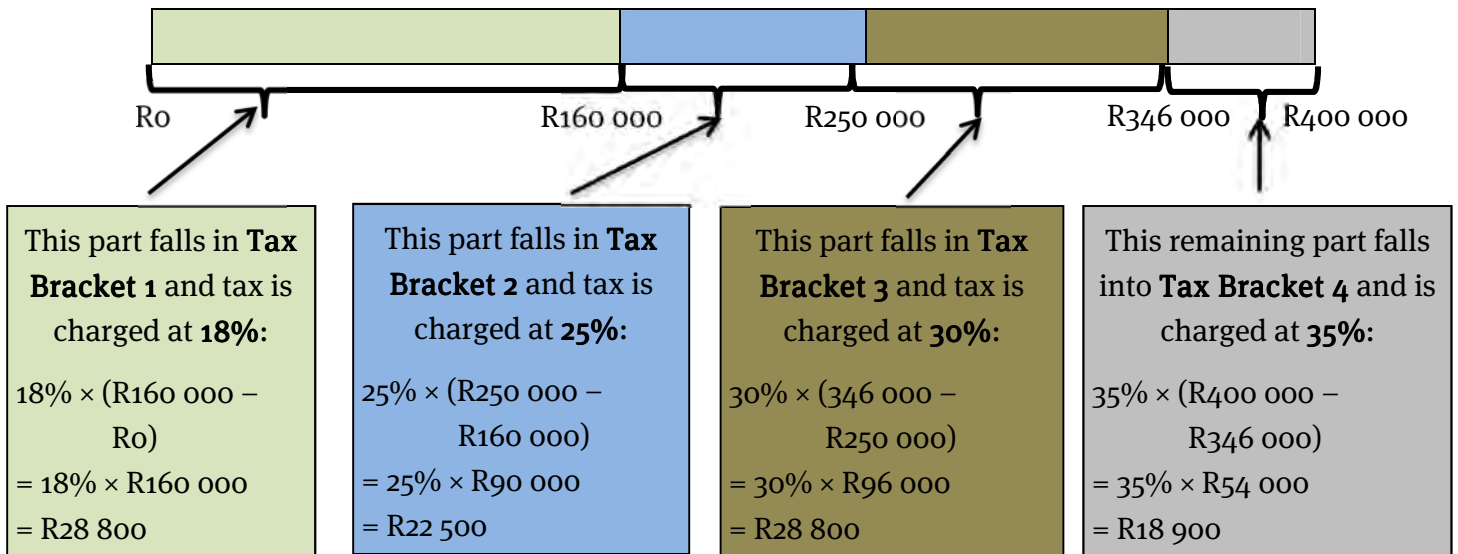

Notice that R400 000 occurs in Tax Bracket 4 and the formula for that bracket is:

Annual Tax = R80 100 + 35% of the amount above R346 000

$$= (R28\,800 + R22\,500 + R28\,800) + 35\% \times (R400\,000 - R346\,000)$$

So the **fixed amount** in the formula is the **total of all the previous tax brackets**.

### Example

Using the tax tables, calculate how much tax a 68-year old person should pay if their monthly taxable income is R14 803,00.

**Answer:**

The *annual* taxable income = R14 803,00 × 12 = R177 636,00

Referring to the tax table that follows, this amount occurs in Tax Bracket 2.

6 STATUTORY RATES OF TAX		(2012/2013)
<b>Individuals</b>		
Tax Bracket	Taxable income (R)	Rates of tax (R)
1	0 - 160 000	18% of each R1
2	160 001 - 250 000	28 800 + 25% of the amount above 160 000
3	250 001 - 346 000	51 300 + 30% of the amount above 250 000
4	346 001 - 484 000	80 100 + 35% of the amount above 346 000
5	484 001 - 617 000	128 400 + 38% of the amount above 484 000
6	617 001 and above	178 940 + 40% of the amount above 617 000

The formula for Tax Bracket 2:

$$\text{Annual tax} = R28\,800 + 25\% \text{ of the amount above } R160\,000$$

$$= R28\,800 + 25 \div 100 \times (R177\,636 - R160\,000)$$

$$= R28\,800 + 25 \div 100 \times (R17\,636)$$

$$= R28\,800 + R4\,409,00$$

$$= R33\,209,00$$

Tax rebates individuals	
Primary rebate	R 11 440
Secondary rebate (65 years and older)	R 6 390
Tertiary rebate (75 years and older)	R 2 130
<b>Tax thresholds individuals</b>	
Persons under 65 years	R 63 556
Persons 65 years and older	R 99 056
Persons 75 years and older	R 110 889

Apply the rebate:

The tax payer is over 65 years of age but less than 75 years of age, so they qualify for the primary and secondary rebates:

$$\text{Total Tax owed} = R33\,209,00 - R11\,440 - R6\,390$$

$$= R15\,379,00 \text{ per year}$$

$$\text{Monthly Tax owed} = R15\,379,00 \div 12 = \mathbf{R1\,281,58}$$

**Note:** See that this amount is very similar to the amount from the deduction tables. The value in the deduction tables is rounded down to the nearest R5,00.

## Section 3: IRP5 tax forms

---

(LB pages 234-235)

### Overview

Again, this section on IRP5 tax forms is drawn from page 59 in the CAPS document.

As stipulated in the CAPS document, Grade 12 learners need specifically to be able to:

- work with various financial documents (payslips, IRP5 forms, etc.) in order to determine an individual's taxable income, personal income tax and net pay.
- investigate the effect on an increase in salary on the amount of income tax payable.

### Contexts and integrated content

- Contexts include several types of job where a salary is earned.
- There is integration of content from the section on reading of tables and in the topic *Patterns, relationships and representations*.

### IRP5 forms

These contain a summary of:

- the total amount that an employee has earned
- any deductions that were made (e.g. pension, UIF, etc.)
- any tax deducted from the employee's salary

The information on the IRP5 will be used by the employee to fill out a tax return at the end of the tax year.

An employee has to obtain an IRP5 certificate from each employer that they have worked for in any given tax year and total all of the information across all of them.

## Additional questions

The following Income tax tables are for the 2012/2013 tax year. Use them to answer the questions below:

6 STATUTORY RATES OF TAX		(2012/2013)
<b>Individuals</b>		
Tax Bracket	Taxable income (R)	Rates of tax (R)
1	0 - 160 000	18% of each R1
2	160 001 - 250 000	28 800 + 25% of the amount above 160 000
3	250 001 - 346 000	51 300 + 30% of the amount above 250 000
4	346 001 - 484 000	80 100 + 35% of the amount above 346 000
5	484 001 - 617 000	128 400 + 38% of the amount above 484 000
6	617 001 and above	178 940 + 40% of the amount above 617 000
<b>Tax rebates individuals</b>		
Primary rebate		R 11 440
Secondary rebate (65 years and older)		R 6 390
Tertiary rebate (75 years and older)		R 2 130
<b>Tax thresholds individuals</b>		
Persons under 65 years		R 63 556
Persons 65 years and older		R 99 056
Persons 75 years and older		R 110 889

- Calculate the total annual tax owed (after the rebate has been considered) for the following people:
  - Sindiswa is 23 years old and has a taxable income of R120 560,00 per year.
  - John is 36 years old and has a taxable income of R283 756,00 per year.
  - Xolisa is 26 years old and has a taxable income of R18 435,00 per month.
  - Banele is 68 years old and has a taxable income of R18 435,00 per month.
- Using your answers to Question 1, calculate the net monthly incomes for the four people listed in Question 1.
- Mr Modise is 39 years of age and earns a salary of R34 857 per month.

The following deductions are taken off his monthly salary:

Pension: R3 250,00

UIF (1% of his gross salary)

Medical Aid: R5 423,00

Repayment of a loan from his employer: R2 500,00 per month

- 3.1 His UIF contribution is calculated at 1% of his gross income. Calculate his UIF amount.
- 3.2 With regard to pensions, a maximum of 7,5% of his gross income may be tax deductible. Calculate his total deductible pension amount.
- 3.3 The only tax deductible items are his deductible pension amount (Question 3.2) and his UIF amount (Question 3.1). Calculate his taxable income (Gross income – tax deductions).
- 3.4 Use your answer from Question 3.3 and the 2012/2013 Income tax tables to calculate his *monthly* tax owed.
- 3.5 In addition to the standard rebate, the South African Revenue Service (SARS) also gives each tax payer a medical tax credit. The total monthly medical tax credit is the total of the following amounts:  
*R230 for the tax payer + R230 for the spouse + R154 per child.*  
Calculate Mr Modise's total medical tax credit if he has a wife and four children.
- 3.6 Using your previous answers calculate his 'Take-home' pay as follows:  
*'Take-home' Pay = Gross Income – Deductions – Income Tax + Medical Tax Credit*

## Answers

---

1. 1.1 Her taxable income falls into the first tax bracket, therefore she will pay tax as follows:

$$\begin{aligned}\text{Total tax owed (before rebate)} &= 18\% \text{ of R120 560,00} \\ &= \text{R21 700,80}\end{aligned}$$

$$\text{After rebate} = \text{R21 700,80} - \text{R11 440} = \text{R10 259,20}$$

- 1.2 His taxable income falls into the third tax bracket, therefore he will pay tax as follows:

$$\begin{aligned}\text{Total tax owed (before rebate)} &= \text{R51 300} + 30\% \text{ of } (\text{R283 756} - \text{R250 000}) \\ &= \text{R51 300} + 0,3 \times \text{R33 756} \\ &= \text{R51 300} + \text{R10 126,80} \\ &= \text{R61 426,80}\end{aligned}$$

$$\text{After rebate} = \text{R61 426,80} - \text{R11 440} = \text{R49 986,80}$$

- 1.3 Annual taxable income =  $\text{R18 435,00} \times 12 = \text{R221 220}$

Therefore her taxable income falls into the second tax bracket, so she will pay tax as follows:

$$\begin{aligned}\text{Total tax owed (before rebate)} &= \text{R28 800} + 25\% \text{ of } (\text{R221 220} - \text{R160 000}) \\ &= \text{R28 800} + 0,25 \times \text{R61 220} \\ &= \text{R28 800} + \text{R15 305,00} \\ &= \text{R44 105,00}\end{aligned}$$

$$\text{After rebate} = \text{R44 105,00} - \text{R11 440} = \text{R32 665,00}$$

- 1.4 Annual taxable income =  $\text{R18 435,00} \times 12 = \text{R221 220}$

His tax owed before the rebate will be the same as Xolisa's: R44 105,00

However, due to his age, he is granted the first additional rebate:

$$\text{After rebate} = \text{R44 105,00} - \text{R11 440} - \text{R6 390} = \text{R26 275,00}$$

2. 2.1 Net annual income = Gross Taxable Income – Annual Tax
- $$\begin{aligned}&= \text{R120 560,00} - \text{R10 259,20} \\ &= \text{R110 300,80 p.a.}\end{aligned}$$

So net monthly income = R9 191,73 per month

- 2.2 Net annual income =  $\text{R283 756} - \text{R49 986,80}$
- $$= \text{R233 769,20 p.a.}$$

So net monthly income = R19 480,77 per month

- 2.3 Net annual income =  $\text{R221 220} - \text{R32 665,00}$



$$= R188\,555,00 \text{ p.a.}$$

$$\text{So net monthly income} = R15\,712,92$$

$$2.4 \text{ Net annual income} = R221\,220 - R26\,275,00$$

$$= R194\,945,00 \text{ p.a.}$$

$$\text{So net monthly income} = R16\,245,42 \text{ per month}$$

(so he gets approximately R500 per month more with the extra rebate).

$$3. \quad 3.1 \quad 1\% \text{ of } R34\,857,00 = R348,57$$

$$3.2 \quad 7,5\% \text{ of } R34\,857,00 = R2\,614,28$$

$$3.3 \quad \text{Taxable income} = \text{Gross income} - \text{tax deductions}$$

$$= R34\,857,00 - R348,57 - R2\,614,28$$

$$= R31\,894,15 \text{ per month}$$

$$3.4 \quad \text{Annual taxable income} = R31\,894,15 \times 12 = R382\,729,80$$

This income occurs in tax bracket 4, therefore:

$$\text{Total tax owed (before rebate)} = R80\,100 + 35\% \text{ of } (382\,729,80 - R346\,000)$$

$$= R80\,100 + 0,35 \times R36\,729,80$$

$$= R80\,100 + R12\,855,43$$

$$= R92\,955,43$$

$$\text{After rebate} = R92\,955,43 - R11\,440 = R81\,515,43 \text{ per year}$$

$$= R6\,792,95 \text{ per month}$$

$$3.5 \quad \text{Total medical tax credit} = R230 \times 2 + R154 \times 4$$

$$= R1\,076,00$$

$$3.6 \quad \text{'Take-home' pay} = \text{Gross Inc.} - \text{Deductions} - \text{Income Tax} + \text{Medical Tax Credit}$$

$$\text{Deductions} = \text{Pension} + \text{UIF} + \text{Medical Aid} + \text{Loan repayment}$$

$$= R3\,250,00 + R348,57 + R5\,423,00 + R2\,500,00$$

$$= R11\,521,57$$

Note: These are all of the deductions from his salary in full. We only consider the tax deductibility of an item when working out the income tax. Once the tax has been deducted, we perform the 'take-home' calculation with the full deduction amount.

$$\text{'Take-home' pay} = R34\,857,00 - R11\,521,57 - R6\,792,95 + R1\,076,00$$

$$= R17\,618,48$$

## Section 1: Ways of working with exchange rates and currency conversions

(LB pages 240-243)

### Overview

The content of this section on Exchange Rates, as part of the *Finance* Application Topic, is drawn from page 60 in the CAPS document.

As stipulated in the CAPS document, Grade 12 learners need to be able to do the following:

- Work with exchange rates presented in foreign exchange tables.

### Contexts and integrated content

This chapter draws on the same skills covered in Grade 11, but extends the scope to include charges levied by financial exchange institutions.

### Example

A BigMac burger costs R19,95 in South Africa and £2,69 in Britain.

The current exchange rate for UK pounds (GBP) and Rands (ZAR) is:

$$1 \text{ GBP} = 14,2376 \text{ ZAR}$$

Which burger is cheaper when taking the exchange rate into account?

### Estimate first

Whether a person is calculating a price in another currency accurately or not, it is a good idea to estimate first.

The exchange rate can be rounded off to  $1 \text{ GBP} \approx 14 \text{ ZAR}$

So  $2,69 \text{ GBP} \times 14 \approx \text{R}38,00$  (Phew, almost double the price!)

### A useful method

In order to calculate accurately it is useful to have an easy method. The **Fraction method** states:

***Divide by the unit you have, times by the unit you need***

**Finance (exchange rates)**

Convert the price of the BigMac from Rands to pounds (GBP) for a visiting British tourist:

$$R19,95 \div 14,2376 \text{ ZAR} = 1,401219 \times 1 \text{ GBP} = \mathbf{1,40 \text{ GBP}}$$

We divide by the Rands side of the exchange rate because our price started in Rands and then multiply by the pounds side of the exchange rate.

## Section 2: Buying and selling currency

(LB pages 244-249)

### Overview

As for Section 1, the content of this section on Exchange Rates, as part of the *Finance* Application Topic, is also drawn from page 60 in the CAPS document.

As stipulated in the CAPS document, Grade 12 learners need to be able to:

- work with exchange rates presented in foreign exchange tables.

### Contexts and integrated content

This chapter draws on the same skills covered in Grade 11, but extends the scope to include charges levied by financial exchange institutions.

When thinking about buying and selling currency it is useful to think of those terms from the bank's perspective:

**Buying currency:** The bank is buying the currency from a person (so the person is getting rid of their foreign currency).

**Selling currency:** The bank is selling the currency to a person (so the person is trying to gain foreign currency).

### Example

The following currency exchange rates refer to the South African Rand and the Botswana Pula. Note that each Pula exchange rate is related to 1 Rand due to it being a South African bank. Use the appropriate rate to calculate the following:

Country	Bank Buying			Bank Selling	
	T/T	Cheques	Notes	Cheques & T/T	Notes
<b>EXCHANGE RATE ON BASIS OF FOREIGN CURRENCY PER R1</b>					
(BWP)	0.9612	0.9674	0.9872	0.9218	0.9218

1. Exchange R3 000,00 into Pula (BWP) at the above South African bank.

**Answer:** The Rand is being used to buy Pula, so we use the buying rate:

$$R3\ 000,00 \div R1,00 \times \text{BWP } 0,9218 = R2\ 765,40$$

## Finance (exchange rates)

2. Exchange 2 000 Pula into Rands at the above South African bank.

**Answer:** The Pula is being bought by the bank because it is foreign currency:

$$2\,000 \text{ BWP} \div 0,9872 \text{ BWP} \times \text{R}1,00 = \text{R}2\,025,93$$

### Fees on foreign exchange transactions

Banks also charge a fee for the service of buying or selling currency. Each bank (or Bureau de Change) has its own rules governing these fees. The following diagram illustrates the process which is followed when calculating the amount of money to buy or sell:

#### Buying a fixed amount of foreign currency

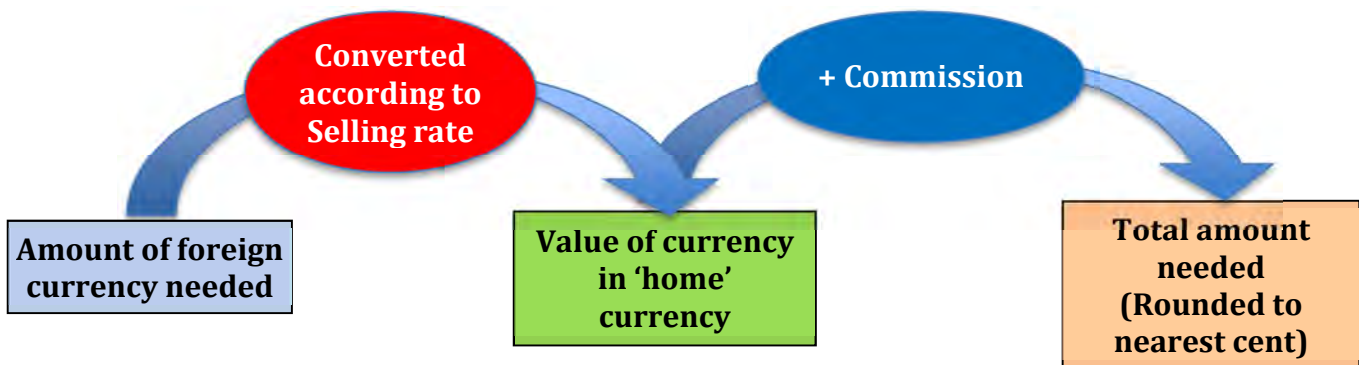

#### Buying foreign currency with a fixed amount of money

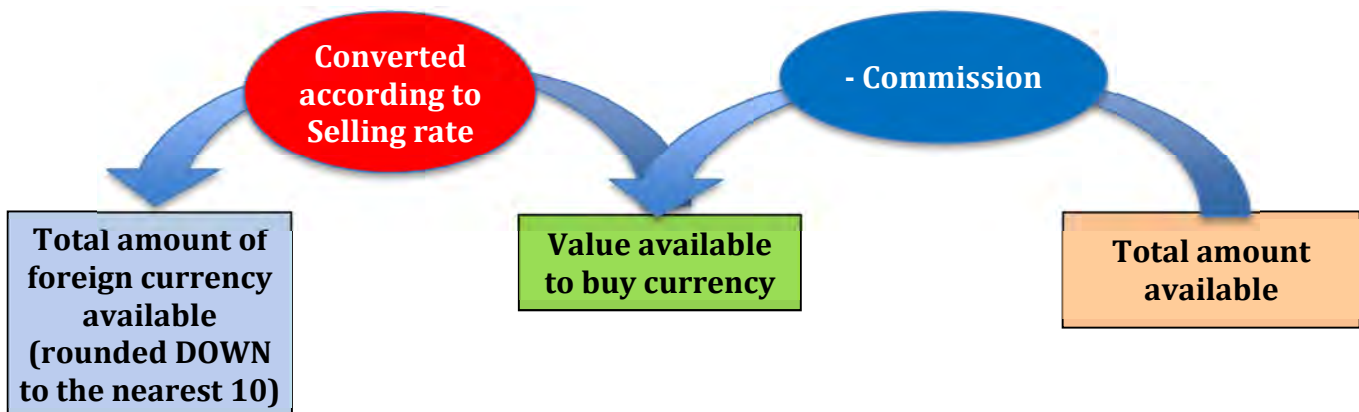

### Selling currency to an exchange agent

Selling currency to an exchange agent (bank or Bureau de Change)

Finance (exchange rates)

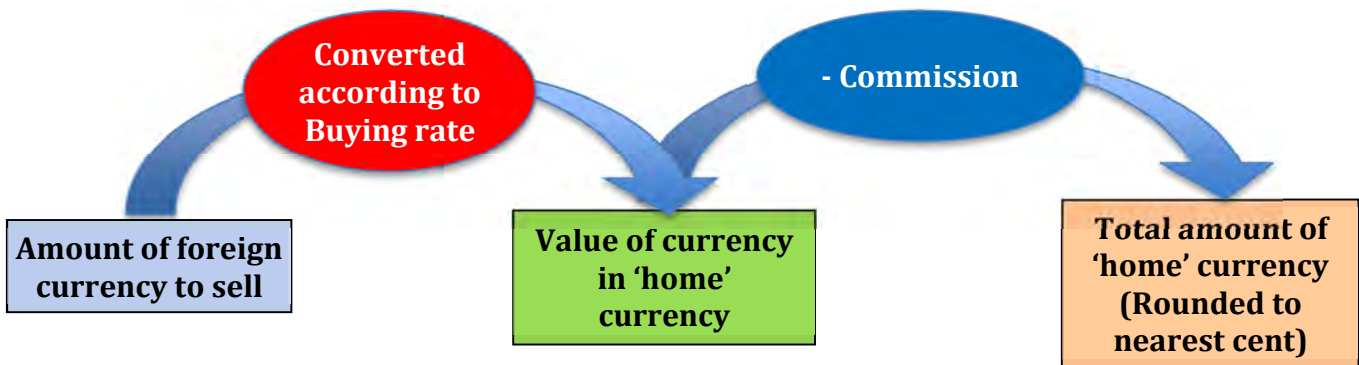

Selling currency to obtain a specific amount of 'home currency' from an exchange agent (bank or Bureau de Change)

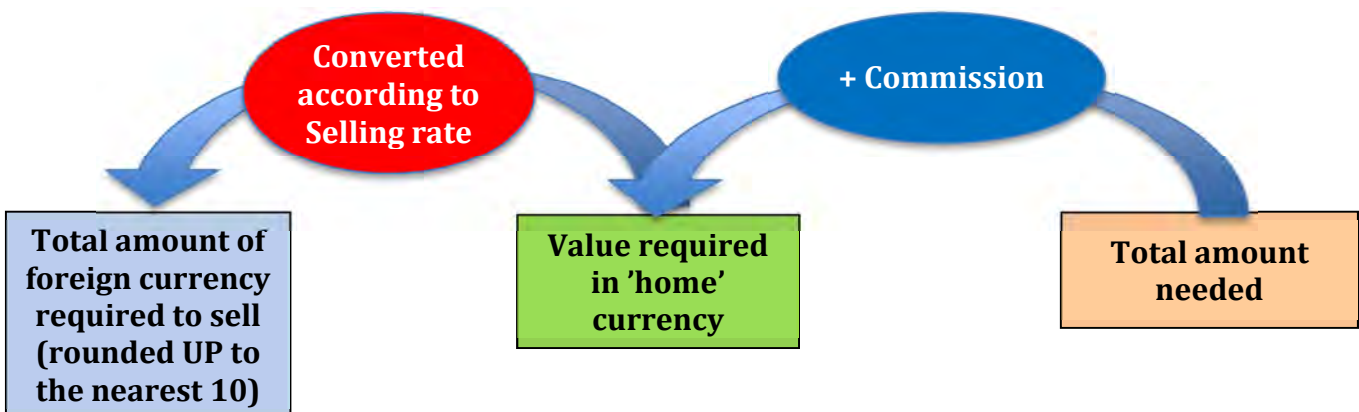

Example

The following currency exchange fees and exchange rates apply to foreign exchange transactions:

Transaction Type	Buying Foreign Currency from Standard Bank			Selling Foreign Currency to Standard Bank		
	Fee	Minimum	Maximum	Fee	Minimum	Maximum
Foreign Notes	1,85%	R70,00	None	1,85%	R60,00	None

Country	Bank Buying			Bank Selling	
	T/T	Cheques	Notes	Cheques & T/T	Notes
EXCHANGE RATE ON BASIS OF RAND PER UNIT FOREIGN CURRENCY					
(£)	12.4550	12.426	12.3325	12.9655	13.0615
(€)	9.8882	9.8608	9.7637	10.3298	10.3598
(\$)	7.9657	7.9299	7.9582	8.2832	8.2832

Note that the exchange rates are Rand values of a unit of the given currency (e.g. Buying rate for UK Pounds (£) notes: £1,00 = R12,3325)

- Buy £200,00 using South African Rand from the above bank.

**Answer:** Convert to the 'home' currency:  
 $\text{R}200,00 \div \text{£}1 \times \text{R}13,0615 = \text{R}2\ 612,30$

## Finance (exchange rates)

Calculate commission:

$$R2\ 612,30 \times 1,85\% = R48,33$$

This is smaller than the minimum charge for 'buying from Standard Bank', so the minimum charge of R70,00 applies.

$$\begin{aligned} \text{Total owed} &= R2\ 612,30 + R70,00 \\ &= \mathbf{R2\ 682,30} \end{aligned}$$

2. How many US Dollars (\$) can be bought with R5 000,00?

**Answer:** Calculate commission:

$$R5\ 000,00 \times 1,85\% = R92,50$$

Amount available to purchase US Dollars (after commission):

$$R5000,00 - R92,50 = R4\ 907,50$$

Maximum amount of US Dollars that can be purchased:

$$R4\ 907,50 \div R7,9582 \times R1 = \$616,66$$

However, notes are only sold rounded down to the nearest 10.

Maximum amount of US Dollars that can be bought = **\$610**.

The selling rate for US Dollar notes is used because the bank is *selling* notes to the client.

**Checking solution:**

$$\$610 \times R7,9582/\$ = R4\ 854,50$$

This amount is a little less than the amount of Rand available to purchase US Dollars so it seems to be correct.

## Additional questions

1. Referring to the table of exchange rates, answer the following questions:

ABSA Bank					
FOREX CLOSING INDICATION RATES FOR 02 February 2013 as at 16:00					
Country	Bank Buying			Bank Selling	
	T/T	Cheques	Notes	Cheques & T/T	Notes
<b>EXCHANGE RATE ON BASIS OF RAND PER UNIT FOREIGN CURRENCY</b>					
BRITISH POUND (£)	13.7395	13.6295	13.5295	14.3385	14.4375
EURO (€)	11.8262	11.8062	11.3972	12.3523	12.4013
US DOLLARS (\$)	8.5749	8.5539	8.5219	9.2154	9.2454
<b>EXCHANGE RATE ON BASIS OF FOREIGN CURRENCY PER R1</b>					
BOTSWANA PULA (BWP)	0.9271	0.9481	0.9712	0.898	0.877
KENYAN SHILLING (KES)	10.2285	10.2285	0	9.3785	9.3785
MOZAMBIQUE METICAL (MZN)	0.0	0.0	0.0	3.4013	0.0
NAMIBIAN DOLLAR (NAD)	1.0	1.0	1.0	1.0	1.0
NIGERIAN NAIRA (NGN)	0.0	0.0	0.0	17.39	0.0
SWAZILAND LILANGE (SZL)	1.0	1.0	1.0	1.0	1.0

- 1.1 Why does the Nigerian Naira have an exchange rate of 0,0 for both buying and selling notes?
- 1.2 Both the Namibian Dollar and the Swaziland Lilange have an exchange rate of 1,0 to the South African Rand. What does this mean?
- 1.3 Calculate:
  - 1.3.1 How many Rands will be needed to buy \$4 000 in notes from the bank?
  - 1.3.2 How many Rands will be given in exchange when selling \$4 000 in notes?
  - 1.3.3 How many Euros (in notes) could be bought with R4 000?
  - 1.3.4 How many BWP (in notes) could be bought with R4 000?
  - 1.3.5 How many BWP were sold if R2 677,10 were obtained in exchange?
  - 1.3.6 How many British Pounds could be bought with \$2 000 using the exchange rates in the table?
2. ABSA bank charges the following fees for foreign exchange transactions. Use these fees to answer the following questions:
  - 2.1 R43 404,55 is required to purchase €3 500 in notes from ABSA bank according to the exchange rates.



## Finance (exchange rates)

Foreign exchange fees as at February 2013						
	Buying Foreign Currency from ABSA Bank			Selling Foreign Currency to ABSA Bank		
Transaction Type	Fee	Minimum	Maximum	Fee	Minimum	Maximum
Foreign notes	1,68%	R115,00	None	1,68%	R115,00	None
Traveller's Cheques	1.71%	R130,00	None	1.71%	R130,00	None

- 2.1.1 Calculate the fee that will be paid on the transaction.
- 2.1.2 Calculate the total amount in Rands that will be required to purchase €3 500.
- 2.1.3 Without any further calculation, state whether it will be cheaper to purchase the Euro notes from Standard bank (use the earlier table of fees in the example). Give a reason for your answer.
- 2.2 £2 450 in Travellers' Cheques is sold back to the bank.
- 2.2.1 How many Rands will the bank pay for the cheques?
- 2.2.2 After the bank fees are taken into account, how much will the person exchanging the money receive (in Rands)?
- 2.3 A person has R3 500 available to purchase US Dollars for a holiday. Taking the bank fees into account, how much US Dollar currency could be bought (in notes)?
3. A traveller to the US is considering two options to get foreign currency:
- Option 1:* Buy all the notes he needs at ABSA bank before his trip starts.
- Option 2:* Use his bank ATM card to withdraw cash as he needs it from the ATM's in the US.
- 3.1 He estimates that he will need \$3 000 in notes during his trip. Use the exchange rates and fee tables above to calculate how much this will cost him in Rands.
- 3.2 ABSA bank charges a fee of R45 per withdrawal from a US ATM when you use your South African bank card. He will withdraw six times during his trip (\$500 each time). Which method is cheaper?
4. A woman went on a tour to Britain in April 2012. She bought £2 000 in notes from Standard Bank before her trip.
- 4.1 Use the currency table and fees from the example (where currency was purchased from Standard Bank) to calculate the total *fees* that would be paid to purchase the notes.

**Finance (exchange rates)**

- 4.2 When she returned from her trip, she still had £360 in notes left over. However she forgot to exchange it. She found the notes in a bag when she was doing a clean out 10 months later! She decided to exchange them at ABSA bank. Calculate the *fees* that she would have paid to sell the notes to ABSA bank (using the above table and fee structure).
- 4.3 Calculate the total fees she paid for both transactions.
- 4.4 Do you think that she should have rather used her ATM card to draw the cash in the UK (at a fee of R45 per withdrawal)? Prove your answer with calculations.

## Answers

---

1. 1.1 ABSA bank does not sell Nigerian Naira notes or traveller's cheques (it would surely use a different way of selling currency to a customer)
- 1.2 This means that they will both exchange money on a 1 : 1 basis with South African Rand (i.e. 1 NAD = 1 Rand)
- 1.3 1.3.1  $\$1 = R9,2454$ , therefore  $\$4\ 000 \times R9,2454 = R36\ 981,60$  (the bank is *selling* the notes to the customer)
- 1.3.2  $\$1 = R8,5219$ , therefore  $\$4\ 000 \times R8,5219 = R34\ 087,60$  (the bank is *buying* the notes from the customer)
- 1.3.3  $R12,4013 = \text{€}1$ , therefore  $R4\ 000 \div R12,4013 = \text{€}355,55$
- 1.3.4  $\text{BWP } 0,877 = R1$ , therefore  $R4000 \div R1 \times \text{BWP } 0,877 = \text{BWP } 3508$
- 1.3.5  $\text{BWP } 0,9712 = R1$  (Bank buying rate), therefore  $R2\ 677,10 \times \text{BWP } 0,9712 = \text{BWP } 2\ 600$
- 1.3.6  $\$1 = R9,2454$  (bank selling rate), so  $\$2\ 000 \times R9,2454 = R18\ 490,80$   
 $\text{€}1 = R14,4375$  (bank selling rate), so  $R18\ 490,80 \div R14,4375 = \text{€}1\ 280,75$   
 Therefore  $\$2\ 000$  will purchase  $\text{€}1\ 280,75$ .
2. 2.1 2.1.1 Fee = 1,68% of amount (in Rands)  
 $= 0,0168 \times R43\ 404,55 = R729,20$  (and this exceeds the minimum amount so it will be the fee paid).
- 2.1.2 Total = Exchange amount + Fees  
 $= R43\ 404,55 + R729,20$   
 $= R44\ 133,75$
- 2.1.3 It will not be cheaper as the rate used to calculate the fee is higher (it is 1,85% instead of ABSA bank's 1,68%).
- 2.2 2.2.1  $\text{€}1 = R13,6295$  (bank buying rate for traveller's cheques)  
 $\text{€}2\ 450 \div \text{€}1 \times R13,6295 = R33\ 392,28$
- 2.2.2 Fees = 1,71% of Rand amount =  $0,0171 \times R33\ 392,28$   
 $= R571,01$
- Total received from bank = Exchange amount – fees  
 $= R33\ 392,28 - R571,01 = R32\ 821,27$
- 2.3 Take money away for the fees:  $1,68\% \times R3\ 500 = R58,80$  (this is not the totally correct amount, but it will give us an approximate figure to work with).

## Finance (exchange rates)

Therefore, money available to exchange = R3 500 – R58,80 = R3 441,20

The bank is selling the notes, so the rate will be: R9,2454 = \$1, therefore the amount of currency that can be bought = R3 441,20 ÷ R9,2454 = \$372,21

This will be rounded down to the nearest dollar amount as banks do not deal in cents, only in notes: \$372 in notes.

3. 3.1 Bank selling rate: R9,2454 = \$1  
Amount in Rands = \$3 000 × R9,2454 = R27 736,20  
Fees = 1,68% of R27 736,20 = R465,97
- 3.2 Total fees from ATM's = 6 × R45 = R270. This method is much cheaper, and safer as he will not be carrying around all his cash with him.
4. 4.1 Standard Bank: £1 = R10,3598 (Selling rate)  
Rands equivalent = £2 000 × R10,3598 = R20 719,60  
Fees = 1,85% of R20 719,60 = R383,31
- 4.2 ABSA bank (10 months later): £1 = R13,7395  
Amount of rands = £360 × R13,7395 = R4946,22  
Fees = 1,68% of R4 946,22 = R83,10
- 4.3 Total fees = Buying fees + selling fees = R383,31 + R83,10 = R466,41
- 4.4 This would seem to have been the wiser course of action. At R45 per withdrawal, she could have made 10 withdrawals for the same fees and have had fewer pounds left over when she returned.

## Maps and plans (plans and scale)

### Section 1: Interpreting plans

---

(LB pages 254-255)

This is revision of Grade 11 work and as such will not be reviewed here. The aim of this section in the textbook was to assist the learner to interact with the plan and identify features in it.

### Section 2: Determining scales

---

(LB pages 256-259)

#### Overview

The content of this section on plans and scale as part of the *Maps, plans and other representations of the physical world* Application Topic and is drawn from pages 73 and 76-78 in the CAPS document.

As stipulated in the CAPS document, Grade 12 learners need to be able to do the following:

- Determine the scale in which a plan has been drawn in the form 1 :... and use the scale to determine other dimensions on the plan.
- Draw scaled 2-D floor and elevation plans for a complex structure (e.g. RDP house)

#### Contexts and integrated content

This chapter draws on the use of scale which was covered earlier in Chapter 5. Scale itself draws on the skill of using ratio which is from the *Numbers and calculations with numbers* Topic.

## Maps and plans (plans and scale)

### Determining the scale in which a plan has been drawn.

This utilises the skills that were covered in Section 3 of Chapter 5 of this study guide (on page 67) in a different context:

#### Example

This is the same scale drawing as the one found in the Learner's Book on page 256. The drawing is to the same scale as the one in the Learner's Book. To confirm this we will measure the height of the roof.

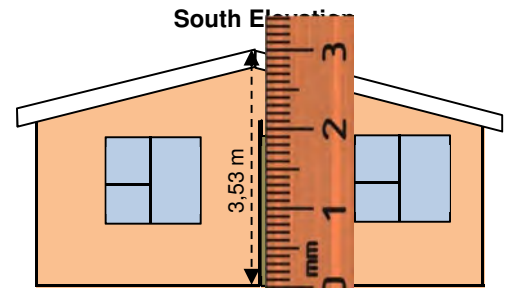

- 1 The measurement is 2,9 cm for a real life measurement of 3,53 m. Therefore the scale is:  
 $2,9 \text{ cm} : 3,53 \text{ m}$
- 2  $3,53 \text{ m} = 353 \text{ cm}$ , therefore if we write the measurements in the same units, we see that the scale is:  $2,9 \text{ cm} : 353 \text{ cm}$
- 3 Divide both sides by the **Map** measurement (to get the Map side of the scale to be 1):  $2,9 \text{ cm} \div 2,9 \text{ cm} = 1$  and  $353 \text{ cm} \div 2,9 \text{ cm} = 121,7$ , therefore the scale is:  
 $1 : 121,7 \approx 1 : 120$

**Note:** Due to the small scale of the drawing, there is not much difference to the value that was calculated in the Learner's Book unlike the calculation in Chapter 5 of the study guide.

The small difference that was present was due to the limits to how accurately we can measure with a ruler.

### Using the number scale to create a bar scale

A number scale is useful because it shows exactly how much smaller the picture on the plan is than the actual size of the object. However, this number scale becomes inaccurate as soon as the size of the plan is changed. As such, it is often useful to be able to create a bar scale for a plan.

## Maps and plans (plans and scale)

### Example

Create a bar scale for a 1:50 plan.

- A scale of 1:50 means that 1 cm on the map is the same as 50 cm in real life.
- Converting this to metres, we can see that 1 cm on the map represents 0,5 m in real life. However 0,5 m is not as easy to read as 1 m would be, so we rather double both measurements: 2 cm : 1 m
- Now that we have easier numbers, we create a rectangle that is 2 cm long with divisions after every cm:
- This bar scale seems a bit small, so we can scale it up to 6 cm to make it easier to use:

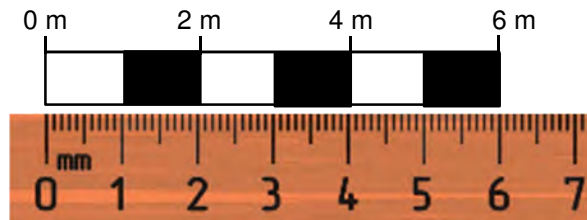
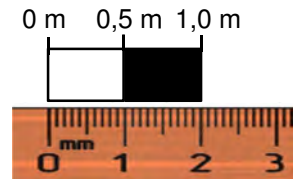

### Drawing a missing elevation plan

- When drawing a missing elevation plan we can often obtain measurements directly from other elevation views (e.g. heights of doors, windows, walls, etc.). So the first step is to determine which measurements we already have.
- The next step is to determine the missing measurements and we would have to use the scale that we had previously calculated as well as measurements from the floor plan.
- Once we have all of the required measurements converted it is a wise idea to start with the lowest line and 'build' our drawing from the bottom up.

## Maps and plans (plans and scale)

### Additional questions

1. Construct accurate bar graphs for the following scales:
  - 1.1 1 : 500 (The bar scale must go up in 10 m increments.)
  - 1.2 1 : 10 000 (The bar scale must go up in 200 m increments.)
2. List TWO advantages of a bar graph relative to a number scale.
3. The diagram of the Wendy house below is drawn to scale. Use the drawing and the given measurement to answer the following questions:

Left Side View

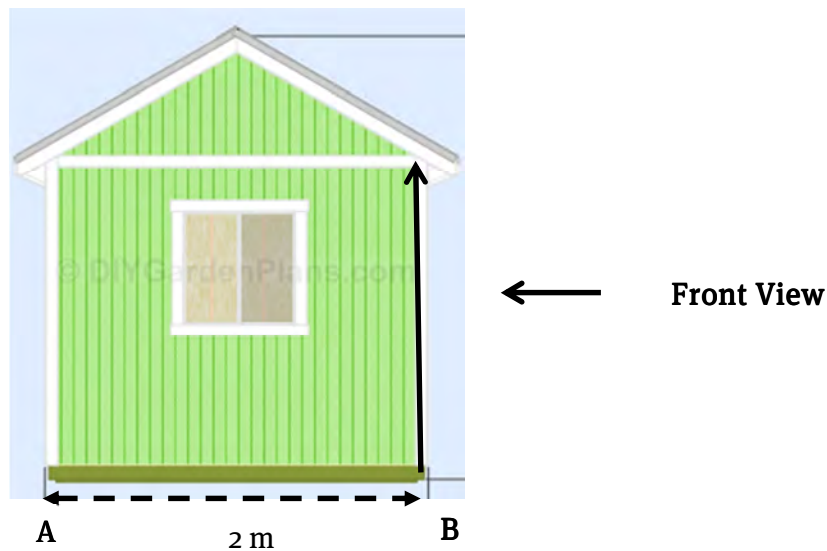

- 3.1 Measure the distance from point A to point B in the diagram. Answer in cm.
- 3.2 Use your measurement from Question 3.1 to calculate the scale of the diagram. Express the scale in the form 1: ... (Round your answer to the nearest 10).
- 3.3 The view in the diagram is the Left side view. The builder of the Wendy house would like to draw the Front view (the position is indicated by the arrow in the diagram).
  - 3.3.1 List at least FOUR measurements that will be the same in the Front view as in the Left side view.
  - 3.3.2 One measurement that cannot be seen from the Left side is the width of the front of the Wendy house. It is 3,6 m wide. Use the scale you calculated in Question 3.2 to convert 3,6 m to the same scale as the above diagram.



## Maps and plans (plans and scale)

- 3.4 Using relevant measurements from the above diagram and the facts below, draw an accurate Front view of the Wendy house to the same scale as the diagram above.

Extra notes: a. The Front view has a door in it which is the same width as the window in the above diagram and the top of the door is the same height as the top of the window in the diagram.

b. There is a window to the left of the door that has the same dimensions and height above the floor as the window in the diagram above.

## Maps and plans (plans and scale)

### Answers

1. 1.1 A scale of 1 : 500 means that 1 cm on the plan is 500 cm in real life.

This means that 1 cm on the plan is 5 m in real life.

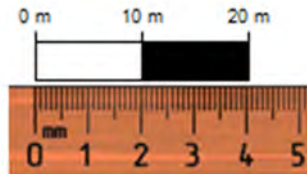

- 1.2 A scale of 1 : 10 000 means that 1 cm on the map represents 10 000 cm in real life. This means that 1 cm on the map represents 100 m in real life.

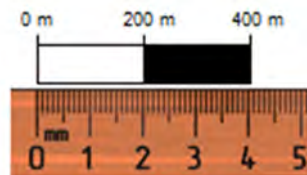

2. A bar graph will keep its proportions when a map or plan is photocopied. A bar graph can be used to estimate distance with a simple finger measurement or a ruler (whereas a scale will involve calculation and conversion).

3. 3.1 5,0 cm

- 3.2 2 m = 200 cm

$$\text{Scale} = 200 \text{ cm} \div 5,0 \text{ cm} = 40$$

Therefore scale is approximately 1: 40.

- 3.3 3.3.1 The height of the top of the roof

The height to the bottom of the roof

The height of the  
bottom of the  
window

The height of the  
top of the window.

- 3.3.2 3,6 m = 360 cm

Therefore in the  
plan, it will be 360  
 $\text{cm} \div 40 = 9 \text{ cm}$

- 3.4

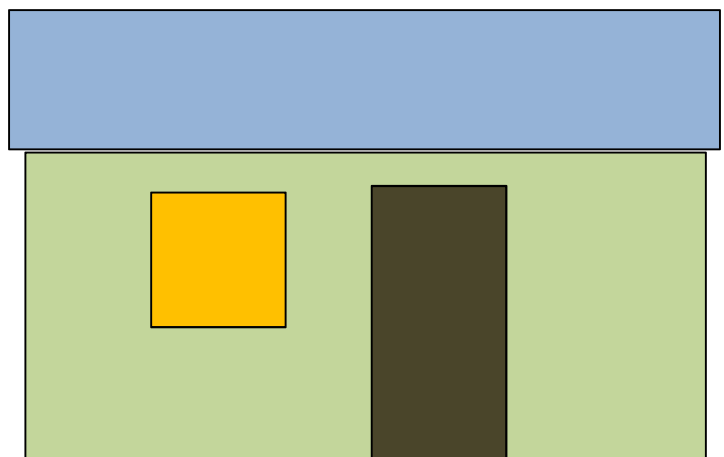

## Section 1: Probability theory

---

(LB pages 270-277)

### Overview

The content of this *Probability* Application Topic is drawn from pages 91-93 in the CAPS document.

As stipulated in the CAPS document, Grade 12 learners need specifically to be able to:

- recognise the difference where the outcome of one event impacts on the outcome of another and situations where the two outcomes do not impact each other.
- identify outcomes for compound events in various contexts using tree diagrams and two-way tables.

### Contexts and integrated content

- Contexts include situations involving probability including national lotteries, gambling scenarios, risk assessments, etc.
- There is a link to the *Data handling* Application Topic through the use of data in analysing the possible outcomes of various situations.

Probability refers to the likelihood or *possibility* of an event occurring. Some events lend themselves to a mathematical method of determining how likely an event is. This method is as follows:

$$P(\text{event}) = \frac{\text{number of ways in which an event can occur}}{\text{total number of possible outcomes for the event}}$$

### Probabilities of multiples events

- When there is a **sequence** of events (e.g. select one ball *and then...*), we **multiply** the probabilities.
- When we are given **options** of two or more outcomes (e.g. you can win this way *or that way*), we **add** the probabilities.

### Example

A simple prediction game involves a bag that contains two red balls and three

## Probability

green balls. The probability of a sequence of two balls being selected (first one ball and then a second ball) can be shown in the following tree diagrams (Red ball = R, Green ball = G):

**Situation 1**

With each ball being drawn and replaced in the bag immediately:

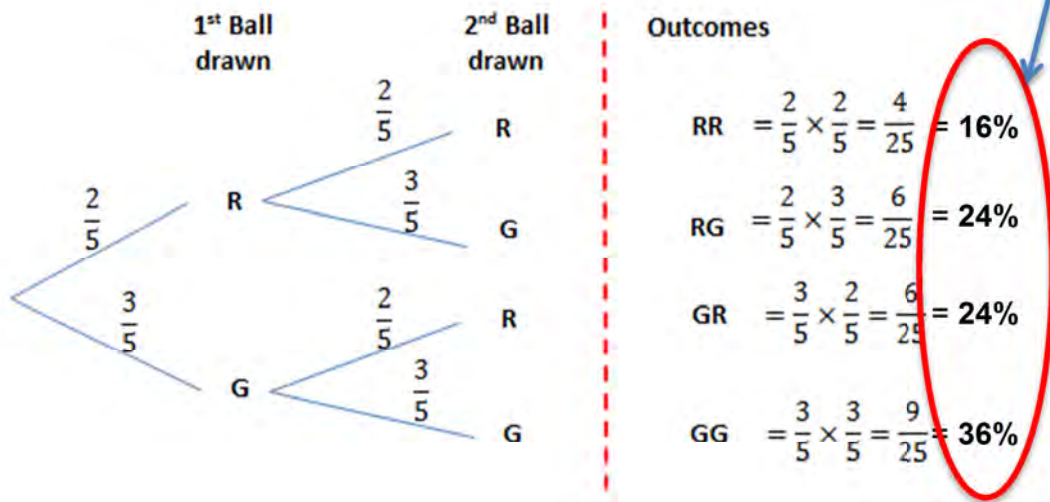
**Questions related to situation 1**

1.1 What is the probability that the first ball drawn is a red ball?

**Answer:** 2 out of 5 balls are red, therefore  $\frac{2}{5}$  or 0,4 or 40%

1.2 What is the probability that the second ball drawn is a red ball if the first ball was a red ball?

**Answer:** The first ball was replaced, so there are still 5 balls in the bag and 2 of them are red. Therefore  $\frac{2}{5}$  or 0,4 or 40%

1.3 What is the probability that both balls are red?

**Answer:** Two *events* have to occur for this *outcome* to happen. The first ball must be red **and then** the second ball must also be red. This is a **sequence** of events and so we **multiply** the probabilities:

$$RR = \frac{2}{5} \times \frac{2}{5} = \frac{4}{25}$$

1.4 What is the probability that at least one of the balls drawn is a green ball?

**Answer:** Looking at the outcomes there are three that involve at least one green ball (RG, GR, GG). All three are valid and so we **add** the probabilities. It is

## Probability

advisable that the probabilities are converted to percentage before adding:

$$\text{Total probability} = RG + GR + GG = 24\% + 24\% + 36\% = 84\%$$

### Situation 2

With each ball being drawn and not replaced in the bag:

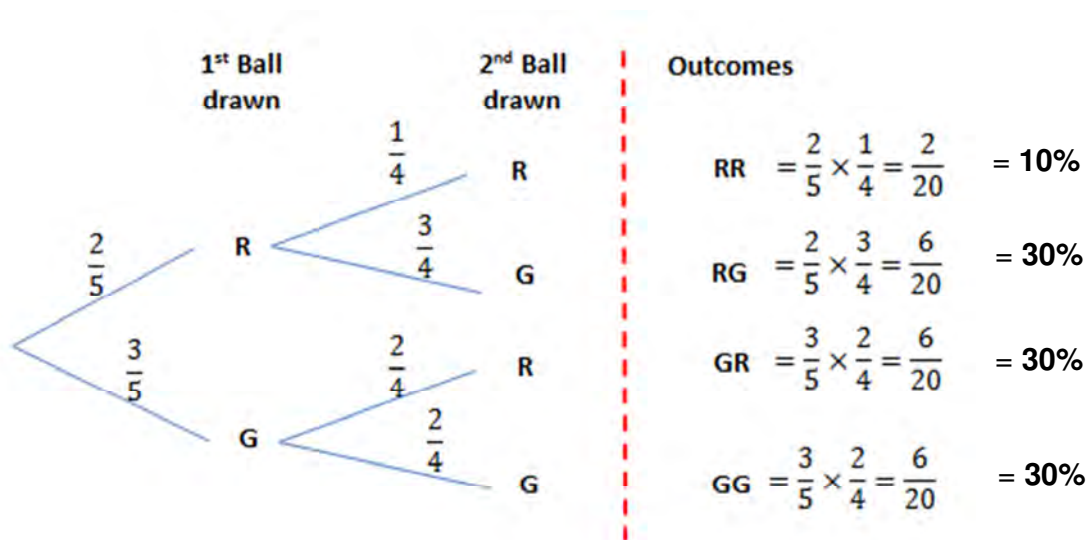

### Questions related to situation 2

2.1 What is the probability that the first ball drawn is a red ball?

**Answer:** 2 out of 5 balls are red, therefore  $\frac{2}{5}$  or 0,4 or 40%

2.2 What is the probability that the second ball drawn is a red ball if the first ball was a red ball?

**Answer:** The first ball was not replaced, so there are only 4 balls in the bag and 1 of them is red. Therefore  $\frac{1}{4}$  or 0,25 or 25%

2.3 What is the probability that both balls are red?

**Answer:** Two *events* have to occur for this *outcome* to happen. The first ball must be red **and then** the second ball must also be red. This is a **sequence** of events and so we **multiply** the probabilities:

$$RR = \frac{2}{5} \times \frac{1}{4} = \frac{2}{20}$$

2.4 What is the probability that at least one of the balls drawn is a green ball?

**Answer:** The outcomes that at least one green ball are RG, GR **and** GG.

Therefore:

$$\text{Total probability} = RG + GR + GG = 30\% + 30\% + 30\% = 90\%$$

## Probability

So by not replacing the first ball (of whichever colour), it became more likely that at least one of the two balls selected would be a green ball.

### Converting a probability to a ratio

It is often easier to understand a probability when it is written as a ratio (e.g. 2 out of every 25 people will get the flu this winter).

### Example

What is the likelihood of a person getting at least 3 numbers correct in the lottery?  
(For more information on the calculation refer to Chapter 11 in the Learner's Book.)

$$\text{Probability} = \frac{6}{49} \times \frac{5}{48} \times \frac{4}{47} = \frac{6 \times 5 \times 4}{49 \times 48 \times 47} = \frac{120}{110\,544} = \frac{1}{921,2}$$

Divide the top by 120 to reduce it to 1.

Also divide the bottom by 120 to maintain the ratio.

Therefore the likelihood is that 1 in every 921 people who play the lottery *should* at least choose 3 numbers correctly. But this is only a prediction.

## Section 2: Prediction

---

(LB pages 278-283)

### Overview

The content of this *Probability* Application Topic is drawn from page 92 in the CAPS document.

As stipulated in the CAPS document, Grade 12 learners need specifically to be able to:

- recognise the difference where the outcome of one event impacts on the outcome of another and situations where the two outcomes do not impact each other.
- recognise the difference between predictions based on knowledge and those based on long-term trends in data.

### Contexts and integrated content

- Contexts include situations involving probability including national lotteries, gambling scenarios, risk assessments, etc.
- There is a link to the *Data handling* Application Topic through the use of data in analysing the possible outcomes of various situations.

While we would like to think of the calculation of probability as a guaranteed predictor it only states how *likely* an event is. No guarantee is given.

The more information that the prediction is based on, the more accurate it will be. There are generally two approaches to generating probabilities for prediction:

- trends in historical information
- specialised knowledge

### Betting odds: skills

Betting odds are a different way to represent probabilities. They are shown as a ratio of the probability of not winning to the probability of winning like this:

*Betting odds: not winning / winning:*

## Probability

### Example

A 20% chance of winning = 80% chance of *not* winning (100% – 20%).  
Betting odds: 80 / 20 which we simplify to **4 / 1**.

### Example

The odds of a team winning are 5 / 13, this means that the probability of them winning is:

$$\text{Probability} = \frac{\text{Winning outcomes}}{\text{Total outcomes}} = \frac{5}{(5+13)} = 0,2692 = 26,92\% \text{ of winning}$$

### Betting odds: an important note

Betting odds (as seen on betting sites or in the newspaper) are *not the true odds* (true probability) of an event occurring. When adding the probabilities of all possible outcomes, we should get a total of 100%. Bookmakers add a small percentage to each bet in order to make a profit:

### Example

In a recent match between the New Zealand and Sri Lankan cricket teams the odds were: Sri Lanka winning: 4 / 5, New Zealand winning: 13/2; Draw: 8/5

These converted to the following percentages: 55,55%, 13,3%, 38,5% which total 107,35%. So the bookmaker should make 7,35% profit.

### Betting odds: worked example

The Bizhub Highveld Lions and the Nashua Cape Cobras played in a Momentum 1-day cricket match on Sunday, 24 November 2012. Who should win the match?

**The betting odds** before the game were: Lions to win: 4 / 5 ; Cobras to win 1 / 1.

$$\text{Probability of Lions winning: } \frac{5}{(4+5)} = 0,5555 = 55,6\%$$

$$\text{Probability of Cobras winning: } \frac{1}{(1+1)} = 0,50 = 50,0\%$$



## Probability

Note that the two percentages add up to 105,6% due to the profit made by the bookmakers. However the two percentages together seem to indicate that the Lions have a slightly higher chance of winning the match.

### Historical information

- Looking at the matches that they have played so far this year:  
**Lions:** won 5 out of 7 matches (71,4% of matches won)  
**Cobras:** won 3 out of 6 matches (50,0% of matches won)  
(The Lions have a much higher percentage of wins.)
- Looking at the last three matches (most recent last):  
**Lions:** Loss – No result – Win (1 out of the last 3 matches = **33,3 % won**)  
**Cobras:** Loss – Win – Win (2 out of the last 3 matches = **66,7% won**)  
(The Cobras have more recent wins than the Lions and could be carrying a winning momentum into this match.)
- These two teams have already played each other earlier in the season and the Lions narrowly won that match. This could indicate that the Lions have a slight advantage.

### Specialised knowledge

A person could go down to the match early and watch the players as they prepare and see if any of their key players are carrying a recent injury or they could have some other piece of information that could change the outcome of the match.

**Result:** The Nashua Cape Cobras won the match quite comfortably in the end.

Sometimes in sport it comes down to the best team on the day.

## Section 3: Expressions of probability in the press

---

(LB pages 284-285)

### Overview

The content of this *Probability* Application Topic, is drawn from page 94 in the CAPS document.

As stipulated in the CAPS document, Grade 12 learners need specifically to be able to:

- Evaluate and critique the validity of expressions of probability represented in newspapers and other sources of information.

### Contexts and integrated content

- Contexts include situations involving probability including national lotteries, gambling scenarios, risk assessments, etc.

When probability is used in the press, it is stated in a way that allows it to be accessible to the general population. Sometimes there is a calculated value (e.g. 60% chance of showers in Pietermaritzburg overnight), while at other times only words are used (e.g. 'It is likely that the match will go ahead as planned.').

When analysing probability in the press or other media, consider the following:

### Calculated values

- How accurate are the sources of data that were used to make the calculation?
- How large was the sample that was used to gather the data? (e.g. if only five people were asked a question and three answered that they agreed, this means that 60% agreed! But this is far too small a sample size.)
- How trustworthy is the person or organisation that performed the calculation (e.g. The South African Weather Service is a reliable source for weather, but your uncle's aching knee is not.)

### Descriptions of probability

- The word 'likely' could refer to any probability from 50,1% to 100%. More information is needed in this case.
- Similarly the word 'unlikely' refers to any probability from 0% to 49,9% and so more information is required.
- 'There is a likelihood' or 'there is a possibility' are very ambiguous terms because every event has a likelihood or a possibility. Some have a high probability and some not. More information is required.

## Probability

## Additional questions

1. In order to win the South African National Lottery, you need to select six winning numbers from 1 to 49. These numbers can be selected in any order. The following information is from a Lotto draw:

Number of Winners		Payout per Winner
Div 1 (Six Correct Numbers)	1	R 25,000,000.00
Div 2 (Five Correct Numbers + Bonus Ball)	4	R 176,172.00
Div 3 (Five Correct Numbers)	201	R 7,888.00
Div 4 (Four Correct Numbers + Bonus Ball)	641	R 1,374.00
Div 5 (Four Correct numbers)	10953	R 269.00
Div 6 (Three Correct Numbers + Bonus Ball)	17940	R 108.00
Div 7 (Three Correct Numbers)	199929	R 31.00

- 1.1 How many people won by choosing Three Correct Numbers?
- 1.2 The probability of picking three correct numbers is 0,10855%. How many of the 26 099 614 people who played that week *should* have won? Show all working.
- 1.3 Why is there such a large difference between the number of people that *should* have won and the number of people who *actually* won?
- 1.4 The National Lottery website gives the statistics of the number of times each number has come up. Here are the numbers of times each of the numbers above had come up in the past:

4 : 145	5 : 150	8 : 171	13 : 159	25 : 142	39 : 157
---------	---------	---------	----------	----------	----------

- 1.4.1 The average amount of times each number (from 1 to 49) has been drawn is 159 times. Do you think that it is odd that the number 25 has only come up 142 times? Give a reason for your answer.

## Probability

- 1.4.2 How could someone use the information on the number of times that each number has come up to choose their numbers? Give reasons for your answer.
2. A man bought a fishing cottage. He managed to afford it because he won two prizes in local lotteries.
- 2.1 The first lottery was a lucky ticket draw. 1257 tickets were sold and his ticket was the lucky one drawn (he only bought one ticket). What was the probability that he would win? (Give the answer as a percentage).
- 2.2 In the second lottery, he had to guess the order of coloured balls coming out of a bag *without any being returned to the bag*. In the bag there were 5 red balls, 7 black ones, 3 white balls, 4 green ones and a blue one. The winning sequence was: *Red – Green – Red*
- 2.2.1 Did all of the colours have an equal likelihood of being drawn from the bag? Give a reason for your answer.
- 2.2.2 Calculate the probability that a red ball would have been drawn from the bag first. Answer as a percentage.
- 2.2.3 Calculate the probability that the second ball drawn from the bag was a green one. Answer as a percentage.
- 2.2.4 Would it have become more likely or less likely for a green ball to be drawn from the bag if the first ball drawn had been returned to the bag? Prove your answer with calculations.
- 2.2.5 Calculate the probability that the first two balls drawn were *Red and then Green*.
- 2.2.6 Would it have been more likely for the first two balls drawn to both have been Red than for the balls to have been Red and then Green? Prove your answer using calculations.
- 2.2.7 What would the probability be for the following sequence? Give a reason for your answer:  
*Blue – Green – Blue*

## Probability

- 2.3 He bought the cottage at St. Lucia because he saw this contingency table in a fishing magazine and he loves to eat trout.

**Where are they catching fish?**

(no. of fish caught in these areas in November 2008)

Fish ↓	Place ⇨	Umzinto	St. Lucia	Pelling's Drift	Totals
<b>Barble</b>		563	232	<b>B</b>	1221
<b>Trout</b>		53	356	684	1093
<b>Grey-finned Hack</b>		0	173	156	329
<b>Red-faced Snoot</b>		5	<b>A</b>	85	<b>C</b>
<b>Totals</b>		621	797	1351	2769

- 2.3.1 Calculate the values for A, B & C.
- 2.3.2 Besides trout, the man also enjoys grey-finned hack. Which fishing spot gives him the best chance of catching either a trout or a hack? (Show all calculations)
- 2.3.3 In his choice, he also considered that he does not like to catch barble. Which of the spots gives him the best chance to NOT catch barble?
- 2.3.4 Which fishing spot gives him the best chance to catch a trout and NOT catch a barble?
3. The following odds were given for a match between two football teams:
- Super Stars*       $4/5$  to win
- Brilliant Boys*       $5/7$  to win
- 3.1 According to the odds above, which team is more likely to win?
- 3.2 According to the odds above, do either of the teams have a large likelihood of winning? Give reasons for your answer.

## Answers

---

1. 1.1 199 929
- 1.2  $0,10855\%$  of 29 099 614 =  $0,10855 \div 100 \times 29\ 099\ 614$   
 $= 31\ 857,63 \approx 31\ 858$  people
- 1.3 Probability is only a predictor and does not *guarantee* that a certain event will happen.
- 1.4 1.4.1 Ideally all of the numbers should be drawn the same number of times and the more Lotto draws there are over time, the more this should be true. However, we can expect some numbers to randomly come up more often than others due to it being a *random* draw.
- 1.4.2 There are two possible approaches: Often and Seldom  
 In the 'Often' approach, a person would choose the numbers that have come up most often believing that they would continue to do so.  
 In the 'Seldom' approach, a person would choose the numbers that have come up the least often in the belief that they are due to come up the same amount of times as the average eventually so they will have some 'catching up' to do.  
 Both approaches are false. As the draws are random the numbers will not come up according to a predictable pattern.
2. 2.1  $1 \div 1\ 257 \times 100 = 0,08\%$  chance of winning.
- 2.2 2.2.1 No, there were different numbers of each colour. In order for them to all have the same chance, there would have to be the same number of each colour in the bag.
- 2.2.2 5 out of 20 =  $5 \div 20 \times 100 = 25\%$  chance.
- 2.2.3 4 out of 19 =  $4 \div 19 \times 100 = 21,05\%$
- 2.2.4 It would have become less likely. The higher the denominator, the lower the number, so the more balls still in the bag, the lower the chance that the green ball would have been drawn:  
 4 out of 20 =  $4 \div 20 \times 100 = 20\%$  (which is less than 21,05% calculated before).
- 2.2.5 Sequence means that we multiply the probabilities:  
 $(5 \div 20) \times (4 \div 19) \times 100 = 5,26\%$
- 2.2.6 Probability of Red; Red =  $(5 \div 20) \times (4 \div 19) \times 100 = 5,26\%$   
 Therefore it would have been the same likelihood.

## Probability

2.2.7 o. There is only one blue ball in the bag so it would be impossible for two blue balls to be drawn (unless the first was returned to the bag after it was drawn).

2.3 2.3.1  $A = 797 - (173 + 356 + 232) = 36$

$$B = 1\,351 - (684 + 156 + 85) = 426$$

$$C = 2\,769 - (1\,221 + 1\,093 + 329) = 126$$

2.3.2 Umzinto =  $(53 + 0) \div 621 \times 100 = 8,53\%$

$$\text{St. Lucia} = (173 + 356) \div 797 \times 100 = 47,55\%$$

$$\text{Pelling's Drift} = (684 + 156) \div 1\,351 \times 100 = 62,18\%$$

Therefore Pelling's Drift gives him the best chance of catching his favourite fish.

2.3.3 Umzinto =  $563 \div 621 \times 100 = 90,66\%$

$$\text{St. Lucia} = 232 \div 797 \times 100 = 29,11\%$$

$$\text{Pelling's Drift} = 426 \div 1\,351 \times 100 = 31,53\%$$

Therefore St. Lucia gives him the best chance of not catching his least favourite fish.

2.3.4 Umzinto is clearly not a consideration, to let us look at the other two locations. In this case there are two events that affect each other in a sequence and so we multiply their probabilities:

$$\text{St. Lucia} = 47,55\% \times 29,11\% = 0,4755 \times 0,2911 = 0,1384 = 13,84\%$$

$$\text{Pelling's Drift} = 62,18\% \times 31,53\% = 0,6218 \times 0,3153 = 0,1961 = 19,61\%$$

Therefore Pelling's Drift is the better spot overall.

3 3.1 Super Stars =  $4 \div 9 = 0,44$

$$\text{Brilliant Boys} = 5 \div 12 = 0,42$$

These two teams are fairly evenly matched, but the bookmakers seem to be giving Super Stars a slight edge.

3.2 Both have a probability of less than 50% for the win. This would seem to indicate that a draw is likely.

## Maps and plans (models)

### Section 1: Creating a 3-D model

---

(LB pages 290-293)

#### Overview

The content of this section on Creating a 3-D Model is part of the *Maps, plans and other representations of the physical world* Application Topic, is drawn from pages 79-80 in the CAPS document.

As stipulated in the CAPS document, Grade 12 learners need to be able to:

- determine the most appropriate scale in which to draw/construct a plan.
- make and use 2-dimensional and 3-dimensional models of buildings from given or constructed 2-dimensional floor and elevation plans.

#### Contexts and integrated content

Contexts include more complex projects in a community (e.g. an RDP House).

You will not be asked to construct a model of a structure for your final examinations, but might be asked to calculate scaled measurements and to decide on the most appropriate scale to construct a model. You will need to review the skills needed for working with scale that were covered in Chapters 5 and 10.

#### Determining the appropriate scale

If you are asked to determine the most appropriate scale to fit into a given space:

- Use one of the given scales to convert the largest dimension (either length or breadth) of the given plan or item.
- If you are not given a scale then start with an easy one (e.g. 1 : 100 for large structures or 1 : 5 for a small item (e.g. a toy car)). Once you have performed the calculation on the dimension adjust your scale appropriately (e.g. if the calculated dimension is too small, then make the scale larger (1 : 50 is a larger scale than 1 : 100)).
- Once you have determined the best scale for your chosen dimension, *use the same scale* to convert the other dimension (i.e. if you converted the length, then convert the breadth, etc.) Remember that the model must have the same scale throughout otherwise it will not be *in proportion*.
- Once the best scale is determined, it is simply a matter of working with that scale to convert the real life dimensions according to the scale.
- When constructing a model, we construct the base of the model first. This has two advantages: it sets the limits for the model and it gives a basic area to paste the remaining parts of the model onto (e.g. walls, doors, etc.)



## Maps and plans (models)

### Additional questions

- Which of the following scales is the largest? Give a reason for your answer.  
 $1 : 80$        $1 : 10$        $1 : 20$
- Which of the above scales would be best to create a scale model for the following items? Show calculations to prove your answer:
  - Car (length of a car is 3,4 m).
  - Television (width of a television is 80 cm).
- A homeowner is attempting to build a cottage. He intends to build a scale model of the building in order to plan the layout and to check the dimensions of the rooms. The South elevation and top view are pictured below (each is to different scales):

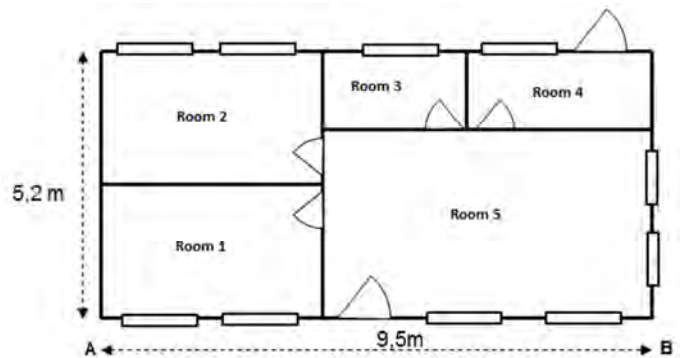
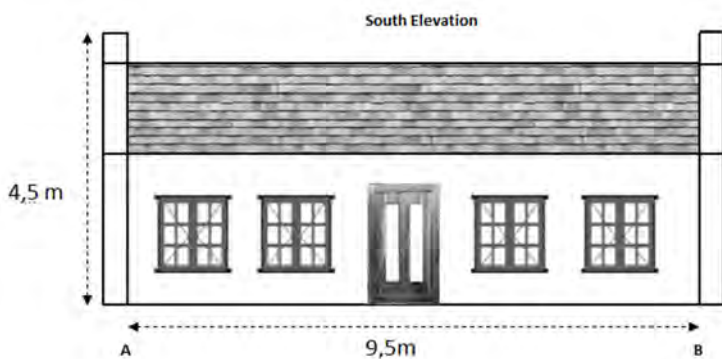

- An A4 page is 29,7 cm long and 21 cm wide. Which of the following scales would be the best scale to choose if the floor plan of the model would need to fit onto an A4 page? Prove your answer by calculation.  
 $1 : 50$        $1 : 100$        $1 : 150$
- Calculate the height of the model using your chosen scale. Answer in cm.
- Will this be a sensible scale with which to see enough detail? Give a reason for your answer.

## Maps and plans (models)

## Answers

1. 1 : 10 is the largest scale. The reason is that a scale of 1 : 10 means a measurement of 1 cm on the plan represents 10 cm in real life which means that the plan view will be larger (10 cm in real life is represented by 1 cm, whereas a scale of 1 : 20 means that 10 cm in real life is represented by 0,5 cm on the plan so it will be smaller).
2. 2.1 3,4 m = 340 cm. According to the various scales:  
1 : 10 :  $340 \text{ cm} \div 10 = 34 \text{ cm}$  on the plan (perhaps a bit large)  
1 : 20 :  $340 \text{ cm} \div 20 = 17 \text{ cm}$  on the plan (a good size)  
1 : 80 :  $340 \text{ cm} \div 80 = 4,25 \text{ cm}$  on the plan (perhaps too small)  
2.2 1 : 10 :  $80 \text{ cm} \div 10 = 8 \text{ cm}$  on the plan (a good size)  
1 : 20 :  $80 \text{ cm} \div 20 = 4 \text{ cm}$  on the plan (too small)  
1 : 80 :  $80 \text{ cm} \div 80 = 1 \text{ cm}$  on the plan (very small - too hard to draw)
3. 3.1 Both of the floor plan's dimensions would need to fit comfortably onto the page:  
1 : 50 scale:      Length of plan:  $950 \text{ cm} \div 50 = 19 \text{ cm}$   
                         Width of plan:  $520 \text{ cm} \div 50 = 10,4 \text{ cm}$   
1 : 100 scale:    Length of plan:  $950 \text{ cm} \div 100 = 9,5 \text{ cm}$   
                         Width of plan:  $520 \text{ cm} \div 100 = 5,2 \text{ cm}$   
We can stop there as the 1 : 150 scale would make the drawing even smaller. The 1 : 50 scale would work perfectly as both of the dimensions would fit onto the page (if the page was turned sideways (landscape orientation)).  
3.2 4,5 m = 450 cm  
On plan:  $450 \text{ cm} \div 50 = 9 \text{ cm}$   
3.3 Yes, this scale is large enough to see enough detail yet small enough to build a sensibly sized model.

## Exam analysis

### Introduction

In this part of the study guide you will be provided with an analysis of the Paper 1 and Paper 2 practice examination papers provided on pages 294-298 in the Learner's Book. The intention of this exam analysis is to provide you with insight into

- how the examination papers for this subject are structured
- how the different levels of the Mathematical Literacy taxonomy are used to inform the structure of the examinations
- how to determine the intention of each question and the content and method needed to complete each question.

Before the exam analysis is provided, the discussion below will first highlight the structure of the examination papers in Mathematical Literacy.

### Required structure of examinations

---

#### 1. Difficulty level of each examination paper

There are two examination papers in Grade 12 in Mathematical Literacy. These two examinations are differentiated according to difficulty (i.e. cognitive demand):

- Paper 1 is a 'basic skills' paper and the intention of this paper is to assess whether learners understand basic concepts and skills. The contexts used in this paper must be drawn from the contexts described in the CAPS curriculum document.
- The Paper 1 examination paper in the Learner's Book appears on pages 294-296.
- Paper 2 is an 'applications' paper and the intention of this paper is to assess whether learners can use their knowledge and skills in order to make sense of a variety of real-world contexts. The contexts used in this paper can be drawn from any scenario, including those listed in the CAPS curriculum document.
- The Paper 2 examination paper in the Learner's Book appears on pages 296-298.

In Mathematical Literacy there is a four-level taxonomy that determines the level of cognitive demand of a question in an examination. The table on the next page

## Exam analysis

shows the percentage of marks in the Paper 1 and Paper 2 examination papers that must be allocated to each level of the taxonomy.

Grades 11 and 12			
	Paper 1	Paper 2	Overall allocation
Level 1: Knowing	60% ( $\pm 5\%$ )		30% ( $\pm 5\%$ )
Level 2: Applying routine procedures in familiar contexts	35% ( $\pm 5\%$ )	25% ( $\pm 5\%$ )	30% ( $\pm 5\%$ )
Level 3: Applying multi-step procedures in a variety of contexts	5%	35% ( $\pm 5\%$ )	20% ( $\pm 5\%$ )
Level 4: Reasoning and reflecting		40% ( $\pm 5\%$ )	20% ( $\pm 5\%$ )

Notice that Paper 1 contains questions positioned primarily at the two lowest levels (Level 1 and Level 2) of the taxonomy. This is why the paper is classified as a basic skills paper. Paper 2 contains questions positioned primarily at the two highest levels of the taxonomy (Levels 3 and 4), which is why the paper is classified as an applications paper. However, Paper 2 also contains a smaller percentage of questions positioned at Level 2 of the taxonomy, designed to provide scaffolding and facilitate access to the more complex Level 3 and 4 questions.

## 2. Question structure of each examination paper

The diagrams below illustrate the structure of the Paper 1 and 2 examinations.

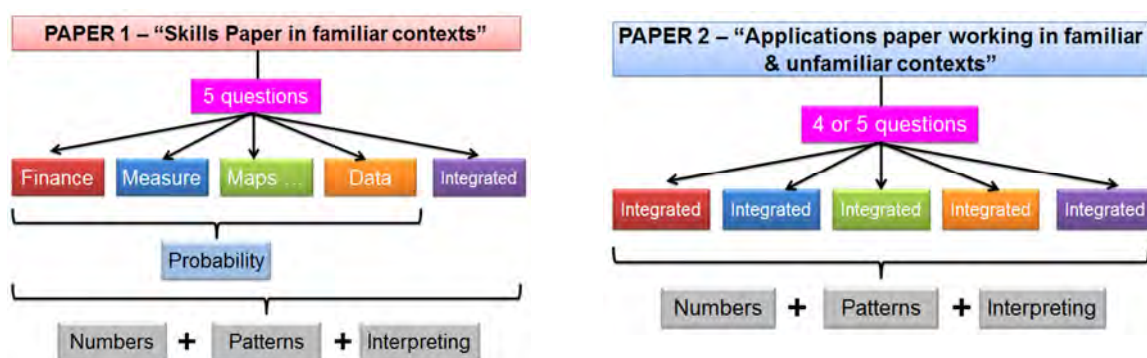

In Paper 1 there must be a question allocated to each of the first four Application Topics outlined in the curriculum. The final question must then draw on content and contexts integrated from a range of different Application Topics. The topic of Probability must be assessed in the context of one or more of the other questions. The Basic Skills Topics will be assessed in the context of the other questions and

## Exam analysis

no individual questions are allocated to the assessment of the contents of the Basic Skills Topics.

In Paper 2 each question must draw on integrated content, contexts and skills drawn from across the various Application Topics. As in Paper 1, the Basic Skills Topics will be assessed in the context of the other questions and no individual questions are allocated to the assessment of the contents of the Basic Skills Topics.

### 3. Mark allocations for examinations in Grades 10, 11 and 12

The table below shows the mark and time stipulations for Mathematical Literacy examinations in Grades 10, 11 and 12.

	GRADE 10		GRADE 11		GRADE 12	
TERM 1	Control Test		Control Test		Control Test	
TERM 2	Paper 1 1 hour (50 marks)	Paper 2: 1 hour (50 marks)	Paper 1: 1½ hours (75 marks)	Paper 2: 1½ hours (75 marks)	Paper 1: 2 hours (100 marks)	Paper 2: 2 hours (100 marks)
TERM 3	Control Test		Control Test		Control Test	Control Test
					Paper 1: 3 hours (150 marks)	Paper 2: 3 hours (150 marks)
TERM 4	Paper 1 1½ hours (75 marks)	Paper 2 1½ hours (75 marks)	Paper 1: 2 hours (100 marks)	Paper 2: 2 hours (100 marks)	Nationally set examination	
					Paper 1: 3 hours (150 marks)	Paper 2: 3 hours (150 marks)

The examination papers in the Learner's Book reflect the structure of end-of-year examination papers for Grade 12. The examination papers are both out of 150 marks with a time allocation of 3 hours per paper. The examination papers also assess the content covered for the whole curriculum (and/or for the contents of the whole Learner's Book).

### 4. Explaining the exam analysis

An exam analysis is provided in the pages that follow. This exam analysis will provide guidance on:

- the topic and section to which each question relates in the curriculum
- the content, skills or contexts required to answer each question
- the taxonomy level (level of difficulty or cognitive demand) of each question
- the mark allocation of each question.

## Exam analysis

To begin with, it is useful to consider the following table which shows the percentage of marks allocated to each of the levels of the taxonomy in both examination papers.

Taxonomy Level	Paper 1		Paper 2		Combined	
	% of paper	Required	% of paper	Required	%	Required
Level 1 – Knowing	49%	60% ( $\pm 5\%$ )	4%	0% ( $\pm 5\%$ )	26,5%	30%
Level 2 – Routine procedures	43%	35% ( $\pm 5\%$ )	24%	25% ( $\pm 5\%$ )	33,5%	30%
Level 3 – Multi-step procedures	8%	5% ( $\pm 5\%$ )	27%	35% ( $\pm 5\%$ )	17,5%	20%
Level 4 – Reasoning and reflecting	0	0% ( $\pm 5\%$ )	45%	40% ( $\pm 5\%$ )	22,5%	20%

Analysis of the values in this table reveals the following:

- In Paper 1:
  - The allocation of Level 1 questions is below the required percentage.
  - The allocation of Level 2 questions is quite high above the required percentage.
  - This suggests that the examination paper is possibly more difficult than it should be.
- In Paper 2:
  - There is an allocation of marks to Level 1 questions, which should not be in the paper.
  - The allocation of Level 3 questions is significantly below the required percentage.
  - This suggests that the examination paper is possibly easier than it should be.
- Both papers combined:
  - Although the information in the analysis grid above suggests that Paper 1 is slightly more difficult and Paper 2 slightly easier than they ideally should be, the combination of the two papers gives an allocation of marks at the different levels of the taxonomy that falls within the required stipulations.
  - This suggests that when the marks for both papers are combined the result should be a reasonably accurate reflection of the ability / performance of the learners.

## Grade 12 Mathematical Literacy

## Paper 1

## (Basic skills paper)

150 Marks

3 Hours

Read these instructions carefully.

- Answer all the questions.
- It is advisable to show all working and to work neatly.
- You may use a calculator.
- Drawings are NOT to scale (unless otherwise stated).

### Question 1 – Incandescent vs. fluorescent bulbs

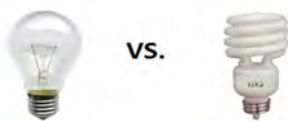

One of the ways in which South Africans are saving electricity is by switching from traditional incandescent light bulbs to long-life light bulbs. Below is a table comparing one of each kind that gives off the same amount of light:

	Incandescent (Regular)	Fluorescent (Long-life)	Units
Power	60	15	Watts
Bulb life	1 000	10 000	Hours
Bulb cost	R10,00	R19,99	Rands

- 1.1 According to the table, how many hours will a fluorescent bulb last? (1)
- 1.2 A normal light is used for an average of 6 hours per day. Using your previous answer, how many days should a fluorescent bulb last for? Round your answer to the nearest day. (3)

## Basic skills paper

1.3 Which bulb is cheaper to buy? (1)

1.4 Electricity is measured in units of kWh (kilowatt-hours) and the following formula is used:

$$\text{Units of electricity} = \text{kiloWatts} \times \text{hours}$$

1.4.1 Convert the power of one incandescent bulb from Watts to kiloWatts (kW). (2)

1.4.2 Using the above formula, calculate the units of electricity used by one fluorescent bulb in a week. The bulb is in use 6 hours per day and a fluorescent bulb has a power rating of 0,015 kW. (3)

1.4.3 A kettle uses approximately one unit of electricity every time it boils. For how many hours would a fluorescent bulb have to remain on in order to use the same amount of electricity? (Answer to the nearest hour.) (5)

1.5 To calculate the total cost of using each bulb, we can use the following formulae which include the cost of electricity:

Incandescent bulb:  $\text{Total Cost} = \text{R}0,036 \times \text{Hours} + \text{R}10,00$

Fluorescent bulb:  $\text{Total Cost} = \text{R}0,009 \times \text{Hours} + \text{R}19,99$

1.5.1 Identify which variable is the independent variable in the above equations. Give a reason for your answer. (2)

1.5.2 Why is there '+ R10,00' at the end of the Incandescent bulb equation? (1)

1.5.3 Why is the rate used for the fluorescent bulb a quarter of the rate used for the incandescent bulb? (The rate is the value by which the hours is multiplied.) (1)

1.6 The formulae were used to complete the following table:

No. of hours	0	100	250	350	500	1.6.3
Total cost of using regular bulb	R10,00	R13,60	1.6.1	R22,60	R28,00	R35,92
Total cost of using long-life bulb	R19,99	R20,81	R22,24	1.6.2	R24,49	R26,47

Use the formulae to work out the missing values for 1.6.1, 1.6.2 and 1.6.3 from the table. Show your working in your answer books. (9)



## Basic skills paper

- 1.7 Copy the following set of axes into your book and use the values in the above table to draw two graphs (one for each type of bulb). (6)

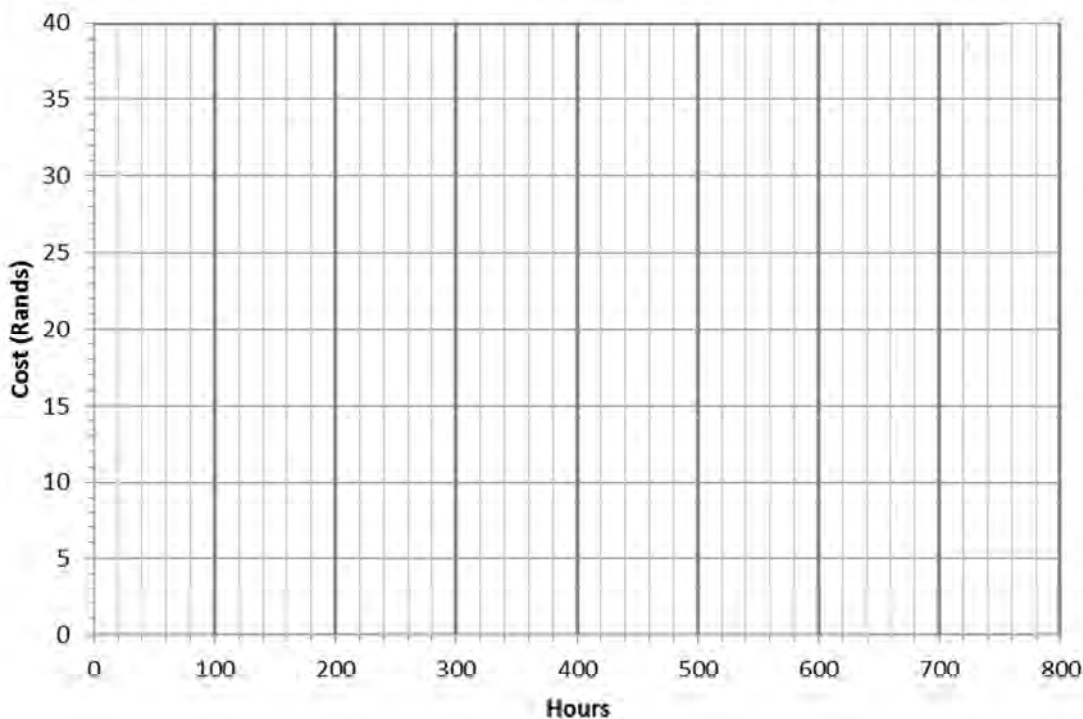

- 1.8 Using the graphs that you have drawn in question 1.7:

1.8.1 Explain the term 'break-even point'. (1)

1.8.2 Using the letter 'A' show where the break-even point occurs for the total costs of the two types of bulb and give the approximate values for cost and number of hours at that point. (3)

1.8.3 Using trial and error, calculate the number of hours for which the total cost for both bulbs is the same. (5)

[43]

## Question 2 – The picnic area

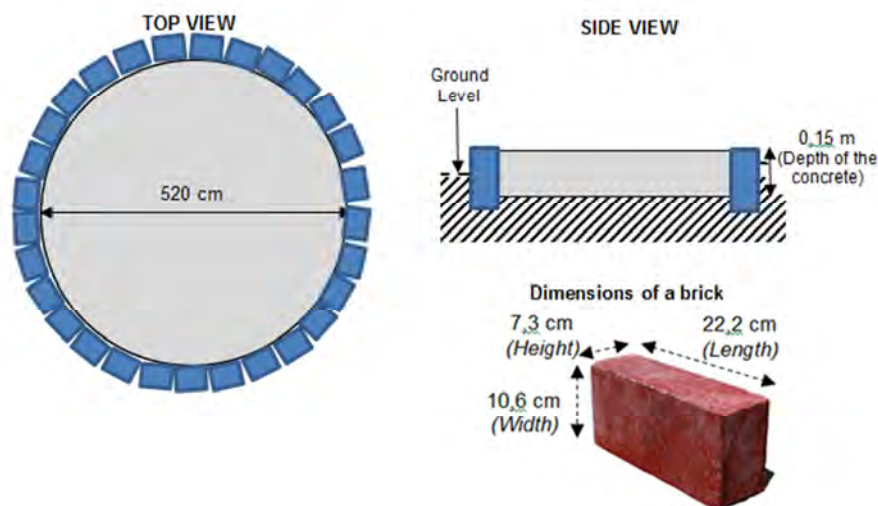

A circular concrete slab is planned for an outdoor picnic area. The circular concrete slab will be surrounded by bricks along the perimeter as follows: (NOTE: Drawings are NOT to scale)



- 2.1 Convert 520 cm to metres. (2)
- 2.2 Explain why we calculate the volume of the circular slab as a cylinder. (2)
- 2.3 Use the following equation to calculate the volume of the concrete in the circular concrete slab. Answer in  $\text{m}^3$ . ( $\pi = 3,142$ ) (4)

$$\text{Volume of cylinder} = \pi \times \text{radius}^2 \times \text{height}$$

- 2.4 In order to make concrete for a slab, the cement is mixed with sand and stone in the following ratio:

cement	concrete sand	stone
		
1 bag	$1\frac{1}{4}$ wheelbarrows	$1\frac{1}{4}$ wheelbarrows

- 2.4.1 1 bag of cement needs  $1\frac{1}{4}$  wheelbarrows of stone. Convert  $1\frac{1}{4}$  to a decimal. (1)
- 2.4.2  $1 \text{ m}^3$  of concrete needs 7,7 bags of cement. How many wheelbarrows of stone will be required to make  $1 \text{ m}^3$  of concrete? (Round the answer to the nearest  $\psi$  wheelbarrow). (3)

## Basic skills paper

2.4.3 Use your answers from questions 2.3 and 2.4.2 to calculate how many wheelbarrows of stone will be required to create the circular slab. (3)

2.5 Calculate the perimeter of the circular slab using the following equation. (Answer in cm.) (2)

$$\text{Perimeter of circle} = \pi \times \text{diameter}$$

2.6 The bricks are placed upright along the edge so that the width of the brick is laid along the perimeter of the circle.

2.6.1 Use the answer from question 2.5 to calculate the number of bricks that will be needed to fit along the edge of the circular slab. (4)

2.6.2 Each brick costs R2,40. How much more would it cost if the bricks are placed with their height along the edge of the perimeter? (6)

[27]

### Question 3 – Planning the layout of a room

Before moving to a new house, a family decides to plan the layout of furniture in their new house so that they can check whether all of their possessions will fit into the space. The rough drawing alongside was made of the lounge space which is an L-shape.

(NOTE: The drawing is NOT to scale)

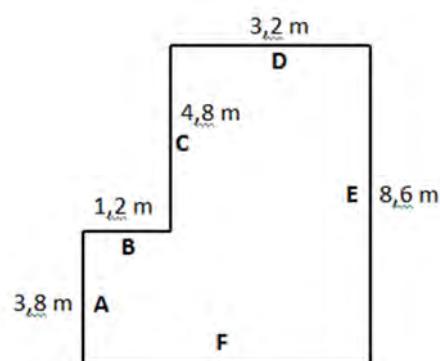

3.1 Calculate the missing measurement (marked F). (3)

3.2 In order to plan the layout, the family needs to draw a scale drawing of the lounge space. They have decided to use the scale of 1:80. Explain what a scale of 1:80 means. (2)

3.3 Using the measurements in the drawing, calculate the missing values in the table that follows (labelled 3.3.1 to 3.3.5) to 1 decimal place: (6)

## Basic skills paper

Wall	Measurement in real life (in cm)	Measurement on plan (in cm)
A	380	3.3.2
B	3.3.1	3.3.3
C	480	3.3.4
D	320	3.3.5

3.4 Using the values from the table, draw an accurate 1:80 scale drawing of the lounge. (3)

[14]

### Question 4 - Census 2011

Source: [www.statssa.gov.za](http://www.statssa.gov.za) ("The South Africa I know, The Home I Understand" booklet)

In 2011 South Africa took a census of its population. Here are some of the results:

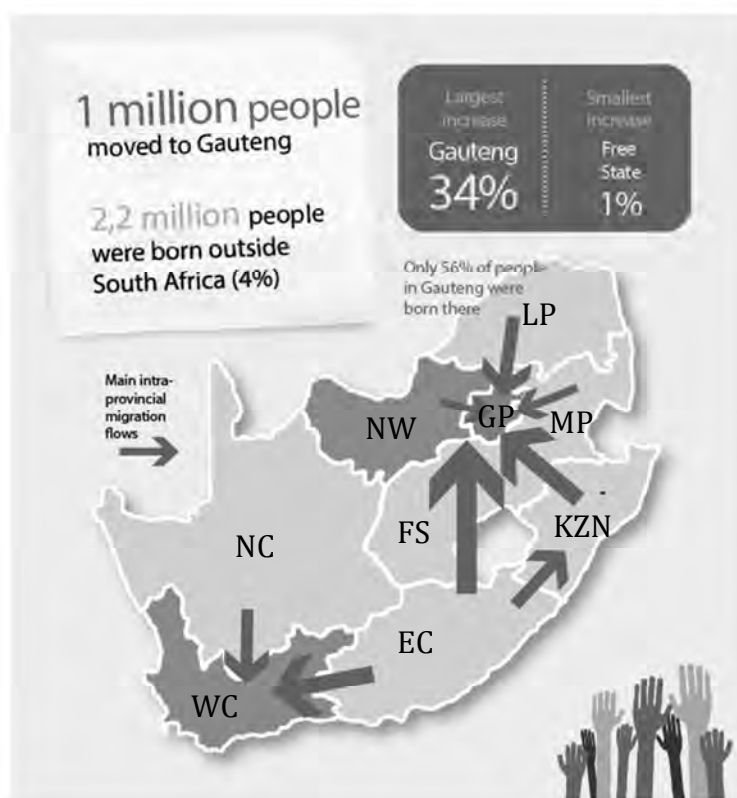

#### Key:

EC: Eastern Cape  
 FS: Free State  
 GP: Gauteng  
 KZN: KwaZulu Natal  
 LP: Limpopo  
 MP: Mpumalanga  
 NC: Northern Cape  
 NW: North West  
 WC: Western Cape

4.1 Explain what a census is. (2)

4.2 The arrows on the map above show the movement (migration) of people from one province in South Africa to another. The size of the arrow reflects the number of people moving to that province.

## Basic skills paper

- 4.2.1 Between which two provinces was the largest movement of people? (2)
- 4.2.2 Gauteng gained a lot of people from other provinces. Which province gained the second most people? Also state the provinces that these people came from. (3)
- 4.2.3 Gauteng now has 12 272 263 people in it. This represents 23,7% of South Africa's population. How many people live in South Africa? (Round your answer to the nearest thousand.) (3)
- 4.2.4 56% of Gauteng's current population were born there. How many people does this represent? (4)
- 4.2.5 Gauteng had the largest increase in population from the 2001 census when compared with all of the other provinces. Approximately how many people lived in Gauteng in 2001 if 12 272 263 live there now? (5)
- 4.3 The pictogram (a bar graph with pictures) below shows the average household income per racial group in South Africa.

- 4.3.1 How many times more does the average white household earn when compared to the average black African household? (2)

- 4.3.2 79,2% of the South African population is black African, while 8,9% of the South African population is white. Approximately how many black South Africans are there for every one white South African? (3)

- 4.3.3 Find the mean of the four average racial household incomes in the bar graph. (3)

- 4.3.4 Explain what an increase of 113% means. (2)

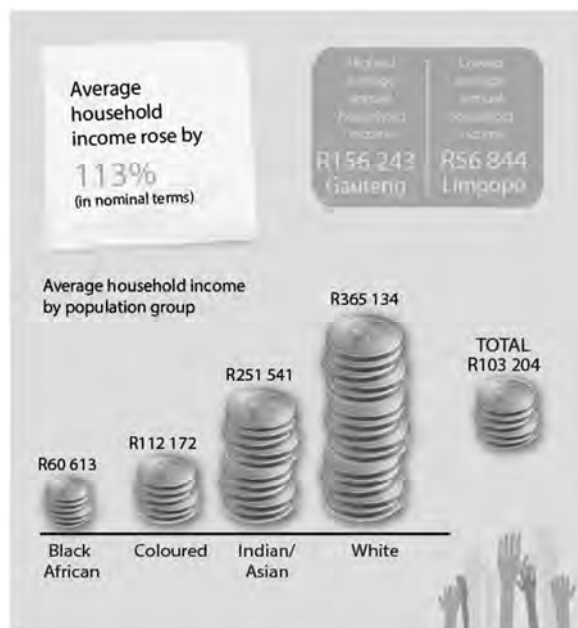

[29]

## Basic skills paper

## Question 5 – The tour company

Mfundo has a tour company. He picks up international tourists from OR Tambo airport and transports them to a private game reserve in Mozambique for some game viewing and relaxation.

- 5.1 In order to calculate his profit per trip, he draws up an income statement. It looks like this:

**Income Statement: 14 January trip**

<b>Total Income</b>		
Tourists (12 people @ R800 per person)		
<b>Total Expenditure</b>		
Fuel	R1 850,00	
Vehicle maintenance	R550,00	
Loan Repayment	R3 500,00	
Visa fees	R715,00	
Refreshments for the journey	R430,00	
<b>Profit:</b>		

- 5.1.1 Each person requires a visa (permission to enter a foreign country). How much did each visa cost if everyone on the bus needed a visa? (3)  
(Hint: the visa amount was a round number without cents).
- 5.1.2 Mfundo's vehicle uses 10,9 litres per 100 km travelled. Calculate how much fuel he will use to travel 543 km. (2)
- 5.1.3 Calculate his total expenditure for the journey. (2)
- 5.1.4 Calculate his total income per trip. (2)
- 5.1.5 Using your previous answers, calculate the profit that he made on this trip. (2)
- 5.1.6 Calculate the percentage profit that he made for this trip. (3)
- 5.2 When Mfundo was in Mozambique on his last trip, he needed some of the local currency to pay for a few things. He withdrew 20 000 Mozambique Metical (MT) from a bank ATM in Mozambique. The exchange rate was:

$$1 \text{ MT} = 0,301146 \text{ Rand}$$

## Basic skills paper

Calculate how much he withdrew in Rands. Round your answer to the nearest cent. (2)

5.3 One of his customers was from Germany and converted 300 Euros (€) to South African Rands at the airport.

5.3.1 Calculate the Rands he should have received when the exchange rate was: (2)

$$€ 1 = R0,084857$$

5.3.2 The exchange bureau charged a fee using the following formula:

$$\text{Service Fee} = R5,25 + 1,25\% \text{ of the Rand value}$$

Using your previous answer, calculate the fee that the German customer paid. (3)

5.3.3 This service fee was then taken off of the Rand value. Calculate the total Rands that the customer would have received. Round your answer down to the nearest Rand. (3)

5.4 One of the main reasons that the tourists come to this specific game reserve is the good game viewing. The reserve is divided into five camps that contain the following numbers of game:

	Blue Camp	Green Camp	Red Camp	Yellow Camp	Orange Camp
<b>Small animals (e.g. Meerkats)</b>	212	86	186	235	318
<b>Medium-sized animals (e.g. warthogs, buck)</b>	48	73	62	51	65
<b>Large animals (e.g. rhino, elephant)</b>	28	23	35	48	22

5.4.1 In which camp is a tourist most likely to see a large animal? Give a reason for your answer. (2)

5.4.2 An animal is seen in the Green camp. Calculate the probability that it is a small animal. Leave your answer as a fraction. (2)

5.4.3 There is a very high probability of seeing meerkats in the yellow camp. Does this mean that a visitor will definitely see meerkats on any given day? Explain (2)

## Basic skills paper

your answer.

- 5.4.4 There are 48 medium-sized animals in the Blue Camp and there are 48 large animals in the Yellow Camp. However the probability of seeing a medium-sized animal in the Blue Camp is higher than the probability of seeing a large animal in the Yellow Camp. Explain why. (2)
- 5.5 The manager of the game reserve would like to draw a pie chart to show the proportions of medium-sized animals in each camp. Explain the calculations that he would need to make. (3)
- 5.6 In the advertising brochure, the reserve would like to say: “The average number of large animals that can be seen in each camp is...”. Name TWO types of average that could be calculated in order to complete the sentence. (2)

[37]

**TOTAL: 150 Marks**



## Marking guidelines

### Paper 1: Marking guidelines

The following table shows the percentage of marks allocated to each of the levels of the taxonomy in this Paper 1 examination paper.

	Paper 1	
Taxonomy Level	% of paper	Required
Level 1 – Knowing	59%	60% ( $\pm 5\%$ )
Level 2 – Routine procedures	37%	35% ( $\pm 5\%$ )
Level 3 – Multi-step procedures	4%	5% ( $\pm 5\%$ )
Level 4 – Reasoning and reflecting	0	0% ( $\pm 5\%$ )

Question	Working	Taxonomy Level and Marks				Comment / analysis
		TL 1	TL 2	TL 3	TL 4	
1.1	10 000 hours <b>va</b>	1				<i>Finance: Tariff systems</i> Testing the ability to read data from a table
1.2	No. of days = 10 000 hours $\div$ 6 hours/day <b>vm</b> = 166,67 days <b>vca</b> 167 days <b>vca</b>	3				<i>Measurement: Time</i> Testing an understanding of rate
1.3	Incandescent (regular) bulb <b>va</b>	1				<i>Finance: tariff systems</i> Testing ability to compare relevant data
1.4.1	60 W $\div$ 1 000 <b>vm</b> = 0,06 kW <b>va</b>	2				<i>Measurement: Conversions</i> Testing an understanding that 'kilo' means 1000 units.
1.4.2	Total hours = 6 hours/day $\times$ 7 days = 42 hours <b>vm</b> Units of electricity = kiloWatts $\times$ hours = 0,015 kW $\times$ 42 hours <b>vm</b> = 0,63 kWh <b>va</b>	3				<i>Measurement: Time</i> Testing a time-based calculation which depends on a rigid application of BODMAS principles and an awareness of units

## Marking guidelines

Question	Working	Taxonomy Level and Marks				Comment / analysis
		TL 1	TL 2	TL 3	TL 4	
1.4.3	Units of electricity per hour = 0,015 kW x 1 hr <b>vm</b> = 0,015 kWh <b>va</b> No. of hours = 1 units ÷ 0.015 <b>vm</b> units / hour = 66,67 hours <b>vca</b> 67 hours <b>vca</b>		5			<i>Measurement: time</i> Testing calculate a Net Salary.
1.5.1	Hours. <b>va</b> This is because the total cost is dependent on the number of hours. <b>va</b>	2				<i>Finance: Tariff systems</i> Testing the basic skill of identifying the independent variable in a given situation.
1.5.2	This is the cost of a bulb <b>va</b>	1				<i>Finance: Tariff systems</i> Testing the awareness of where parts of an equation come from.
1.5.3	The power rating of the fluorescent bulb is a quarter of the power rating for the incandescent <b>va</b>	1				<i>Finance: Tariff Systems</i> Testing an awareness of the role of rate in an equation
1.6.1	Total Cost = R0,036 x 250 hours <b>vm</b> + R10 = R9 + R10 <b>vm</b> = R19,00 <b>vca</b>		3			<i>Finance: Break-even Analysis</i> Testing the ability to substitute a value into an equation and perform basic operations in order to determine the dependent variable.
1.6.2	Total Cost = R0,009 x 350 hours <b>vm</b> + R19,99 <b>vm</b> = R23,14 <b>vca</b>		3			<i>Finance: Break-even Analysis</i> Testing the ability to substitute a value into an equation and perform basic operations in order to determine the dependent variable.
1.6.3	Could use either equation. Using Incandescent equation: Total Cost = R0,036 x hours + R10,00 R35,92 <b>vm</b> = R0,036 x hours + R10,00 R25,92 = R0,036 x hours (Subtr R10,00) <b>vm</b>		3			<i>Finance: Break-even Analysis</i> Testing the ability to substitute correctly into an equation and perform basic operations in order to solve for the independent variable

## Marking guidelines

Question	Working	Taxonomy Level and Marks				Comment / analysis
		TL 1	TL 2	TL 3	TL 4	
	720 = No. of hours <b>Vca</b>					
1.7						
	<p><b>Va</b> Appropriate title for graphs</p> <p><b>Va:</b> Incandescent points plotted correctly</p> <p><b>Va</b> Flourescent points plotted correctly</p> <p><b>Va</b> incand. Straight line plotted to y-int.</p> <p><b>Va</b> fluor. Straight line plotted to y-int.</p> <p><b>Va:</b> Key or graphs labelled</p>		6			<p><i>Finance: Break-even Analysis</i></p> <p>Testing the ability to construct appropriate graphs from given values.</p>
1.8.1	The point at which both costs (or cost and income in some cases) are the same. <b>Va</b>	1				<p><i>Finance: Break-even Analysis</i></p> <p>Testing the knowledge of break-even point</p>
1.8.2	<p>Crossing point of the two graphs marked with an A. <b>Va</b> Approximate values indicated. Should be fairly close to (370 hours; R23,32)</p> <p><b>Va (Accept 360 – 380 hrs)</b></p> <p><b>Va (Accept R23 – R24)</b></p>		3			<p><i>Finance: Break-even Analysis</i></p> <p>Testing the knowledge of break-even point</p>

## Marking guidelines

Question	Working	Taxonomy Level and Marks				Comment / analysis
		TL 1	TL 2	TL 3	TL 4	
1.8.3	<p>Example:</p> <p>Flouresc: Total Cost = <math>0,009 \times 360 + R19,99 = R23,23</math></p> <p>Incandesc: Total Cost = <math>0,036 \times 360 + R10,00 = R22,96</math></p> <p>Not the same, therefore try another value:</p> <p>Substitute in 365 hours...</p> <p>Until 370 hours</p> <p>NOTE: If 370 hours correctly substituted as the first value, then 5 marks awarded if comment is made about the values being the same.</p> <p>Marking:</p> <p><b>vm</b>: substitute a value into incandescent equation</p> <p><b>vm</b>: substitute <i>the same value</i> into the flourescent equation</p> <p><b>vm</b>: comment on how close the values are.</p> <p><b>vm</b>: substitute another value into both equations.</p> <p><b>va</b>: Final answer as 370 hours</p>		5			<p><i>Finance: Break-even Analysis</i></p> <p>Testing the basic skill of solving simultaneous equations by trial and error.</p>
2.1	<p><math>520 \text{ cm} \div 100</math> <b>vm</b> = 5,2 m<b>va</b></p>	2				<p><i>Measurement: Conversions</i></p> <p>Testing the ability to correctly convert in the metric system.</p>
2.2	<p>The shape has a circle on both ends <b>va</b> and it has straight sides between those ends. <b>vca</b></p>	2				<p><i>Measurement: Measuring Volume</i></p> <p>Testing the understanding of how to calculate the volume of a cylinder</p>
2.3	<p><math>\text{Vol} = 3,142 \times (2,6 \text{ m<b>va</b>)}^2 \times 0,15 \text{ m}</math></p> <p><b>vm</b> = <math>3,142 \times (6,76 \text{ m}^2) \text{ <b>vm</b> } \times 0,15 \text{ m}</math></p> <p>= <math>3,19 \text{ m}^3</math><b>vca</b></p>		4			<p><i>Measurement: Measuring Volume</i></p> <p>Testing the ability to use a given formula to substitute correctly</p>

## Marking guidelines

Question	Working	Taxonomy Level and Marks				Comment / analysis
		TL 1	TL 2	TL 3	TL 4	
						and calculate the volume of a cylinder
2.4.1	1,25 <b>Va</b>	1				<i>Basic Skills: Number formats and conventions</i> Testing the skill of converting between different number formats
2.4.2	7,7 x 1,25 <b>VVm</b> = 9,625 wheelbarrows <b>Vca</b> » 9,5 wheelbarrows <b>Va</b>	3				<i>Basic Skills: Ratio</i> Testing the ability to use given mixing ratios to determine the quantities
2.4.3	3,19 m <sup>3</sup> x <b>Vm</b> 9,5 wheelbarrows <b>Vca</b> = 30,4 wheelbarrows. <b>Vca</b>	3				<i>Measurement: Measuring Volume</i> Testing the ability to use given information to determine necessary quantities
2.5	Perimeter = 3,142 x 520 cm <b>Va</b> = 1 633,84 cm <b>Vca</b>	2				<i>Measurement: Measuring Length</i> Testing the ability to use a given formula to determine a perimeter
2.6.1	No. of bricks = 1 633,84 cm ÷ <b>Vm</b> 10,6 cm <b>Va</b> = 154,13 bricks <b>Vca</b> » 154 bricks <b>Vca</b>		4			<i>Measurement: Measuring Length</i> Testing the ability to use a perimeter to determine the quantity of an item to go around it.
2.6.2	No. of bricks = 1 633,84 cm ÷ 7,3 cm <b>Vm</b> = 223,81 bricks <b>Vca</b> 223 bricks <b>Vca</b> No. of extra bricks = 223 - 154 = 69 bricks <b>Vca</b> Total extra cost = R2,40 x 69 <b>Vm</b> = R165,60 <b>Vca</b>			6		<i>Measurement: Measuring Length</i> Testing the ability to use a perimeter to determine the quantity of an item to go around it and compare it to a previously calculated value.
3.1	3,2 m <b>Va (values)</b> + <b>Vm</b> 1,2 m = 4,4 m. <b>Va(units)</b>	3				<i>Maps, plans, etc: Plans</i> Testing the ability to interpret a

## Marking guidelines

Question	Working	Taxonomy Level and Marks				Comment / analysis
		TL 1	TL 2	TL 3	TL 4	
						plan and identify how parts of it are constructed.
3.2	A scale of 1:80 means that 1 cm (or other unit) on the drawing (or map) <b>Va</b> represents 80 cm in real life. <b>Va</b>	2				<i>Maps, plans, etc: Scale</i> Testing an understanding of the concept of scale.
3.3.1	120 <b>Va</b>	1				<i>Maps, plans, etc: Scale</i> Testing the ability to interpret a plan, identify a part of it and convert it to an appropriate unit.
3.3.2	380 cm ÷ 80 <b>Vm</b> = 4,8 cm <b>Vca</b>	2				<i>Maps, plans, etc: Scale</i> Testing the skill of using a given scale to convert from real life to plan measurements.
3.3.3	120 cm ÷ 80 <b>Vca</b>	1				<i>Maps, plans, etc: Scale</i> Testing the skill of using a given scale to convert from real life to plan measurements.
3.3.4	480 cm ÷ 80 = 6,0 cm <b>Va</b>	1				<i>Maps, plans, etc: Scale</i> Testing the skill of using a given scale to convert from real life to plan measurements.
3.3.5	320 cm ÷ 80 = 4,0 cm <b>Va</b>	1				<i>Maps, plans, etc: Scale</i> Testing the skill of using a given scale to convert from real life to plan measurements.

## Marking guidelines

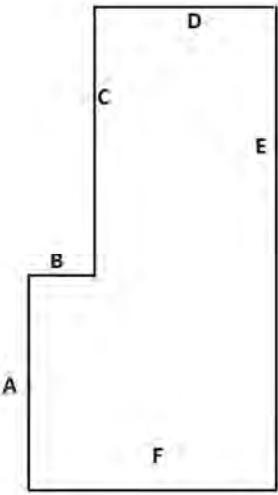
Question	Working	Taxonomy Level and Marks				Comment / analysis												
		TL 1	TL 2	TL 3	TL 4													
3.4	 <p><b>Va:</b> At least 3 lengths drawn correctly (according to values in previous question)</p> <p><b>Va:</b> all values correctly drawn</p> <p><b>Va:</b> Drawing neatly drawn</p>		3			<p><i>Maps, plans, etc: Plans</i></p> <p>Testing the skill of using calculated measurements to create an accurately drawn scale plan.</p>												
4.1	It is a large survey <b>Va</b> of the whole population of a country <b>Va</b> .	2				<p><i>Data Handling: Collecting Data</i></p> <p>Testing knowledge of an important term.</p>												
4.2.1	EC <b>Va</b> & GP <b>Va</b>	2				<p><i>Data Handling: Representing Data</i></p> <p>Testing ability to interpret a representation of data.</p>												
4.2.2	WC <b>Va</b> gained the second most From EC <b>Va</b> & NC <b>Va</b>	3				<p><i>Data Handling: Representing Data</i></p> <p>Testing ability to interpret a representation of data.</p>												
4.2.3	<table border="0"> <tr> <td><b>People</b></td> <td><b>%</b></td> <td></td> </tr> <tr> <td>12 272 263</td> <td>:</td> <td>23,7<b>Vm</b></td> </tr> <tr> <td>51 781 700<b>Va</b></td> <td>:</td> <td>100</td> </tr> <tr> <td>Approx 51 782 000<b>Vca</b></td> <td></td> <td></td> </tr> </table>	<b>People</b>	<b>%</b>		12 272 263	:	23,7 <b>Vm</b>	51 781 700 <b>Va</b>	:	100	Approx 51 782 000 <b>Vca</b>			3				<p><i>Basic Skills: Percentage</i></p> <p>Testing ability to correctly understand and perform calculations involving percentage.</p>
<b>People</b>	<b>%</b>																	
12 272 263	:	23,7 <b>Vm</b>																
51 781 700 <b>Va</b>	:	100																
Approx 51 782 000 <b>Vca</b>																		

## Marking guidelines

Question	Working	Taxonomy Level and Marks				Comment / analysis
		TL 1	TL 2	TL 3	TL 4	
4.2.4	56% of $\text{Vm}$ 12 272 263 $\text{Va}$ = 6 872 467,28 $\text{Vca}$ » 6 872 467 $\text{Vca}$	4				<i>Basic Skills: Percentage</i> Testing ability to correctly understand and perform calculations involving percentage.
4.2.5	<b>People</b> % 12 272 263 : 134 $\text{Vva}$ 9 158 405,2 $\text{Vca}$ : 100 $\text{Vm}$ Approx 9 158 405 $\text{Vca}$		5			<i>Basic Skills: Percentage</i> Testing ability to correctly understand and perform calculations involving percentage.
4.3.1	$R365\,134 \div R60\,613$ $\text{Va}$ (values) = 6,02 times more	2				<i>Basic Skills: Operations on numbers</i> Testing ability to perform basic calculations.
4.3.2	$79,2\% \div \text{Vm}$ 8,9% = 8,88 $\text{Vca} \approx$ 9 $\text{Vca}$	3				<i>Basic Skills: Operations on numbers</i> Testing ability to perform basic calculations.
4.3.3	Mean = $\text{sum} \div 4$ $\text{Vm}$ = 789 460 $\text{Va} \div 4$ = 197 365 $\text{Vca}$		3			<i>Data Handling: Summarising Data</i> Testing ability to perform basic data summary calculations.
4.3.4	The original amount was multiplied by 113%. $\text{Va}$ This increase would then be added onto the original amount to give a new amount that was 2,13 $\text{Va}$ times the original amount (100% + 113%)	2				<i>Basic Skills: Percentage</i> Testing ability to correctly understand and perform calculations involving percentage.
5.1.1	Total people = $12 + 1 = 13$ Visa cost = R715,00 13 $\text{Vm} =$ R55 $\text{Va}$		3			<i>Finance: Income and expenditure statement</i> Testing ability to perform basic calculations using values gained from an income and expenditure statement



## Marking guidelines

Question	Working	Taxonomy Level and Marks				Comment / analysis
		TL 1	TL 2	TL 3	TL 4	
5.1.2	Fuel = $543\ 100 \times 10,9$ <b>Vm</b> = 59,19 <b>Va</b>	2				<i>Maps, plans, etc: Maps</i> Testing the ability to perform calculations in order to plan for a trip.
5.1.3	$R1\ 850 + R550 + R3\ 500 + R715 + R430$ <b>Vm</b> = R7 045 <b>Va</b>	2				<i>Finance: Income and expenditure statement</i> Testing ability to perform basic calculations using values gained from an income and expenditure statement
5.1.4	$12 \times R800,00$ <b>Vm</b> = R9 600,00 <b>Va</b>	2				<i>Finance: Income and expenditure statement</i> Testing ability to perform basic calculations using values gained from an income and expenditure statement
5.1.5	Profit = $R9\ 600 - R7\ 045$ <b>Vm</b> = R2 555,00 <b>Va</b>	2				<i>Finance: Income and expenditure statement</i> Testing ability to perform basic calculations using values gained from an income and expenditure statement
5.1.6	% Profit = $\frac{\text{Profit}}{\text{Expenditure}} \times 100$ = $\frac{R2\ 555,00}{R7\ 045}$ <b>Va</b> $\times 100$ = 36,27% <b>Vca</b>		3			<i>Finance: Income and expenditure statement</i> Testing ability to perform basic calculations using values gained from an income and expenditure statement
5.2	Rand = $20\ 000\text{MT} \times R0,301146$ <b>Vm</b> = R6 022,92 <b>Va</b>	2				<i>Finance: Exchange Rates</i> Testing ability to perform basic exchange rate calculations
5.3.1	Rand = $300 \div 0,084857$ <b>Vm</b> = R3 535,36 <b>Va (rounded to cents)</b>	2				<i>Finance: Exchange Rates</i> Testing ability to perform basic exchange rate calculations

## Marking guidelines

Question	Working	Taxonomy Level and Marks				Comment / analysis
		TL 1	TL 2	TL 3	TL 4	
5.3.2	Service Fee = R5,25 + 1,25% of R3 535,36 <b>Vm</b> $= R5,25 + 0,0125 \times R3\ 535,36$ $= R5,25 + R44,19$ $= R49,43$ <b>Vca</b>		3			<i>Finance: Exchange Rates</i> Testing ability to calculate the commission charged by an institution for exchange rate transactions.
5.3.3	Total received = R3 535,36 - <b>Vm</b> R49,43 $= R3\ 485,93$ <b>Vca</b> R3 485 <b>Vca</b>	3				<i>Finance: Exchange Rates</i> Testing ability to calculate the commission charged by an institution for exchange rate transactions.
5.4.1	Yellow Camp. <b>Va</b> There are more of them there. <b>Va</b>	2				<i>Probability: Prediction</i> Testing ability to use basic principles to make a prediction
5.4.2	Total animals in green camp = 162 <b>Va</b> Probability = $86 \div 162$ <b>Va</b>	2				<i>Probability: Prediction</i> Testing ability to perform basic probability calculations
5.4.3	No. <b>Va</b> Probability is an indication of likelihood and not a guarantee. <b>Va</b>	2				<i>Probability: Prediction</i> Testing the basic knowledge of probability
5.4.4	There are more animals <b>Va</b> in the yellow camp, so the denominator will be larger which will lower the probability <b>Va</b>	2				<i>Probability: Prediction</i> Testing the basic knowledge of probability
5.5	He would need to total all of the medium-sized buck in the reserve (299). <b>Va</b> Then for each camp he would divide the number of buck in that camp <b>Va</b> by the total buck and then multiply by 360 degrees. <b>Va</b>	3				<i>Data Handling: Representing Data</i> Testing the basic knowledge of pie charts
5.6	Mean <b>Va</b> or median <b>Va</b>	2				<i>Data Handling: Summarising Data</i> Testing the basic knowledge of ways of summarising data
	<b>Total (%)</b>	<b>59</b>	<b>37</b>	<b>4</b>	<b>0</b>	

## Grade 11 Mathematical Literacy

## Paper 2

## (Applications paper)

150 Marks

3 Hours

Read these instructions carefully.

- Answer all the questions.
- It is advisable to show all working and to work neatly.
- You may use a calculator.
- Drawings are NOT to scale (unless otherwise stated).

**Question 1 – Money matters**

The South African income tax system has been designed in such a way that an individual pays income tax in proportion to what they earn. Use the following tables to answer the questions below:

TAX RATES		INDIVIDUALS – 2010	
Tax Bracket	Taxable annual income	Rates of tax	
1	R 0 - R132 000	18% of each R1	
2	R132 001 - R210 000	R 23 760 + 25% of the amount over R132 000	
3	R210 001 - R290 000	R 43 260 + 30% of the amount over R210 000	
4	R290 001 - R410 000	R 67 260 + 35% of the amount over R290 000	
5	R410 001 - R525 000	R109 260 + 38% of the amount over R410 000	
6	R525 001 +	R152 960 + 40% of the amount over R525 000	
TAX RATES		INDIVIDUALS – 2011	
Tax Bracket	Taxable annual income	Rates of tax	
1	R 0 - R140 000	18% of the R1	
2	R140 001 - R221 000	R 25 200 + 25% of the amount over R140 000	
3	R221 001 - R305 000	R 45 450 + 30% of the amount over R221 000	
4	R305 001 - R431 000	R 70 650 + 35% of the amount over R305 000	
5	R431 001 - R552 000	R114 750 + 38% of the amount over R431 000	
6	R552 001 +	R160 730 + 40% of the amount over R552 000	
TAX THRESHOLDS			
		Taxable income	
		2010	2011
Persons under 65		R54 200	R57 000
Persons over 65		R84 200	R88 528
TAX REBATES			
		2010	2011
Amount deductible from the tax payable			
Persons under 65		R9 756	R10 260
Persons over 65		R15 156	R15 935
These rebates are not available to either normal or special trusts, and companies.			

## Applications paper

- 1.1 The value of the tax rebate increased from 2010 to 2011. Calculate the increase in the tax rebate for a person under the age of 65. (2)
- 1.2 What is the maximum amount that a person would need to earn in 2010 before they started to pay income tax? (1)
- 1.3 Why do you think that the levels of income in each tax bracket were increased from 2010 to 2011? Give TWO reasons. (2)
- 1.4 Geoffrey, aged 35, earned a taxable income of R16 350,00 per month in 2010.
- 1.4.1 Which tax bracket would he have fallen into in 2010? Show your working. (3)
- 1.4.2 Which tax bracket would he have fallen into in 2011? (1)
- 1.5 Calculate how much income tax Geoffrey had to pay in the year 2010. (6)
- 1.6 Using the answer to Question 1.5, calculate his net monthly salary (the monthly amount that he would receive after tax). (3)
- 1.7 The company Geoffrey works for awarded no salary increases for 2011 due to the economic recession. If Geoffrey continues to earn the same monthly salary as he did in 2010, his annual tax is calculated to be R34 315,00. By what percentage has his tax decreased in 2011? (3)
- 1.8 Geoffrey works as a consultant for an internet research company. The following information was obtained by Census 2011:

Internet access	Population group of the household head					Total
	Black African	Coloured	Indian or Asian	White	Other	
From home	443 447	90 884	78 623	615 560	10 672	1 239 187
From cell phone	1 865 153	184 025	69 076	224 222	14 440	2 356 916
From work	334 095	57 221	40 848	242 088	3 989	678 242
From elsewhere	699 696	44 734	13 877	48 609	4 379	811 295
No access to internet	8 018 179	679 211	144 783	476 152	46 169	9 364 494
<b>Total</b>	<b>11 360 570</b>	<b>1 056 076</b>	<b>347 208</b>	<b>1 606 631</b>	<b>79 648</b>	<b>14 450 133</b>

- 1.8.1 How many Indian/Asian people who were surveyed accessed the internet in some way or another? (2)
- 1.8.2 Calculate the probability that an Indian/Asian person who did access the internet did so from work. Answer as a percentage. (3)

1.8.3 Is it more likely that a Coloured person will access the internet from a cell phone or that a White person will access the internet from a cell phone? Show calculations to prove your answer. (6)

1.9 The pie graph alongside shows how people in South Africa access the internet (from Census 2011). Refer to it and the table above to answer the following questions:

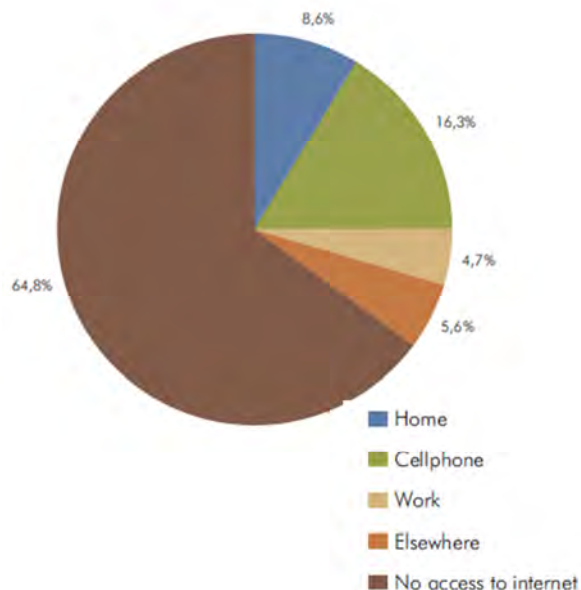

1.9.1 Is it more likely or less likely that the 'from home' category will grow? Give a reason for your answer. (2)

1.9.2 What delivery method should an internet company be focusing on in order to reach the large number of people who do not currently access the internet? Give a reason for your answer. (2)

[36]

## Question 2 – Investments

Sara wants to buy a house. She finds a suitable house for R1 200 000. Sara will have to take out a home loan to buy the house.

2.1 Use the factor table and formula given below it to calculate the monthly repayments on her home loan. She will repay the loan over 20 years. She will be charged an interest rate of 9,5%. (3)

FACTOR TABLE										
Loan Period	Interest Rate									
	8,0%	8,5%	9,0%	9,5%	10,0%	10,5%	11,0%	11,5%	12,0%	12,5%
15 yrs	9.56	9.85	10.14	10.44	10.75	11.05	11.37	11.68	12.00	12.33
20 yrs	8.36	8.68	9.00	9.32	9.65	9.98	10.32	10.66	11.01	11.36
25 yrs	7.72	8.05	8.39	8.74	9.09	9.44	9.80	10.16	10.53	10.90
30 yrs	7.34	7.69	8.05	8.41	8.78	9.15	9.52	9.90	10.29	10.67

## Applications paper

$$\text{Monthly repayment} = (\text{loan amount} \div 1000) \times \text{factor}$$

- 2.2 Banks insist that a monthly repayment must not exceed 30% of a person's income (after tax). According to Census 2011, the average household income for Gauteng was R156 222 per year.

Would the average person in Gauteng be able to afford a house valued at R500 000 if they were able to obtain a loan at 9,0% over 30 years? (6)

- 2.3 Sara however, is very tempted to buy the car of her dreams instead of a house. She fancies a top-of-the-range SUV costing R1 200 000, the same amount as her desired house. In order to make up her mind she studies the graph below showing the annual rate of depreciation of the value of a car during its first three years of ownership and the inflation in the value of a house for the past three years. Use it to answer the questions that follow:

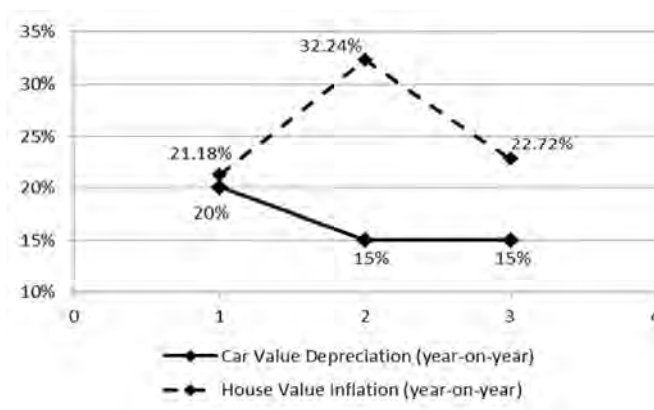

- 1.3.1 Referring to the above graph, explain why the following statements are false.

- a. The value of the car decreases until year 2 and then remains the same for years 2 to 3. (2)
- b. The value of the house increases for 2 years and then decreases in the last year. (2)
- c. In year 2, the value of the car and the house are different by 17,24%. (2)

- 2.3.2 If Sara had bought the house 3 years ago for the current price, how much would it be worth now? Show all working. (6)

- 2.3.3 Without any further calculations, but using the graph above, do you think that buying a house or buying a vehicle would have been a better investment? Give full reasons for your answer. (3)

[24]

## Applications paper

## Question 3: Car port

A man wants to build a car port to protect his cars from the rain and sun. Three of the sides are built of brick and the front is open. The roof is covered with metal roof sheeting. The drawing on the left is the rough plan and is NOT to scale, while the drawing on the right is the right side view

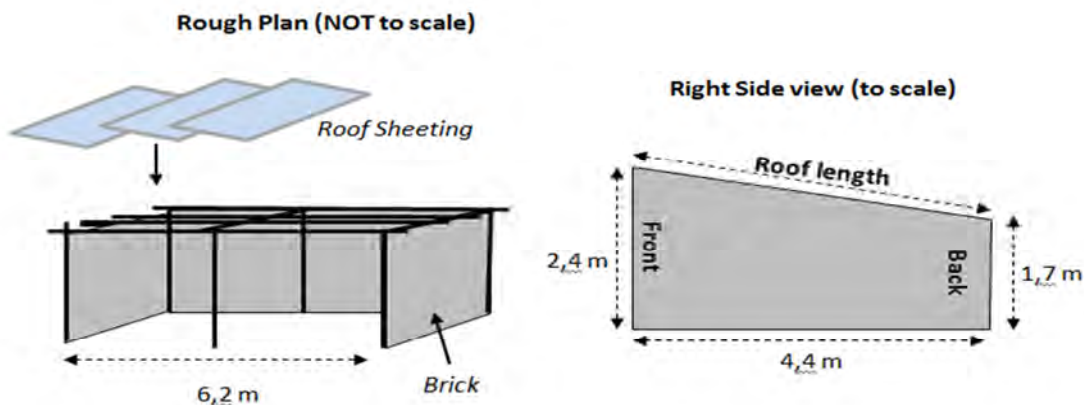

- 3.1 State the dimensions of the rear wall of the car port. (2)
- 3.2 The view of the right side of the car port is to scale. Calculate the scale of the view in the form 1 : ... (5)
- 3.3 Using the scale that you calculated in Question 3.2 (or any other method), calculate the roof length (shown on the right side view). Answer in metres. (3)
- 3.4 Calculate the area of the side wall using the formulas below. Answer in  $\text{m}^2$ . (5)

$$\text{Area of Rectangle} = \text{Length} \times \text{Breadth}$$

$$\text{Area of Triangle} = \frac{1}{2} \times \text{Base} \times \text{Height}$$

- 3.5 The bricks that will be used in the walls will be grey cement blocks which measure 190 mm by 400 mm and which will be surrounded by 12 mm of mortar around each brick.

- 3.5.1 Each brick makes  $0,083224 \text{ m}^2$  of wall area when it is part of the wall. Show how this was calculated. (3)

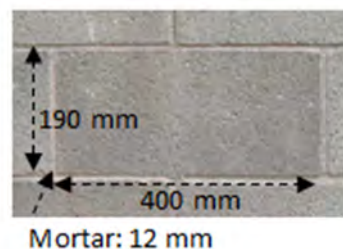

- 3.5.2. Using the value from Question 3.5.1 and your answer from Question 3.4, calculate the approximate number of bricks that will be required to build the side wall. (4)
- 3.5.3 Why is the answer to question 3.5.2 only *approximate*? (2)

## Applications paper

- 3.6 The roof sheeting consists of corrugated metal where each sheet overlaps the one next to it. Each sheet is 737 mm wide, but can only cover 665 mm. Refer to the diagram below and explain why each sheet covers less than its actual width:

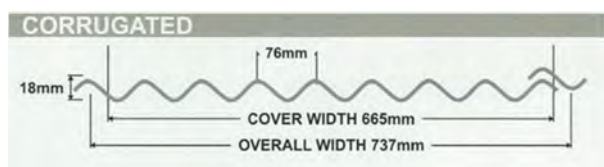

- 3.7 Using the cover width, how many sheets will be required to fit along the top of the car port?

(2)

(4)

[30]

### Question 4 – Weights and heights

A group of 16-year old boys measured their weights and their heights.

Here are their height measurements:

170 cm 175 cm 172 cm 185 cm 171 cm 174 cm  
175 cm 169 cm 171 cm 172 cm 170 cm 170 cm

- 4.1 Find the mean of heights (3)
- 4.2 Find the median of data. Show all working. (3)
- 4.3 Which will be the more accurate measurement of the 'average' in this case? Give a reason for your answer. (2)
- 4.4 Why would the 'average' of the above data be considered to be meaningless if the group consisted of eight 16-year old girls and eight 16-year old boys instead? (2)

The weights of the same boys were as follows (not in the same order as their heights):

52 kg 56 kg 58 kg 61 kg 62 kg 62 kg 64 kg 65 kg 69 kg 72 kg 73 kg 80 kg

- 4.5 Calculate the quartile 2 for the above weights. Show all working. (2)
- 4.6 Calculate the first and third quartiles for the weight data. (3)



## Applications paper

- 4.7 The following is a box and whisker plot which represents the weights of all 16-year old boys in a local school. Use it to answer the questions that follow:

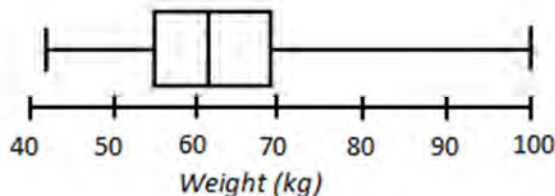

- 4.7.1 The 'whisker' on the right of the above plot is very long. What does this indicate? (2)
- 4.7.2 Use the above box-and-whisker plot to determine the first, second and third quartiles for the weights of all 16-year old boys in the school. (3)
- 4.7.3 Referring to the data in the box-and-whisker plot, is the group of boys heavier overall than the 16-year old boys in the school? Give full reasoning for your answer comparing values from the previous questions and commenting on how spread out the data is. (4)
- 4.8 A 15-year old boy realises that his height in centimetres is the same as his weight in pounds. He weighs 169 pounds and is 169 cm in height.
- 4.8.1 His height is in the 40th percentile of heights for all 15-year old boys. Does this mean that he is taller or shorter than the average height for a 15-year old boy? Give a reason for your answer. (2)
- 4.8.2 His weight is in the 93rd percentile. Use your previous answer to state whether he has a healthy weight for his height. Give full reasoning. (3)
- 4.8.3 You should already be familiar with the following BMI equation:

$$\text{BMI} = \frac{\text{Weight (in kg)}}{(\text{Height (in m)})^2}$$

- Use it to calculate the BMI for the 15-year old. (Note that 1 kg = 2,2 pounds) (5)

Applications paper

4.8.4 Using the table and graph below, comment on the weight status of the 15-year old boy. (3)

Weight status classifications	
Weight status	Percentile range position on the growth chart
Underweight	Less than the 5th percentile
Healthy weight	≥ 5th percentile and < 85th percentile
At risk of overweight	≥ 85th percentile and < 95th percentile
Overweight	≥ 95th percentile

2 to 20 years: Boys

NAME \_\_\_\_\_

Body mass index-for-age percentiles

RECORD # \_\_\_\_\_

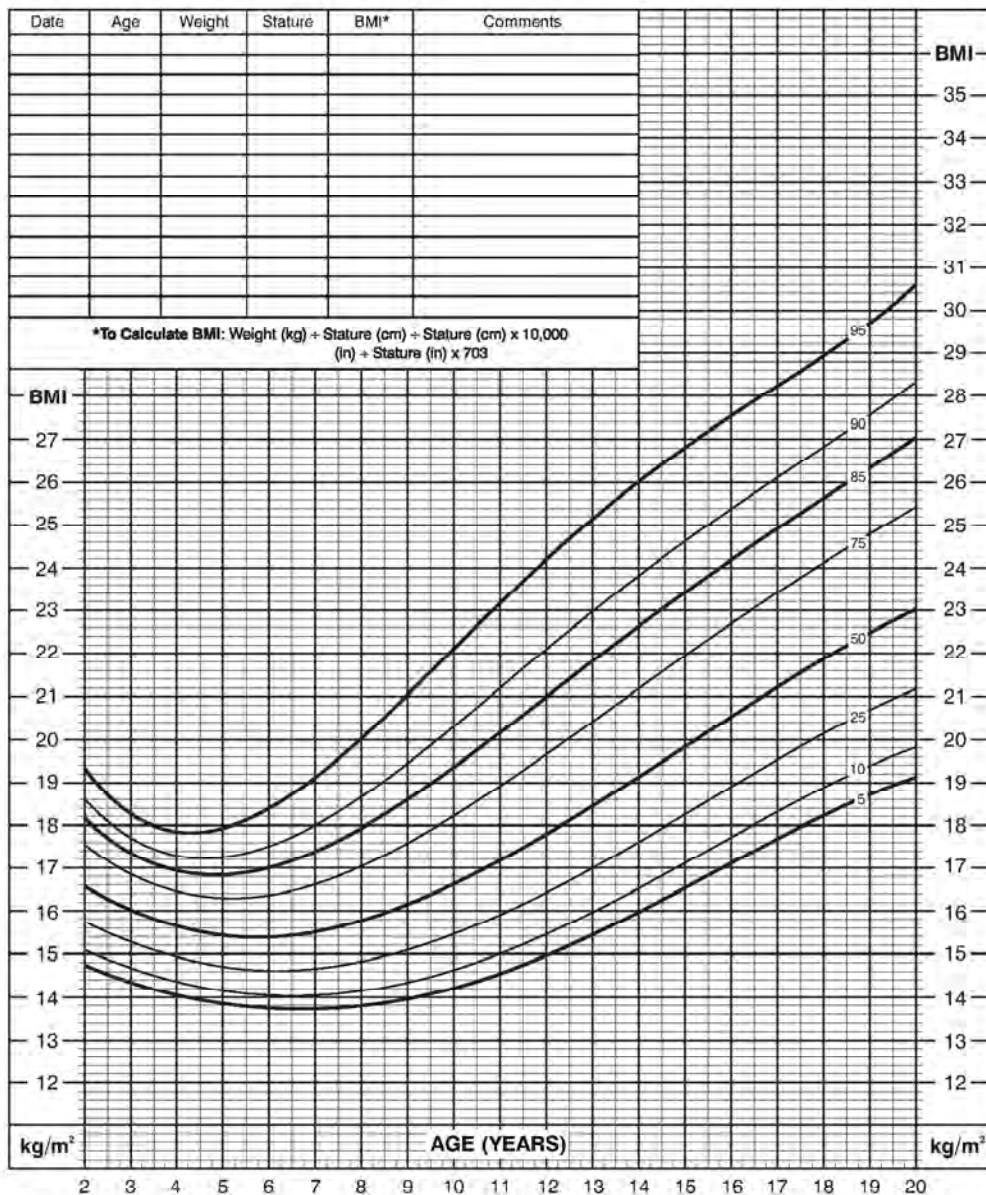

4.8.5 If the 15-year old boy maintains the same BMI until he is 20 years old, what will his weight status be then? (2)

[39]

## Applications paper

**Question 5 – By plane or road?**

Mr Dhlamini, his wife and their two children are planning a holiday in Cape Town. They live in Pietermaritzburg. Mr Dhlamini is trying to decide whether to travel by plane or by car.

- 5.1 The nearest major airport is in Durban. Mr Dhlamini looks online and finds the following fares:

(6)

Depart: DUR Durban to CPT Cape Town on 31 January 2013

Outbound fares shown require round-trip purchase.

Sector	Flight	Departs	Arrives	ECONOMY	
				SAVER	PLUS
Durban (DUR) - Cape Town (CPT)	SA 1850	08:10	08:25	Sold Out	Sold Out
Durban (DUR) - Cape Town (CPT)	SA 7967	07:45	10:00	ZAR 3808	ZAR 4457
Durban (DUR) - Cape Town (CPT)	SA 7969	12:10	14:25	Sold Out	ZAR 4457
Durban (DUR) - Cape Town (CPT)	SA 7981	14:05	16:25	ZAR 3808	ZAR 4457
Durban (DUR) - Cape Town (CPT)	SA 1858	15:35	17:40	Sold Out	Sold Out
Durban (DUR) - Cape Town (CPT)	SA 7973	17:00	19:15	ZAR 3808	ZAR 4457
Durban (DUR) - Cape Town (CPT)	SA 7983	19:30	21:50	ZAR 3808	ZAR 4457

When considering which flight to book, Mr Dhlamini has to keep the following in mind:

- His children are very young and so he cannot arrive in Cape Town after 6:30 pm.
- The taxi can only pick them up to take them to the airport from 5:45 am onwards.
- The journey to the airport takes 1 hour and 20 minutes.
- Passengers need to be at the airport 1 hour before their flight in order to book in.
- He wants to get the cheapest flight possible.

Which flight would Mr Dhlamini book? State the flight number (SA...) and show all your working.



## Marking guidelines

### Paper 2: Marking guidelines

The following table shows the percentage of marks allocated to each of the levels of the taxonomy in this Paper 2 examination paper.

Taxonomy Level	Paper 2	
	% of paper	Required
Level 1 – Knowing	0%	0%
Level 2 – Routine procedures	23%	25% (±5%)
Level 3 – Multi-step procedures	36%	35% (±5%)
Level 4 – Reasoning and reflecting	41%	40% (±5%)

Question	Working	Taxonomy Level and Marks				Comment / analysis
		TL 1	TL 2	TL 3	TL 4	
		1.1	R10 260 - R9 756 <b>va(values) = R504vca</b>		2	
1.2	R54 200 <b>va</b>		1			<i>Finance: Taxation</i> Testing the understanding of certain taxation-based terms as well as reading a table of information.
1.3	Any sensible reason (e.g. Salaries increase year on year and so should the tax OR to account for the increase in prices caused by inflation ) <b>vava</b>				2	<i>Finance: Taxation</i> Testing the understanding of certain taxation-based ideas

## Marking guidelines

Question	Working	Taxonomy Level and Marks				Comment / analysis
		TL 1	TL 2	TL 3	TL 4	
1.4.1	Annual Salary = 12 x <b>vm</b> R18 125 = R217 500,00 <b>vca</b> Therefore Tax bracket 3. <b>vca</b>		3			<i>Finance: Taxation</i> Testing the understanding of certain taxation-based terms as well as reading a table of information.
1.4.2	Tax bracket 2 <b>va</b>		1			<i>Finance: Taxation</i> Testing the understanding of certain taxation-based terms as well as reading a table of information.
1.5	Tax Bracket 3: Total Tax = R43 260+30% of amount over R210 000 <b>va</b> = R43 260 + 30% of (R217 500 <b>vm</b> - R210 000) = R43 260 <b>vm</b> + 0,3 x R7 500 <b>vm</b> = R43 260 + R2 250 = R45 510,00 <b>vca</b> Less rebate: R45 510,00 - R9 756,00 <b>vm</b> = R35 754,00 <b>vca</b>			6		<i>Finance: Taxation</i> Testing the ability to calculate income tax using an income tax table and a previously calculated value of taxable income.
1.6	Monthly tax amount = R35 754 ÷ 12 <b>vm</b> = R2 979,50 Net monthly Salary = R16 350,00 <b>vm</b> - R2 979,50 = R13 370,50 <b>vca</b>		3			<i>Finance: Taxation</i> Testing the ability to use a previously calculated amount of income tax and determine the net monthly salary.
1.7	Decrease in tax = R35 754 - R34 315 = R1 439,00 % decrease = decrease ÷ original x 100 = R1 439,50 <b>va</b> ÷ R35 754,00 <b>vm</b> x 100 = 4,03% <b>vca</b>		3			<i>Basic Skills: Percentage</i> Testing the concept of percentage decrease.
1.8.1	347 208 <b>vm</b> - 144 783 <b>vm</b> = 202 425		2			<i>Data Handling: Organizing Data</i> Testing the ability to utilize appropriate values from a table

## Marking guidelines

Question	Working	Taxonomy Level and Marks				Comment / analysis
		TL 1	TL 2	TL 3	TL 4	
						of data to perform calculations.
1.8.2	$40\,848 \text{ va} \div 202\,425 \text{ vca} \times 100 = 20,18\% \text{ vca}$		3			<i>Probability: Expressions of probability</i> Testing the ability to perform basic probability calculations using data in table form.
1.8.3	Coloured person = $184\,025 \text{ va} / 1\,056\,076 \text{ va} \times 100 = 17,42\%$ White person = $224\,222 \text{ va} / 1\,606\,631 \text{ va} \times 100 = 13,96\% \text{ va}$ <b>(comparing either percentages or decimals)</b> Therefore more likely for coloured person <b>va</b> (Note: could also have calculated the totals of internet users only. Will give the same result)				6	<i>Probability: Prediction</i> Testing the ability to perform appropriate calculations involving probability and represent those probabilities in such a way that they can be compared.
1.9.1	Less likely. <b>va</b> The table shows that many more black users access the internet through cellphones and this is the major population grouping in South Africa and so this is where the growth will occur. <b>va</b>				2	<i>Probability: Prediction</i> Testing the ability to make predictions for a course of action based on the data on hand and the likelihood of various outcomes.
1.9.2	Grow in cellphone internet <b>va</b> coverage. It is the largest way that people are accessing the internet and it is sure to grown. <b>va</b>				2	<i>Data Handling: Interpreting and analysing data</i> Testing the ability to make decisions based on the data represented.

## Marking guidelines

Question	Working	Taxonomy Level and Marks				Comment / analysis
		TL 1	TL 2	TL 3	TL 4	
2.1	Loan factor = 9,32 <b>Va</b> Monthly repayment = $(R1\ 200\ 000 \div 1\ 000) \times 9,32$ <b>Va</b> = R11 184 <b>Vca</b>			3		<i>Finance: Loans</i> Testing the ability to use loan tables to calculate monthly repayment amounts.
2.2	30% <b>Va</b> of R156 222 = R46 899,60 per year = R3 905,55 per month <b>Va</b> Monthly repayment = $(500\ 000 \div 1\ 000) \times 8,05$ <b>VaVa</b> = R4 025,00 <b>Vca</b> Therefore, no would not be able to afford such a house. <b>Va</b>				6	<i>Finance: Loans</i> Testing the ability to use loan tables to calculate monthly repayment amounts and think critically to confirm whether or not a loan could be granted under given conditions.
2.3.1.a	The value is always decreasing. <b>Va</b> The last two years it decreased at the same rate. <b>Va</b>				2	<i>Finance: Investments</i> Testing the ability to read ALL of the information given in graphical form and make informed decisions from that information.
2.3.1.b	The value is always increasing. <b>Va</b> . The last increase is lower than the middle one. <b>Va</b> .				2	<i>Finance: Investments</i> Testing the ability to read ALL of the information given in graphical form and make informed decisions from that information.
2.3.1.c	Their <i>rates</i> are different by 17,24%, <b>Va</b> but the rates of change have been compounded (so they include previous percentages). <b>Va</b> .				2	<i>Finance: Investments</i> Testing the ability to read ALL of the information given in graphical form and make informed decisions from that information.
2.3.2	Year 1: 21,18% of R1 200 000 = R254 160. <b>Va</b> End of year 1: Value =			6		<i>Finance: Inflation</i> Testing the ability to increase a



## Marking guidelines

Question	Working	Taxonomy Level and Marks				Comment / analysis
		TL 1	TL 2	TL 3	TL 4	
	$R1\ 200\ 000 + R254\ 160$ $= R1\ 454\ 160$ . <b>Va</b> Year 2: 32,24% . <b>Va</b> of $R1\ 454\ 160 = R468\ 821,18$ . <b>Vca</b> End of year 2: Value = $R1\ 454\ 160 + R468\ 821,18$ $= R1\ 922\ 981,18$ Year 3: 22,72% . <b>Va</b> of $1\ 922\ 981,18 = R436\ 901,32$ End of year 3: Value = $R1\ 922\ 981,18 + R436\ 901,32$ $= R2\ 359\ 882,50$ . <b>Vca</b>					given amount in a compound series of increases when each increase is by a different percentage.
2.3.3	The house <b>Va</b> is a better investment because it will grow. <b>Va(or other comment on house)</b> Whereas a car is not an investment at all and it will decrease in value instead. <b>Va (or other comment on car)</b>				3	<i>Finance: Investments</i> Testing the ability to refer to previous work and make a critical decision based on the calculated answers.
3.1	Height: 1,7 m <b>Va</b> Width: 6,2 m <b>Va</b>		2			<i>Maps, Plans, etc.: Plans</i> Testing the ability to work out missing dimensions from existing elements of a plan or drawing.
3.2	Note: This scale may be different if the page has been photocopied but the method remains the same. Measurement on the view (e.g. left side): 3 cm <b>Va (within 2mm)</b> Actual measurement: 2,4 m <b>Va</b> Change units: 2,4 m = 240 cm <b>Va</b> Scale: Real ÷ measurement = $240\text{ cm} \div 3\text{ cm}$ <b>Va</b> $= 80$ Scale = 1 : 80 <b>Vca</b>			5		<i>Maps, Plans, etc.: Scale</i> Testing the ability to calculate a scale from a measurement taken on the drawing.
3.3	Using scale: Measurement in drawing:			3		<i>Maps, Plans, etc.: Plans</i>

## Marking guidelines

Question	Working	Taxonomy Level and Marks				Comment / analysis
		TL 1	TL 2	TL 3	TL 4	
	5,6 cm <b>Va (within 2 mm)</b> Convert using scale: 5,6 cm x 80 = 448 cm <b>Vca</b> Answer in metres: 4,48 m <b>Vca</b>					Testing the ability to utilize a calculated scale to work out a missing dimension.
3.4	Break up area into a rectangle and a triangle: Area of rectangle = 1,7 m x 4,4 m <b>Va (dimensions)</b> = 7,48 m <sup>2</sup> <b>Vca</b> Area of triangle = 0,5 x 0,7 m x 4,4 m <b>Va (dimensions)</b> = 1,54 m <sup>2</sup> <b>Vca</b> Total area = 7,48 + 1,54 = 9,02 m <sup>2</sup> <b>Vca</b>			5		<i>Measurement: Calculating Area</i> Testing the ability to break down a complex shape into component areas in order to work out the total area of the shape.
3.5.1	Area covered by 1 brick = length x breadth <b>Vm</b> = 412 mm x 202 mm = 0,412 m x 0,202 m <b>Va (dimensions including mortar) Va (converted to m)</b> = 0,083224 m <sup>2</sup>				3	<i>Measurement: Calculating Area</i> Testing the ability to work towards an answer and think critically about how to get to an unfamiliar solution.
3.5.2	No. of bricks = total area ÷ area of 1 brick <b>Vm</b> = 9,02 m <sup>2</sup> ÷ 0,083224 m <sup>2</sup> /brick <b>Va (values)</b> = 108,38 bricks <b>Vca</b> 108 or 109 bricks <b>Vca</b>		4			<i>Measurement: Calculating Area</i> Testing the ability to divide a smaller area into a larger one in order to work out a quantity.
3.5.3	Any reasonable answers (e.g. The wall being slanted changes the number of bricks being used on the top OR breakages could mean more bricks are needed OR some bricks are not needed due to the bricks on the corner being from the other wall. <b>VaVa</b>				2	<i>Measurement: Calculating Area</i> Testing the ability to think critically about previously calculated answers.
3.6	When the sheets overlap <b>Va</b> each other, the bit of overlap on the ends reduces the effective width. <b>Va</b>	3			2	<i>Measurement: Calculating length</i> Testing the ability to analyse a given situation critically.

## Marking guidelines

Question	Working	Taxonomy Level and Marks				Comment / analysis
		TL 1	TL 2	TL 3	TL 4	
3.7	$6,2 \text{ m} = 6\,200 \text{ mm}$ <b>Va</b> No. of sheets = $6\,200 \text{ mm} \div 665 \text{ mm}$ <b>Va</b> = 9,32 sheets <b>Vca</b> Therefore 10 sheets will be required <b>Vca (rounding up)</b>			4		<i>Measurement: Calculating Length</i> Testing the ability to use an effective width (as opposed to a physical width) to work out how many sheets will be required. Rounding is also assessed.
4.1	Mean = Total $\div$ no of data $= 2\,074$ <b>Va</b> $\div 12$ <b>Va</b> $= 172,83 \text{ cm}$ <b>Vca</b>		3			<i>Data Handling: Summarising data</i> Testing the ability to perform a simple mean calculation
4.2	169 170 170 170 171 171 172 172 174 175 175 185 <b>Va (data ordered shortest to tallest)</b> Two middle values are 171 cm & 172 cm Median = $(171 \text{ cm} + 172 \text{ cm}) \div 2$ <b>Vm</b> $= 171,5 \text{ cm}$ <b>Va</b>		3			<i>Data Handling: Summarising data</i> Testing the ability to perform a simple median calculation
4.3	The median <b>Va</b> will be more accurate as the mean is distorted by the single very large height (185 cm) which is called an outlier. <b>Va</b>			2		<i>Data Handling: Analysing data</i> Testing the ability to think critically about various representations of the 'Average'
4.4	Girls and boys grow at different rates <b>Va</b> and so we are not finding the average of the same data. <b>Va</b> The average of the data would be meaningless due to the major differences in development of the two sexes.			2		<i>Data Handling: Summarising data</i> Testing the ability to think critically about the data being represented.
4.5	$Q_2 = \text{median} = (62 \text{ kg} + 64 \text{ kg}) \div 2 = 63 \text{ kg}$ <b>Va (values)</b> <b>Vca</b>		2			<i>Data Handling: Summarising data</i> Testing the ability to identify $Q_2$ as the median.

## Marking guidelines

Question	Working	Taxonomy Level and Marks				Comment / analysis
		TL 1	TL 2	TL 3	TL 4	
4.6	Quartile 1 = $(58 \text{ kg} + 61 \text{ kg}) \text{ va (values)} \div 2 = 59,5 \text{ kg}$ Quartile 3 = $(69 \text{ kg} + 72 \text{ kg}) \text{ va (values)} \div 2 = 70,5 \text{ kg}$ <b>vm (both)</b>			3		<i>Data Handling: Summarising data</i>  Testing the ability to calculate Q1 and Q3.
4.7.1	The top 25% <b>va</b> of the data is very spread out <b>va</b>				2	<i>Data Handling: Interpreting data</i>  Testing the ability to use quartiles and percentiles in interpreting data
4.7.2	Q1: 55 kg <b>va (+ or - 1 kg)</b> Q2: 61 kg <b>va (+ or - 1 kg)</b> Q3: 69 kg <b>va (+ or - 1 kg)</b>			3		<i>Data Handling: Representing data</i>  Testing the ability to read data off a box and whisker plot
4.7.3	Looking at the various statistical measurements: The minimum for the group is higher than the minimum for the school and the maximum is less than the school's maximum. This means is that neither of the outliers are in this group of boys. Q1, Q2 & Q3 for the group are all higher than those for the boys in the school indicating that the group is heavier than the average 16-year old boy in the school. Also the weights of the boys in the group are not as spread out as the school because the whiskers are smaller and the box is also narrower than the school's values.				4	<i>Data Handling: Interpreting data</i>  Testing the ability to perform a detailed analysis of representations of data (specifically the box-and-whisker plot)

## Marking guidelines

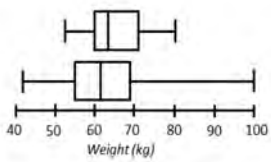
Question	Working	Taxonomy Level and Marks				Comment / analysis
		TL 1	TL 2	TL 3	TL 4	
	 <p><b>Va (comment on max / min)</b>  <b>Va (comment on Q1, Q2, Q3 values)</b>  <b>Va (interpretation of Q1, Q2, Q3 values)</b>  <b>Va (accurate comment on the spread of the values in the group relative to the school)</b></p>					
4.8.1	He is shorter <b>Va</b> than the average. The 'average' would be the 50th percentile <b>Va</b> and so his height is lower than that.				2	<i>Data Handling: Analysing data</i> Testing the ability to interpret data with reference to percentiles
4.8.2	His weight is near the top of the <b>Va</b> collected weights for 15-year olds. This is not healthy <b>Va</b> for a short <b>Va</b> person.				3	<i>Data Handling: Analysing data</i> <i>Measurement: Measuring weight/length</i> Testing the ability to utilize previously analysed data and combine it with newly analysed data.
4.8.3	$169 \text{ pound} \div 2,2 \text{ Vm} = 76,81 \text{ kg Va}$ $169 \text{ cm} = 1,69 \text{ m Va}$ $\text{BMI} = 76,81 \text{ kg} \div (1,69 \text{ m})^2 \text{ Vm}$ $= 76,81 \text{ kg} \div (2,8561 \text{ m}^2)$ $= 26,89 \text{ kg/m}^2 \text{ Vca}$			5	<i>Measurement: Converting &amp; Measuring weight/length</i> Testing the ability to convert between two different systems of measurement as well as using the BMI calculation.	

## Marking guidelines

Question	Working	Taxonomy Level and Marks				Comment / analysis
		TL 1	TL 2	TL 3	TL 4	
4.8.4	The BMI occurs just outside the 95th percentile <b>Va Va</b> and so the boy is overweight. <b>Va</b>				3	<i>Data Handling: Analysing data</i> <i>Measurement: Measuring weight/length</i> Testing the ability to analyse data using percentiles as well as having a knowledge of the meaning of BMI
4.8.5	A BMI of 26,89 for a 20-year old boy (man) occurs just under the 85th percentile. <b>Va</b> He will therefore have a healthy weight. <b>Va</b>				2	<i>Data Handling: Analysing data</i> <i>Measurement: Measuring weight/length</i> Testing the ability to analyse data using percentiles as well as having a knowledge of the meaning of BMI.
5.1	Earliest flight = 5:45 <b>Va</b> + 1:20 + 1:00 = 8:05 am <b>Va</b> Therefore first two cheap flights are ruled out. <b>Va</b> The last two flights are ruled out <b>Va</b> because they arrive too late. <b>Va</b> The only cheap flight remaining is <b>SA7981. Vca</b>				6	<i>Maps, Plans, etc: Maps</i> Testing the ability to utilize given limits to make time-based planning decisions.
5.2	Distance from Bloemfontein to Cape Town is 997 km. <b>Va</b> Therefore total distance is 997 + 586 = 1 583 km. <b>Vca</b> NOTE: The given distance from PMB to CT is 1 677 km but this is via another route.		2			<i>Maps, Plans, etc: Maps</i> Testing the ability to read a distance table
5.3	$1\,583 \div 100 \text{ km/h} = 15,83$ hrs <b>Vca</b> $0,83 \text{ hrs} \times 60 = 50 \text{ mins}$ <b>Vm</b> Total time = 15 hrs 50 mins <b>Vca</b>			4		<i>Maps, Plans, etc: Maps</i> Testing the ability to perform calculations with speed in order to make journey planning decisions

## Marking guidelines

Question	Working	Taxonomy Level and Marks				Comment / analysis
		TL 1	TL 2	TL 3	TL 4	
5.4	<p>Total fuel needed = <math>1\,583 \text{ km} \div 100 \text{ km} \times 8,1 \text{ l} = 128,223 \text{ l}</math></p> <p>Cost of fuel = <math>128,223 \text{ l} \times \text{R}11,88/\text{l} = \text{R}1\,523,29</math></p> <p>Total fuel costs = <math>\text{R}1\,523,29 \times 2 = \text{R}3\,046,58</math></p> <p>Wear &amp; tear costs = <math>\text{R}0,3943 \times (1\,583 \text{ km} \times 2) = \text{R}1\,248,35</math></p> <p>Total costs = <math>\text{R}1\,248,35 + \text{R}3\,046,58 = \text{R}4\,294,93</math></p>			7		<p><i>Maps, Plans, etc: Maps</i></p> <p>Testing the ability to determine the operating costs of a vehicle including fuel and maintenance considerations.</p>
5.5	<p>He should fly. It is much more expensive to fly, but there are other costs that have not been considered (e.g. overnight accommodation on the journey, car break down). Also, it will take a long time to drive to Cape Town whereas a flight will enable him and his family to enjoy much more of their holiday.</p> <p>OR: He should drive. It is much cheaper (especially if he drives the whole trip in a day (NOT ADVISABLE)) and at least he will have a car available when they get to Cape Town.</p>				2	<p><i>Maps, Plans, etc: Maps</i></p> <p>Testing the ability to critically consider travel options and make informed decisions about the available options.</p>
	<b>Total (%)</b>	<b>0</b>	<b>23</b>	<b>36</b>	<b>41</b>	