

SA's Leading Past Year

Exam Paper Portal

STUDY

You have Downloaded, yet Another Great Resource to assist you with your Studies 😊

Thank You for Supporting SA Exam Papers

Your Leading Past Year Exam Paper Resource Portal

Visit us @ [www.saexampapers.co.za](http://www.saexampapers.co.za)



SA EXAM  
PAPERS



Province of the  
**EASTERN CAPE**  
EDUCATION

**NATIONAL  
SENIOR CERTIFICATE**

**KEREITI 12**

**LWETSE 2020**

**DISAENSE TSA BOPHELO P1**

**MATSHWAO: 150**

**NAKO: Di hora tse 2½**

---

Pampiri ena ena le maqephe a-16.

---

**DITAELO LE DIKELETSO HO MOHLAHLOBUWA**

Bala ditaelo tsena ka hloko pele o qala ho araba dipotso.

1. Araba potso tsena kaofela.
2. Ngola dikarabo bukeng ya dikarabo.
3. Qala Karabo ka enngwe le enngwe leqepheng le letjha.
4. Nomora dikarabo tsa hao jwalo ka ha di potso di monomorilwe pampiring ya potso.
5. Ngola dikarabo tsa ha oho latela ditaelo tse potsong enngwe le enngwe.
6. Etsa didrawing ka pensile hape o etse dilabel ka pene entsho kapa e putswa.
7. Etsa didiagramo, ditabole kapa difulo tjhati ho o ho tjhiwo jwalo.
8. Didiagramo tse pampiring ena adiya latela ditekanyo.
9. O seke wa sebedisa pampiri ya graph.
10. O ka sebedisa calculatara esa programwang, di diprotractora moho di kampase m oho hlokahalang.
11. Ngola ka mongolo o makgethe mme o balehang.

**KAROLO A****POTSO YA 1**

1.1 Lithathamong la dikarabo potsong e nngwe le enngwe. Khetha o nngole karabo e nepa hetseng (A–D) pela nomoro ya potso (1.1.1–1.1.8) bokaneng ya DIKARABO, mohlala 1.1.9 D.

1.1.1 Ka Meiosis II ...

- A dikromosomo di hlophisitwe bohareng bala sele ho homologous pair.
- B lenane la dikromosomo le arotswe ha bedi.
- C dikromosomo li hlophisitswe ka bonngwe bohareng ba sele.
- D dikromosomo tse feletseng di a mahlakoreng amabedi a arohaneng a sele.

1.1.2 Ke karolo e feng ya botuna e hlahisang (secreting) testosterone?

- A Vas deferens
- B Testis
- C Seminal vesicle
- D Prostate gland

1.1.3 Tshebetso eo ova e hlahiswang ho yona e tsoa ho jeminali (germinal) epithelium ya mae a bomme e tsejoa e le ...

- A gametogenesis.
- B oogenesis.
- C spermatogenesis.
- D ovulation.

1.1.4 Ganglion ke ...

- A ditsitiso methapong ya mali.
- B pokello ya di sele tse kenyang (secreting) dihomone maling.
- C Mofuta wa sele ya methapo (nerve cell) e amehang ketsonng ya reflex action.
- D pokello ya mele ya disele tsa methapo.

1.1.5 Ha tekanyo ya tsoekere ya mali e phahama, mele o amohela hanghang ho theola boemo ka ho (sekreta ) ...

- A glycogen.
- B insulin.
- C glucagon.
- D adrenalin.

- 1.1.6 Setsoantso se ka tlase se bontsa tsila (direction) ya kgolo ya plumuli dithopo 1, 2, 3 le 4 tse fapaneng tse kentsweng le bokoseng. Metsu (arrows) e bontsa ho tsila ya khanya.

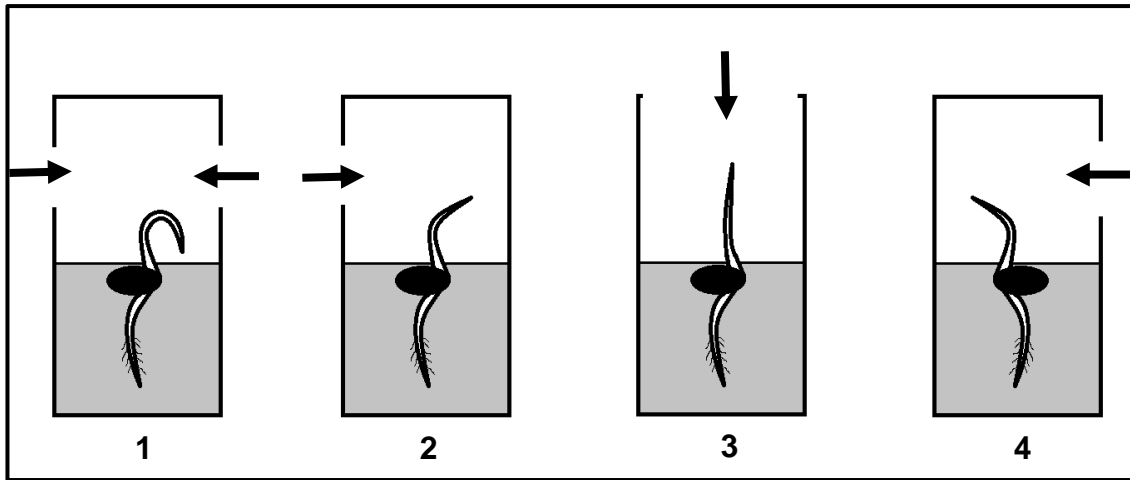

Ke sefeng ya sethopo e kaholimo e bontsang karabo e nepahetseng leseli (khanyeng)?

- A 1
- B 2
- C 3
- D 4

- 1.1.7 Ke efeng ya dikarabo tse latelang e lebelletsweng haeba malebela a hola a peo (seedlings) 4 a khaolwa kamora dibeke tse 4 tsa kholo?

- A Semela se tla shwa
- B Makala a hamorao a tla thehwa
- C Semela se tla emisa ho holaTh
- D Kutu ya semela e tla hola ho fihlela matla a khoheli (ho ya o gravity)

1.1.8 Graph e ka tlase e bontsa sephetho sa patlisiso mabapi le phallo ya khatello ya joala ya mali nakong ya karabelo.



Re ka fihlela qeto efe mabapi le lipatlisiso tse bontsitsweng ka holimo?

Boemo bo phahameng ba khatello ya jwala ba mali ...

- A ha e ame/fetole (effect) ho nako ya karabelo (reaction).
- B e fokotsa nako ya ho arabela.
- C e eketsa bokhoni ba motho ba ho arabela ka potlako.
- D e eketsa nako ya ho arabela.

(8 x 2) (16)

- 1.2 Fana ka polelo e nepahetsing ea tlhaho ( biologicali) ho e nngwe ea litlhaloso tse latelang. Ngola feela polelo haufi le dinomoro tsa dipotso (1.2.1–1.2.7) BUKENG YA LIKARABO.
- 1.2.1 Ho eketseha ha bophara (diameter) ba methapo ya mali e le hore mali a mangata a phallele ho tsona
- 1.2.2 Setsi se laolang motjheso bokong
- 1.2.3 Ketsahalo yeo ho yona ho eketseha ha (hormone) e le nngwe ho thibelang secretion ho hormone e nngwe
- 1.2.4 Karolo ya methapo ya kutlo e fokotsang (autonomiki) ho otlwa ha pelo ho kgutlela ho hotlwalehileng
- 1.2.5 Hormona e laolang ho hokahana (consentrationi) ha letswayi meleng wa motho
- 1.2.6 Sebaka sa phetisetso (transmission) sa methapo ya motlakase dipakeng tsa lisele tse peli tsa methapo (dinyuroni) kapadipakeng tsa dinyuroni le (glandi) kapa glandi le mesifa
- 1.2.7 Setho sa nakwana se hokahanyang leseyo le holang ka (umbilical cord) ka popelong (7 x 1) (7)
- 1.3 Bontsa hore na ditlaloso tse ho COLUMN I disebeta ho **A FELA, B FELA, A LE B** or **HAYIYO** tsa dintho (items) tse ho COLUMN II. Ngola **A fela, B fela, A le B** or **hayio** pela nomoro ya dipotso (1.3.1–1.3.3) e bukeng ya dikarabo.

COLUMN I		COLUMN II	
1.3.1	Di gland tsa endocrine meleng wa motho	A:	Cowper's gland
		B:	Gastric glands
1.3.2	Mothapo wa mali o fetisang oksijene le dimatlafatsi tse ding ho tloha meleng wa ma (mme) ho ya ho (foetus)	A:	Umbilical vein
		B:	Umbilical cord
1.3.3	E tlisa di elongation tsa di internodes	A:	Gibberellins
		B:	Abscisic acid

(3 x 2) (6)

1.4 Setswantso se ka tlase se bontsa dibaka (A, B le E) tsa tsebetso ya methapo e ka thibelwang ke anaesthetic (sethethefatsi kapa moemeli ya hlahisang maikutlo a felletseng kapa a sa utlwahaleng) litsebetsong tse fapaneng tsa bongaka (surgical procedure)

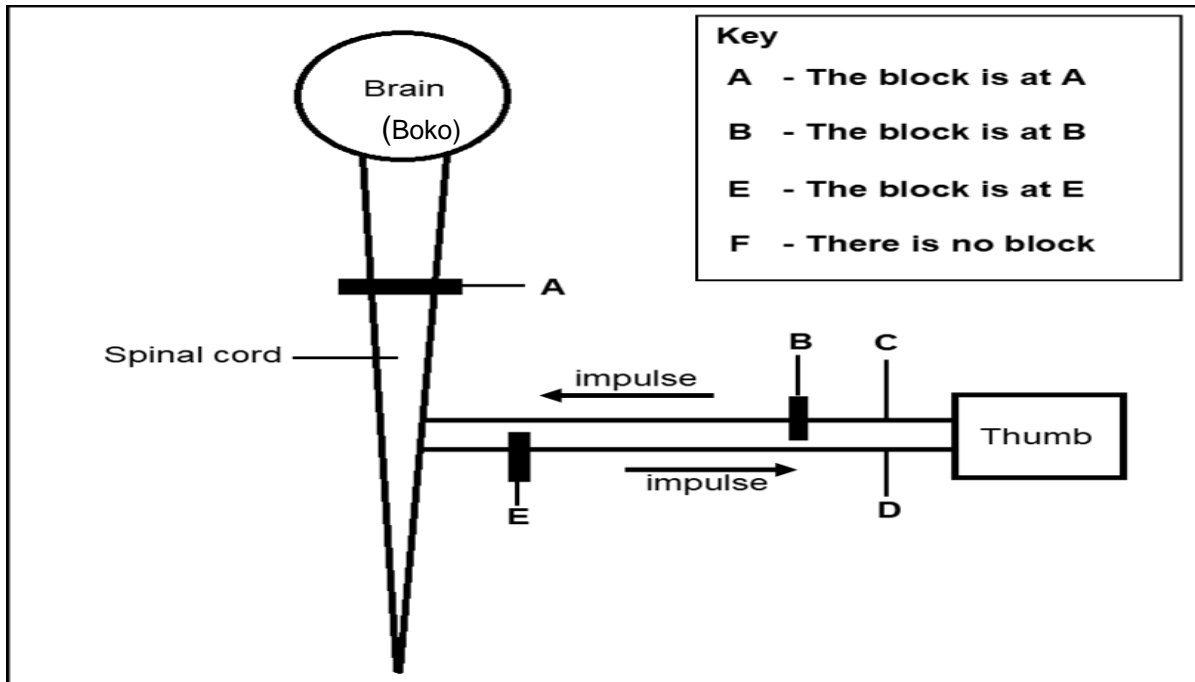

1.4.1 Ngola thlaku e nepahetseng bakeng sa polelo e nngwe le e nngwe u sebedisa senotlolo se faneng ho setswantso (diagram).

- (a) Ha letlalo la monwana le hlohlellitswe (stimulated), monwana o motuna le letsoho di tsamaya ka boithatelo, empa mokudi a keke a sisinya letsoho lahae ka boithaopo kapa a utlwa a sisinyeha. (1)
- (b) Mokuli a ka utlwa hore monwana o motuna wa letsoho o angwe kapawa pikitla, empa a sitwa ho sisinya monwana o motuna. (1)
- (c) Mokuli a ka sisinya monwana o motuna, empa a sitwa ho utlwa ho sisinyeha. (1)
- (d) Ha letlalo la monwana o motuna le hlohlellitswe (stimulated), monwana o motuna wa letsoho wasisinyeha, me mokuli wa tseba hore wa sisinyeha. (1)

1.4.2 E bitswang karolo ya methapo ya methapo (central nervous system) e tla ameha ka matla ho hlahisa karabelo e potlakileng ho motho ya phetseng hantle, ha monwana o motuna wa letsoho o ama sebaka se tjhesang? (1)

1.4.3 Bolela mofuta wa karabelo e boletsweng POTSONG YA 1.4.2. (1)

1.4.4 Ke dikarolo difeng tse peli tse bontsitsweng setsowantswong (diagrama) tse sirelelitswe ka (meninges)? (2)

1.4.5 Fana (Identify) ka tlhaku (letter) e emetsing (neve) ya pheriphara nerve e entsweng ka:

- (a) Sensory neurons (1)
- (b) Motor neurons (1)



- 1.5 Setswantso (diagram) se ka tlase se bontsa litho tsa botsehali (female). Methapo e meli e ne e hokahane ka mokhoa wa ho buuo a ho thibela ho ima (pregnancy).

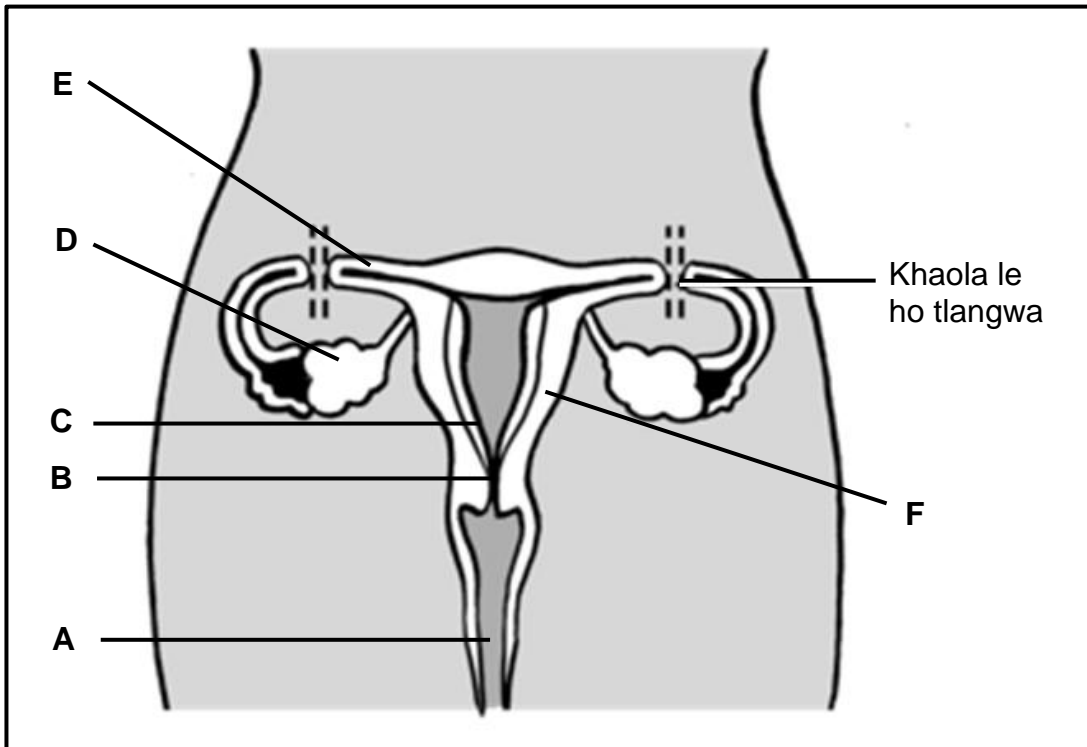

- 1.5.1 Hlwaya:

- (a) **A** (1)  
 (b) **B** (1)  
 (c) **F** (1)

- 1.5.2 Fana ka **THLAKU** le **LEBITSO** la karolo:

- (a) Moo embryo e kentsweng / hlommeng teng (implanted) (2)  
 (b) Seo se hlahisang ova (2)  
 (c) Moo (fertilisation) e tswanetsing ho etsahala teng (2)

- 1.5.3 Mokhwa wa o etsa (surgical) o boletsweng kaholimo o thibela ima (pregnancy) joang? (1)

- 1.5.4 Fana ka lebaka la mokhwa wa (surgical) e **entsweng** li-tubes ka bobeli. (1)

**MATSHWAO OHLE A KAROLO YA A: 50**

**KAROLO B**

**POTSO 2**

2.1 Setshwantso sena se ka tlase se bontsha mehato (dikaralo) e mmedi ya meiosis.

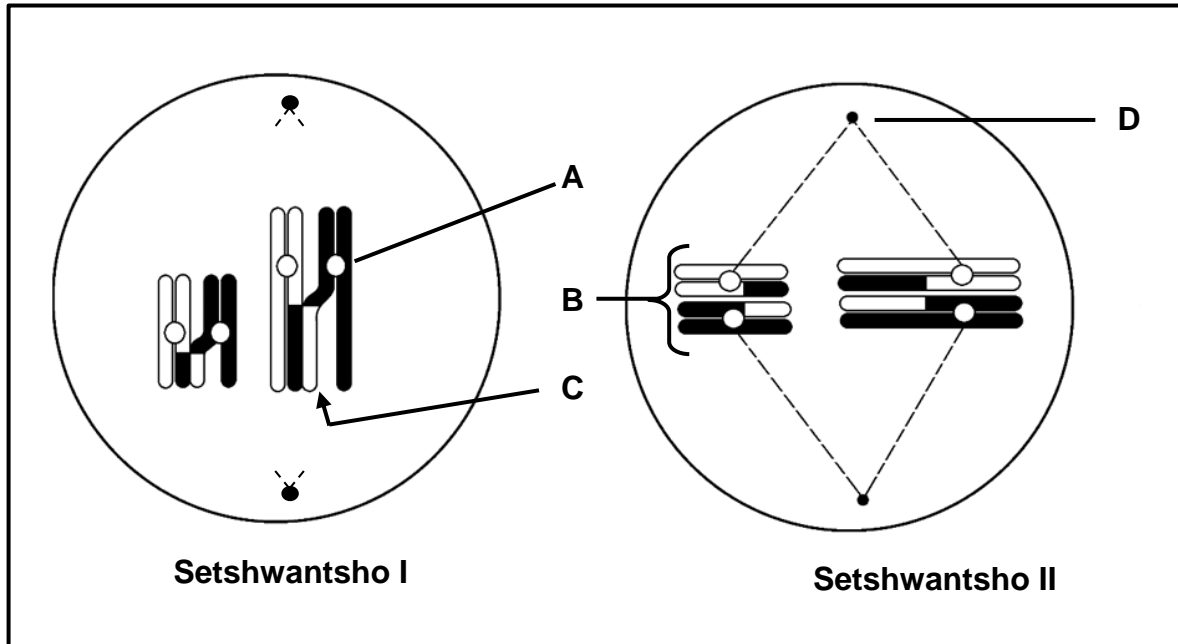

2.1.1 Hlwaya/Bolela hore na ke karolo efe ya meiosis e bontshitsweng ke:

(a) **Setshwantsho I** (1)

(b) **Setshwantsho II** (1)

2.1.2 Hlwaya/Bolela/fana ka:

(a) **A** (1)

(b) **B** (1)

(c) **D** (1)

2.1.3 Hlalosa ketsahalo/porosese e etsahalang ho **C**. (4)

2.1.4 Hlalosa tlhakiso ya ketsahalo e bontshitsweng ho setshwantsho II. Explain the significance of the event shown in **Diagram II**. (3)

2.2 Setshwantsho se ka tlase se bontsha o mong wa mekgwa e hlahelletseng wa kgodiso (developmental strategies) mofutennng o itseng wa nonyana.

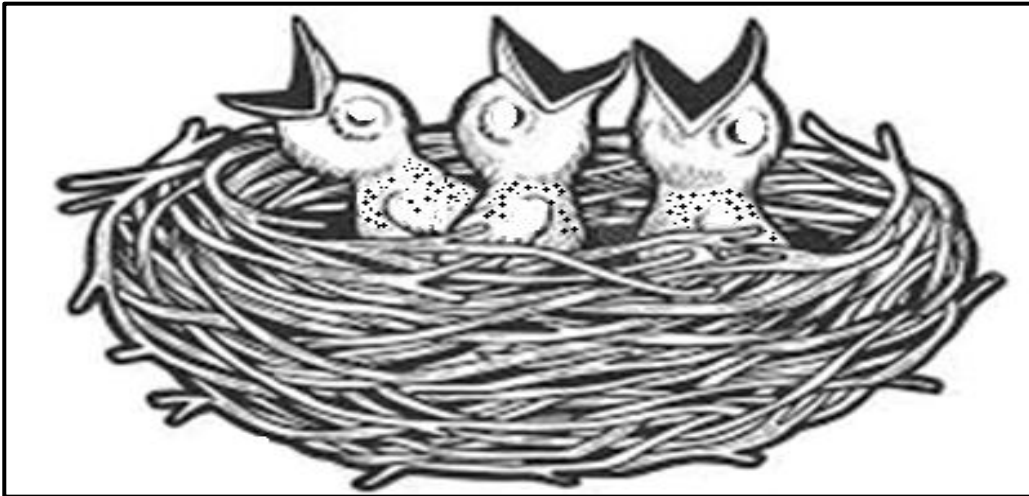

- 2.2.1 Bolela hore ke mokgwa o feng wa kgodiso (developmental strategies) o bontshitsweng setshwantshong. (1)
  - 2.2.2 Fana ka mabaka a mararo a bonahalang ho tshehetsa Karabo YA POTSONG 2.2.1. (3)
  - 2.2.3 Bolela bofokodi bo le bong ba mokgwa ona wa kgodiso (developmental strategy). (1)
  - 2.2.4 Hlalosa ponahalo ya ditsuonyana o bue ka mahe a tsona. (2)
- 2.3 Setshwantsho se ka tlase se bontsha sebopelo sa leihlo se nang le phoso.

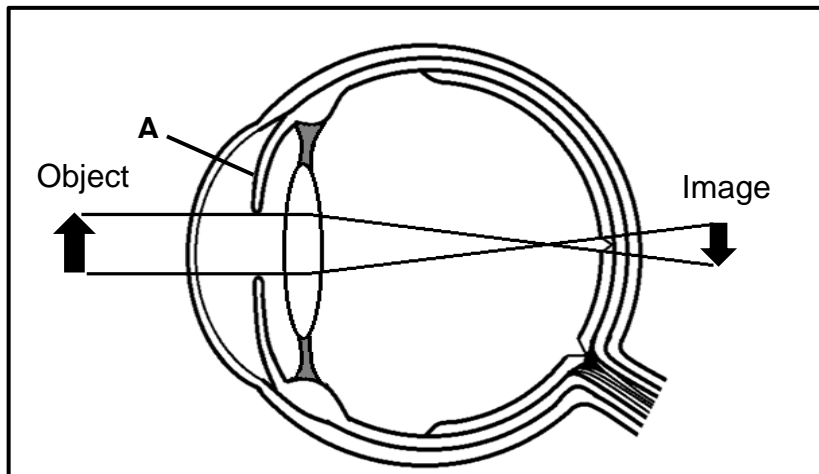

- 2.3.1 Bolela bofokodi/phoso e bontshitshweng setswantshong. (1)
- 2.3.2 Sebedisa setshwantsho sena ho hlalosa ka moo bofokodi bona ba sebopelo bo bontshitsweng setshwantshong bo bakang boemo bo boletsweng POTSONG YA 2.3.1. (4)
- 2.3.3 Bolela tsela e le ngwe yeo boemo bona bo ka lokiswang ka yona. (1)
- 2.3.4 Hlalosa hore na karolo ya **A** e laola jwang khanya e kenang, ha khanya e fokola kamorao hore letsatsi le dikele. (4)

2.4 Graph e ka tlase e bontsha tekanyo ya dihomone tsa botshehadi ka nako ya menstrual cycle.

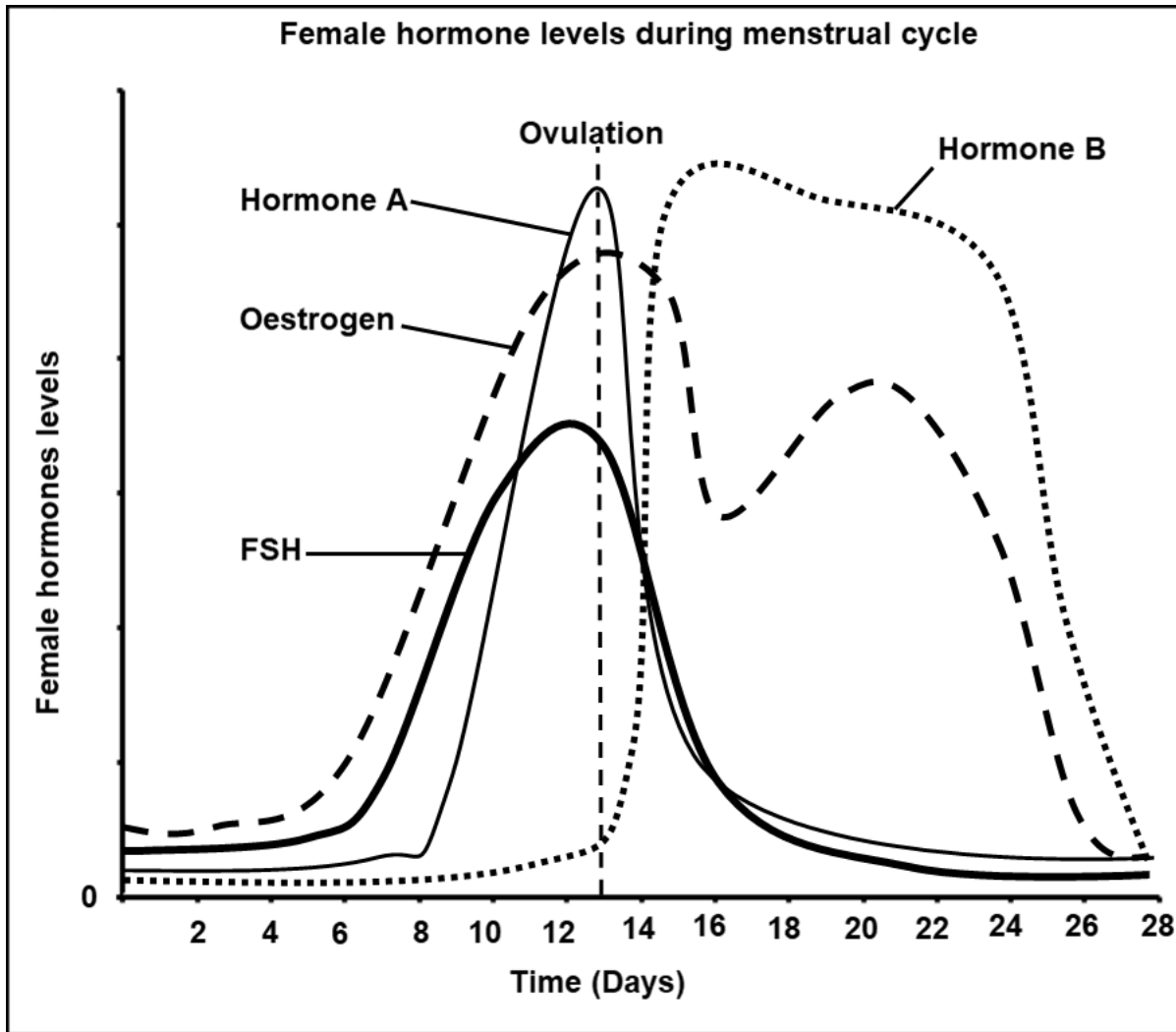

- 2.4.1 Bolela hore na hormone **A** ke eng. (1)
- 2.4.2 Fana ka lebaka la Karabo ya hao ho POTSO YA 2.4.1. (1)
- 2.4.3 Ke ka tsatsing lefe la potoloho moo ho ileng ha etsahala ovulation? (1)
- 2.4.4 Hlalosa tshusumetso ya oestrogen ho endometrium ho tloha ka tsatsi la 7 ho isa ho la 13 la potoloho (cycle). (2)
- 2.4.5 Ke ho theoha ha tekanyo ya homone efe ho bakang menstruation? (1)
- 2.4.6 Bolela lebaka le ka etsang hore tekanyo ya homone **B** e dule e le hodimo le ka morao ho matsatsi a 28 a potoloho (cycle). (2)
- 2.4.7 Hlalosa hore ke hobaneng thlahiso(secretion) ya FSH e thibetswe ke tekanyo e phahameng ya homone B. (3)

[40]

POTSO YA 3

3.1 Teko (Experiment) e ile ya etswa ho fuputsa tshusumetso ya hormone thyroxin boimeng ba mmele ba dihohwana *Xenopus laevis*.

Mokgwa wa ho etsa ene e le o latelang:

- Mekudubete (frog tadpoles) *Xenopus laevis*, tse mashome a mane ametso e mene di ile tsa tshwaswa, tsa ba tsa arolwa dihlopha tse pedi tse lekanang.
- Boimakarolelano (average mass) ba ho qala ba sehlopha ka nngwe bo ile ba balwa pele teko (experiment) e ka qala.
- *Xenopus laevis*, Mekudubete ( frog tadepoles), e mashome a mabedi a metso e mmedi ile e ya phekolwa ka motswako wa thyroxin, ka matsatsi a 21.
- *Xenopus laevis*, mekudubete e mashome a mabedi a metso e mmedi, e ile ya phekolwa ka 1% ya NaOH, ka matsatsi a 21.
- Pheko e ile ya tlohelwa ka mora matsatsi a 2, yaba boimakarolelano (average body mass) ba ho qetela ba sehlopha ka nngwe baa balwa. Sephetho sa teko se fanwe ka tlase.

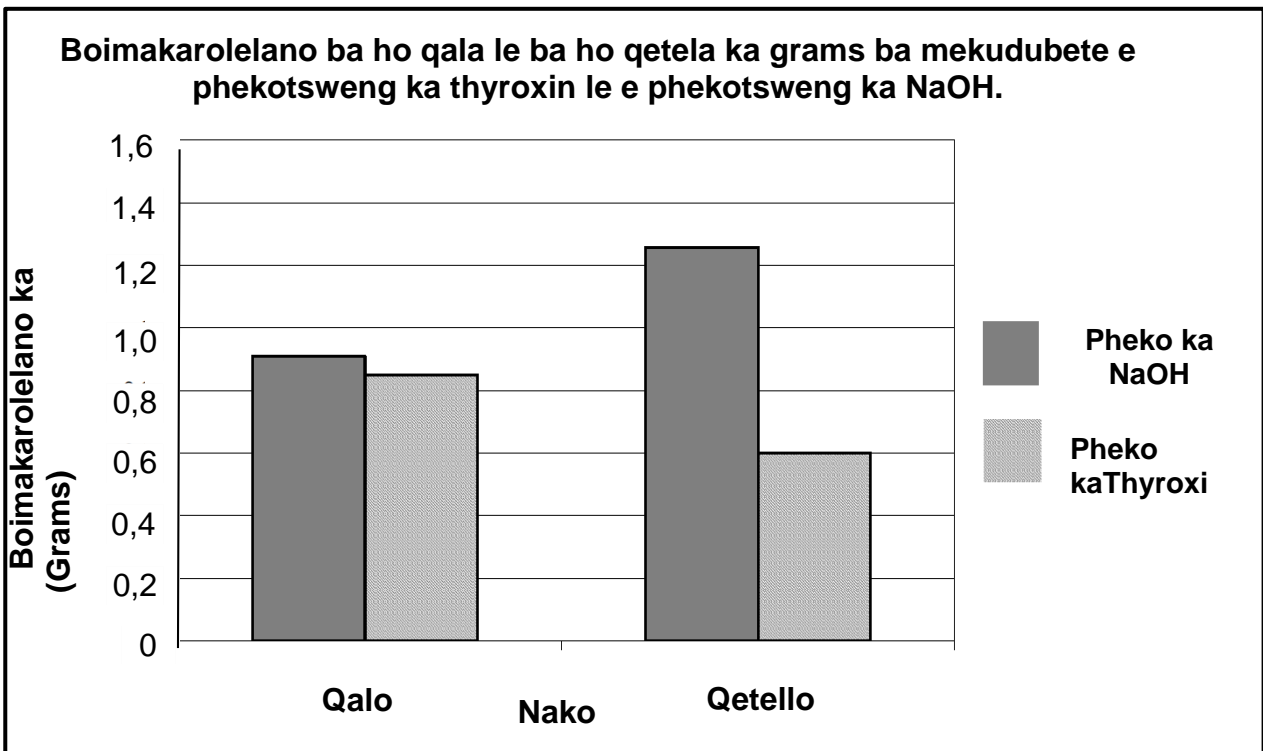

- 3.1.1 Fana ka lebitso la tshwelesa (gland) e hlahisang thyroxin. (1)
- 3.1.2 Hlwaya ntlha e ikemetseng tekong ena. (independent variable). (1)
- 3.1.3 Fana ka dintlha tse pedi tse lokelang ho bolokwa di sa fetohe (constant variables) ka nako ya teko ena. (2)
- 3.1.4 Ke boitsebiso bofe bo bontshitsweng ho graph bo sebedisitsweng e le data ya motheo (baseline data) ho etsa qeto, qetellong ya teko. (1)

3.1.5 Hlalosa hobaneng ha ho na le ho fokotseha ha boima ba mmele ba ho getela ba mekudubete e phekotsweng ka thyroxin papisong le ba tse phekotsweng ka NaOH. (4)

3.1.6 Hlalosa hore na tekanyo e sa fetofetoheng ya thyroxin e ka bolokwa jwang etshwana mading a motho haeba tekanyo e theohela tlase ho boemo bo tlwaelehileng. (5)

3.2 Setshwantsho se ka tlase se bontsha sebopelo sa boko ba motho.

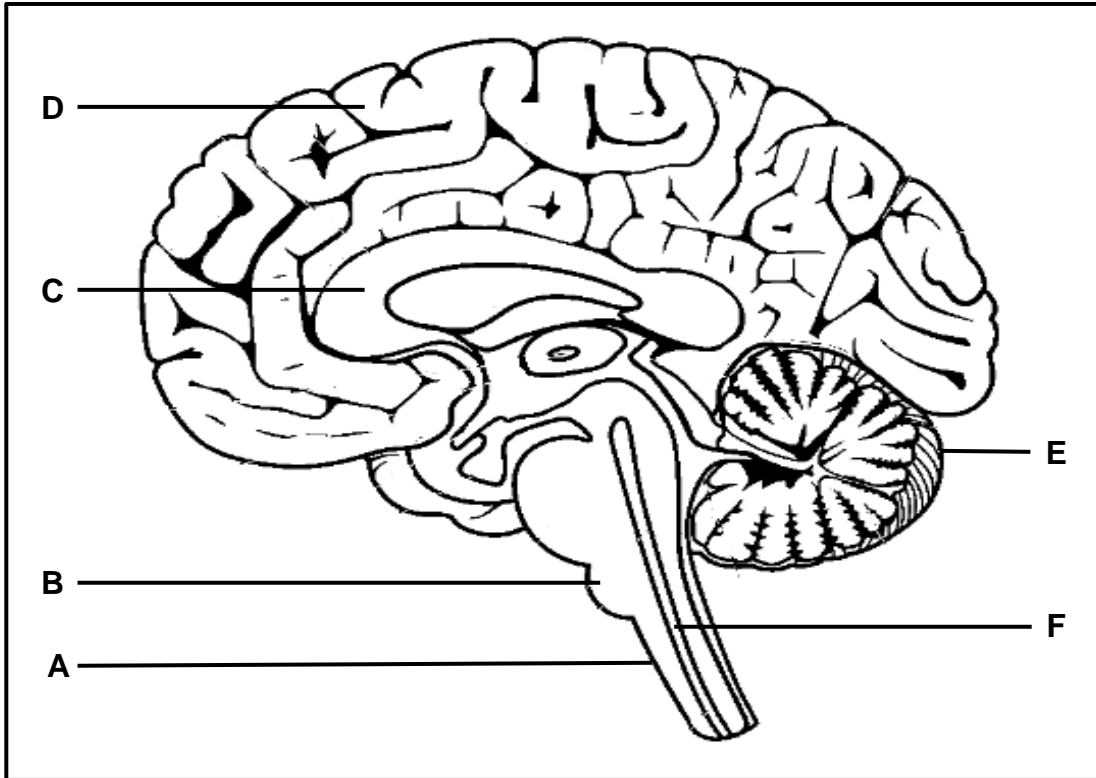

3.2.1 Hlwaya dikarolo tse ngotsweng:

- (a) **B** (1)
- (b) **C** (1)
- (c) **E** (1)

3.2.2 Fana ka mosebetsi o le mong wa:

- (a) Karolo e ngotsweng **A** (1)
- (b) Mokedikedi (fluid) o fumanwang ka hare ho karolo e ngotsweng **F** (1)

3.2.3 Haemorrhage (ho tswa madi a mangata ka baka la ho phahloha ha mothapo wa madi (excessive bleeding due to rupture of blood vessels) karolong e ngotsweng **D** e ka etsa hore e se ke ya sebetsa ka ho sa feleng.

- (a) Hlalosa lebaka la tshenyho ho karolo e ngotsweng **D**. (3)
- (b) Bolela ditlamorao tse tharo tsa tshenyho e boletsweng **POTSONG YA 3.2.3 (a)** ho mokudi. (3)

3.3 Teko e ile ya etswa ho fuputsa tataiso ya kholo ya lisele ha peo e melang e ne e bewa ka kotloloho ho clinostat e stationary (e emeng) jwalo ka ha ho bontsitswe setshwantsong se ka tlase. Melebela ya peo e melang ile ya pepeswa leseli ho tswa hohle. Pampiri e kolobisitsweng nako le nako e ne e fafatswa ka metsi ho boloka peo e le mongobo. Peo e ile ya bolokwa sebakeng sena ka matsatsi a mane. Ntlheng ya plumule e ile ya qala ho inama me ya hola ka mora matsatsi a mane.

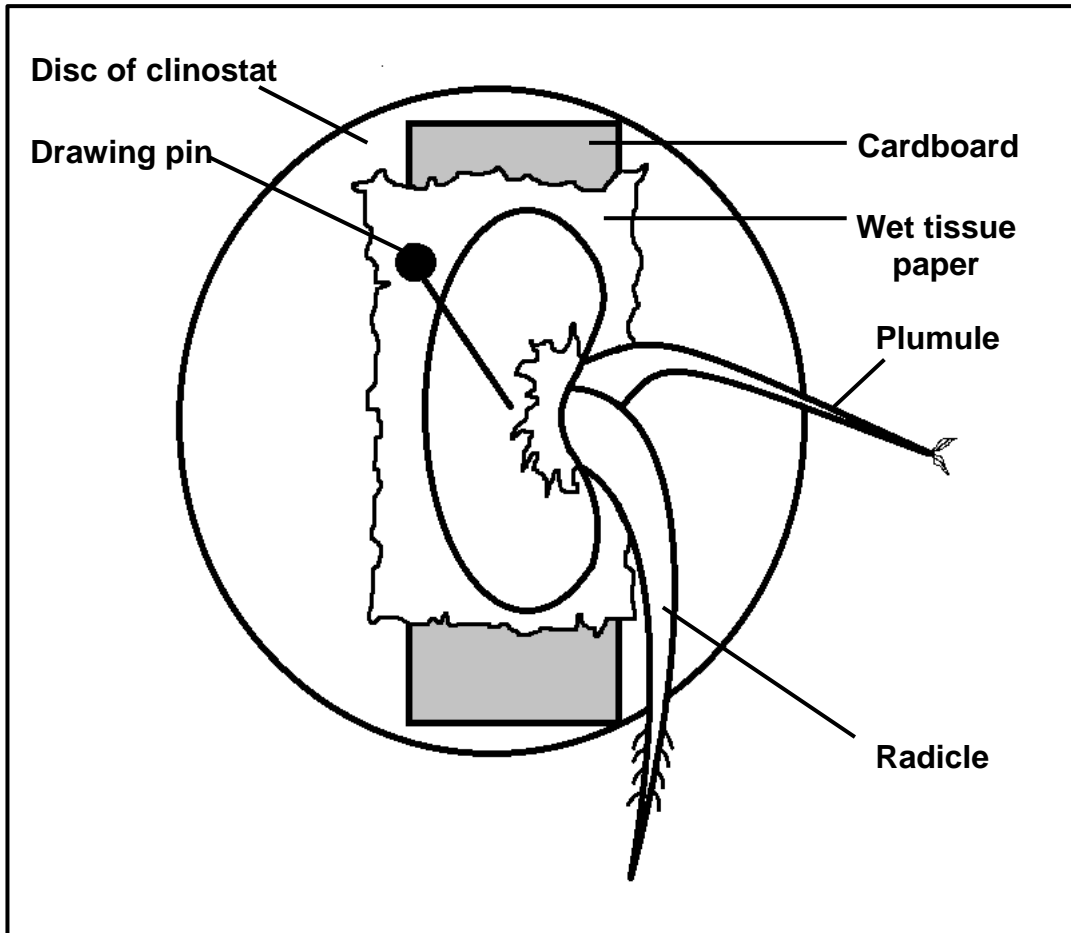

- 3.3.1 Fana ka hormone e laolang tsela yeo dijalo di holang ka yona. (1)
- 3.3.2 Bolela moo hormone e boletsweng POTSONG ya 3.3.1 e ka fumaneha teng. (1)
- 3.3.3 Fana ka lebaka la ho pepesa peo e holang ho khanya ho tswa mahlakoreng ohle. (1)
- 3.3.4 Hlalosa hore na kholo ya plumule e ya kae kamora matsatsi a mane. (4)
- 3.3.5 Taolo e efapana jwang le teko? (1)

3.4 Qotso e fanang ka leseli ka (scrotum) e fanwe ka tlase.

Scrotum ke mokotla o hlephileng wa letlalo (loose pouch-like sac) o leketlang ka morao ho botona (penis). O tshetsi le di testicles (tsewu hape di bitswang testes), hammoho le methapo kutlo le methapo ya mali e mengata. Scrotum se tshebetso ho sireletsang me se sebetsa e le mokhwa wa ho laola maemo a leholimo(climate) bakeng sa (testes). Bakeng sa kholofalo ya sperm e tlwaelehileng, di testes di tlameha ho ba motjhesong o bata hanyane ho feta motjheso wa mmele. Mesifa e khethehileng leboteng la scrotum e lumella hore di kenelle (ho tiisa) le ho phomola, e sisinya ditshwalesa (testes) haufi le mele bakeng sa mofuthu le tsireletso kapa hole le mele ho fokotsa mocheso.

[Ho tswa ho <https://my.clevelandclinic.org/health/articles/9117-male-reproductive-system>]

- 3.4.1 Ho tswa qotsong bolela mesebetsi e meli ya (scrotum). (2)
  - 3.4.2 Bolela sebopeliso seo di (sperms) diholang le ho ntsetswa pele ka teng. (1)
  - 3.4.3 Hlalosa ditlamarawu ho tswalo (human reproduction) haeba motho e motona a apara liaparo tsa ka hare tse tiisang haholo ka dinako tsohle. (3)
  - 3.4.4 Ke keletso e fe eo oka e fang bakhanni ba banna baranang sebaka sesitelele/hole hore ba fokotse phallo yabokhoni ba bona ba ho tswala (reproduce)? (1)
- [40]**

**MATSHWAO OHLE A KAROLO YA B: 80**



**KAROLO C****POTSO YA 4**

Monghali Nkosi o ne a qabeletswe ka phapusing e nang le mosi ya hotele e neng e tuka. Boemo bahae ba ho phefumoloha bo ile ha eketseha ha a ntse a kwahelwa ke mose o boima (thick) ho tloha mokatong oka tlase. O ile a khona ho roba fensetere mme a tlolela kante ho phapusi ya hae. O ile a wela holima moqomo wa matlakala o seterateng o khona hotsitsisa kelello (restore balance).

Hlalosa ketsahalo (process) ena e ileng ya etsa hore a eketsehe sekahla sa ho hema ha a ntse a pota-potilwe kemosi o boima. Hlalosa hape kamoo a ileng a khona ho khutlisa botsitso (balance) ha a fihla moqomong wa matlakala.

Dikahare: (17)

Mo aho: (3)

**[20]**

**HLOKOMELA:** Ha ho na matsowo a tla fanwa bakeng sa dikarabo ka mokhwa wa ditswantso tse tsamayang.

**MATSHWAO OHLE A KAROLO YA C: 20****MATSHWAO OHLE A PAMPIRI ENA: 150**