

SA's Leading Past Year

Exam Paper Portal

STUDY

You have Downloaded, yet Another Great Resource to assist you with your Studies 😊

Thank You for Supporting SA Exam Papers

Your Leading Past Year Exam Paper Resource Portal

Visit us @ [www.saexampapers.co.za](http://www.saexampapers.co.za)



SA EXAM  
PAPERS



PLEASE FOLLOW THESE INSTRUCTIONS CAREFULLY	VOLG ASSEBLIEF HIERDIE INSTRUKSIES NOUKEURIG
1. Clearly write your examination number and centre number in the space provided and attach your barcode label in the space provided.	1. <i>Skryf jou eksamennommer en sentrumnummer duidelik in die ruimtes verskaf en plak jou stafieskodeplakker in die ruimte verskaf.</i>
2. Remember that your own name (or the name of your school) may NOT appear anywhere on or in this answer book.	2. <i>Onthou dat jou eie naam (of die naam van jou skool) NIE op of in hierdie antwoordeboek mag voorkom NIE.</i>
3. Answer ALL questions in the spaces provided.	3. <i>Beantwoord ALLE vrae in die ruimtes wat verskaf is.</i>
4. NO pages may be torn from this answer book.	4. <i>GEEN bladsye mag uit hierdie antwoordeboek geskeur word NIE.</i>
5. Read the instructions printed on your timetable carefully as well as any other instructions which may be given in each question paper.	5. <i>Lees die instruksies, wat op jou eksamenrooster gedruk is, sorgvuldig deur, asook enige ander instruksies wat op elke vraestel gegee word.</i>
6. Candidates may NOT retain an answer book or remove it from the examination room.	6. <i>GEEN antwoordeboek mag deur die kandidaat behou of uit die eksamenlokaal verwyder word NIE.</i>
7. Answers must be written in black/blue ink as distinctly as possible. Do NOT write in the margins.	7. <i>Skryf die antwoorde so duidelik moontlik met swart/blou ink. Laat die kantlyne oop.</i>
8. Write the numbers of the questions you have answered on the front cover of the answer book where marks are to be recorded.	8. <i>Skryf die nommers van die vrae wat jy beantwoord het op die voorblad van die antwoordeboek waar die punte aangebring word.</i>
9. If you require additional space for your answers: 9.1 Use the additional space provided at the end of the answer book. 9.2 When answering a question in the additional space, clearly indicate the question number in the column on the LHS. 9.3 Rule off after each answer.	9. <i>In geval jy bykomende ruimte benodig vir jou antwoorde:</i> 9.1 <i>Gebruik die bykomende ruimte wat aan die einde van die antwoordeboek verskaf word.</i> 9.2 <i>As 'n vraag in die bykomende ruimte beantwoord word, dui duidelik die vraagnommer in die kolom aan die LK aan.</i> 9.3 <i>Trek 'n lyn na elke antwoord.</i>
10. Draw a neat line through any work/rough work that must not be marked.	10. <i>Trek 'n netjiese lyn deur enige werk/rofwerk wat nie nagesien moet word nie.</i>



**QUESTION/VRAAG 1**

<b>Temperature/Temperatuur (in °C)</b>	14	24	26	18	20	28	22	15	12	19
<b>Number of hot drinks sold/Aantal warm drankies verkoop</b>	410	258	192	324	328	156	280	384	230	280

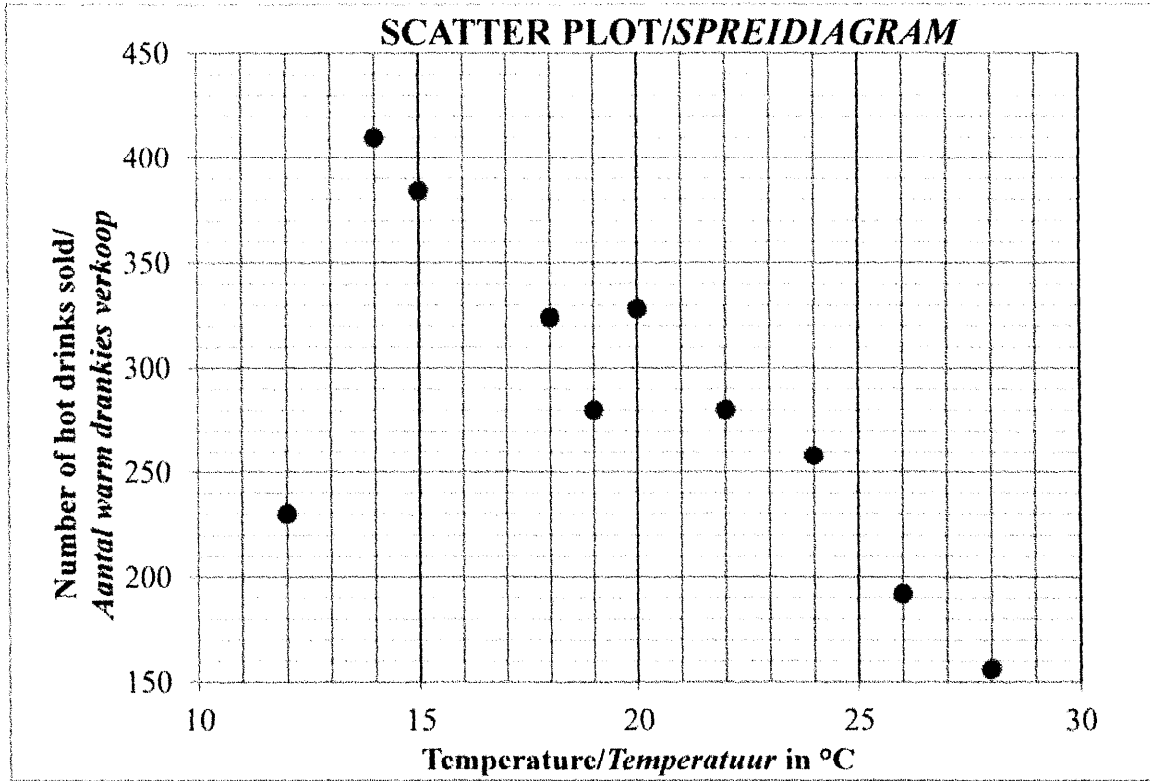

	<b>Solution/Oplissing</b>	<b>Marks/Punte</b>
1.1		(1)
1.2		(3)
1.3		(3)
1.4		(1)
		<b>[8]</b>



**QUESTION/VRAAG 2**

2.1

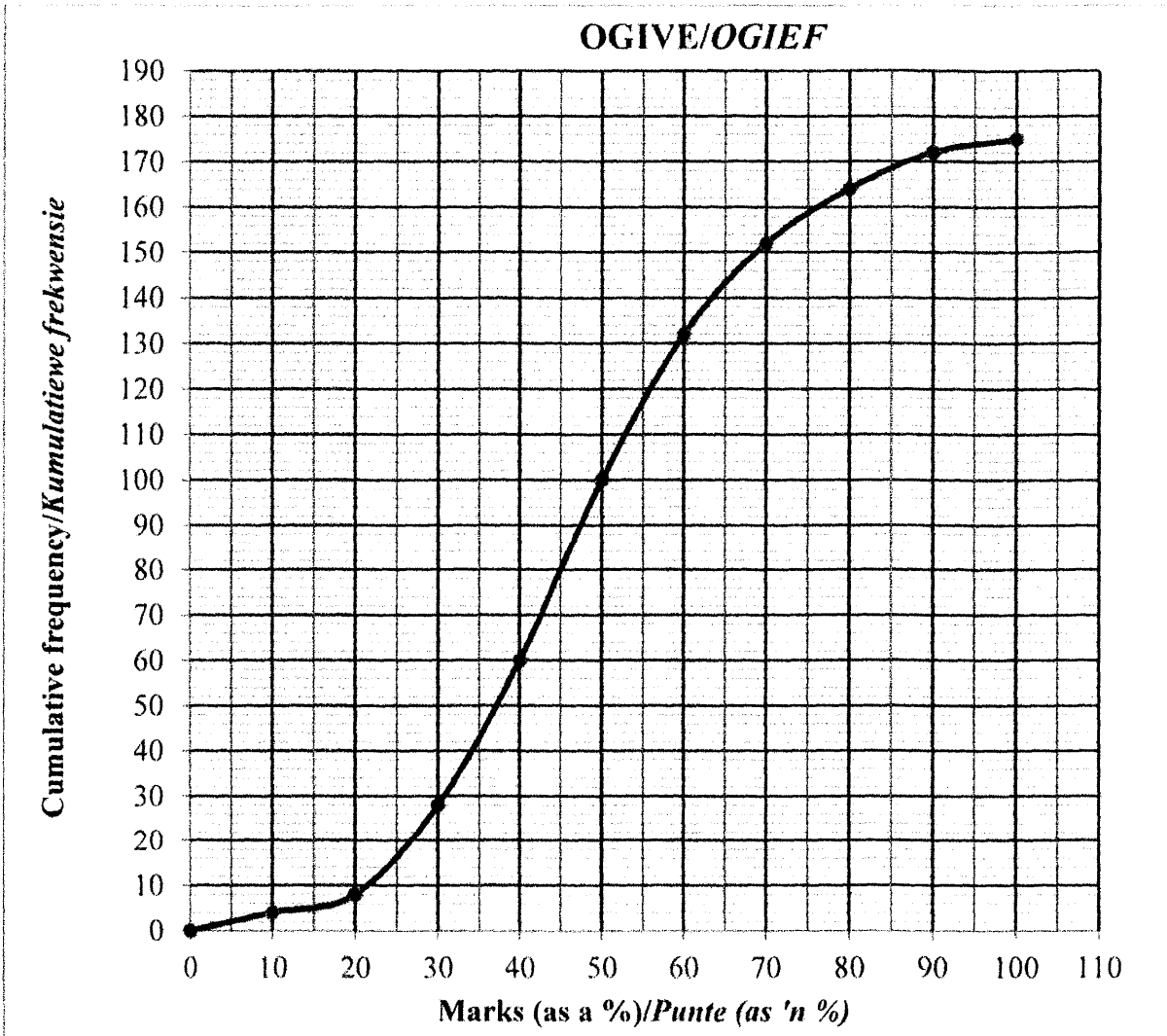

	<b>Solution/Oplissing</b>	<b>Marks Punte</b>
2.1.1		(1)
2.1.2		(1)
2.1.3		(2)



2.2

<b>Marks (as a %)</b> <b>Punte (as 'n %)</b>	62	58	78	85	74	48	74	84	100	46	80	92	60	90	92
---	----	----	----	----	----	----	----	----	-----	----	----	----	----	----	----

	<b>Solution/Oplossing</b>	<b>Marks Punte</b>
2.2.1		(2)
2.2.2		(1)
2.2.3		(2)
2.3		(3)
		[12]



**QUESTION/VRAAG 3**

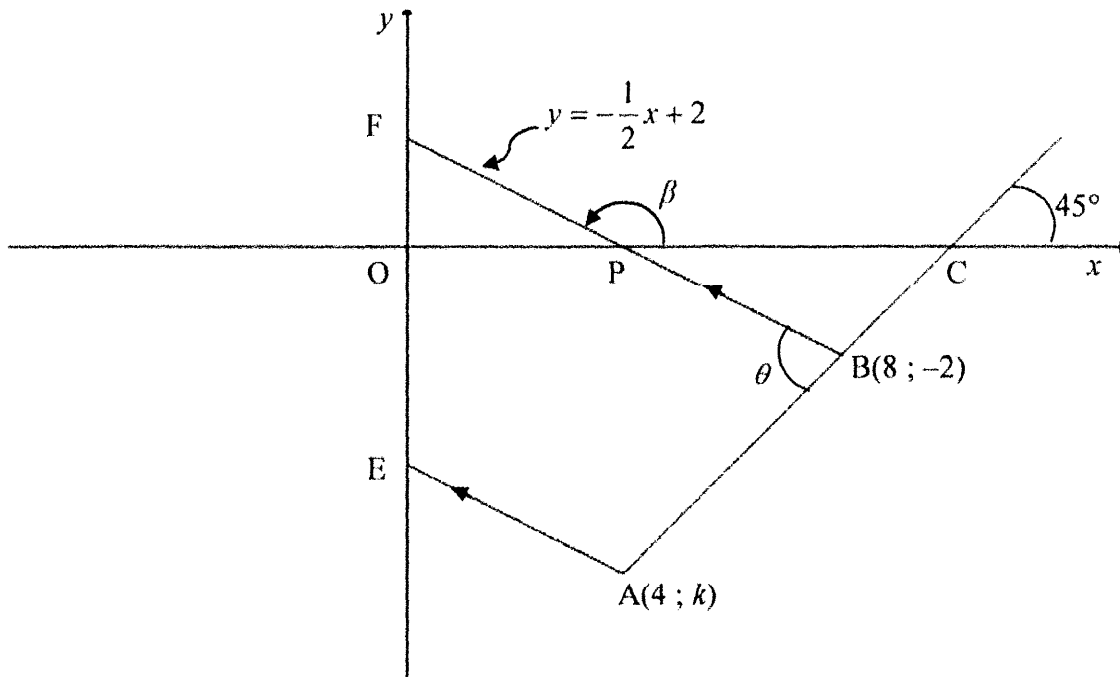

	<b>Solution/Oplissing</b>	<b>Marks Punte</b>
3.1		(1)
3.2		(2)
3.3		(3)



	<b>Solution/Oplissing</b>	<b>Marks Punte</b>
3.4.1		(3)
3.4.2		(3)
3.4.3		(4)
3.5		(4)
		<b>[20]</b>





**QUESTION/VRAAG 4**

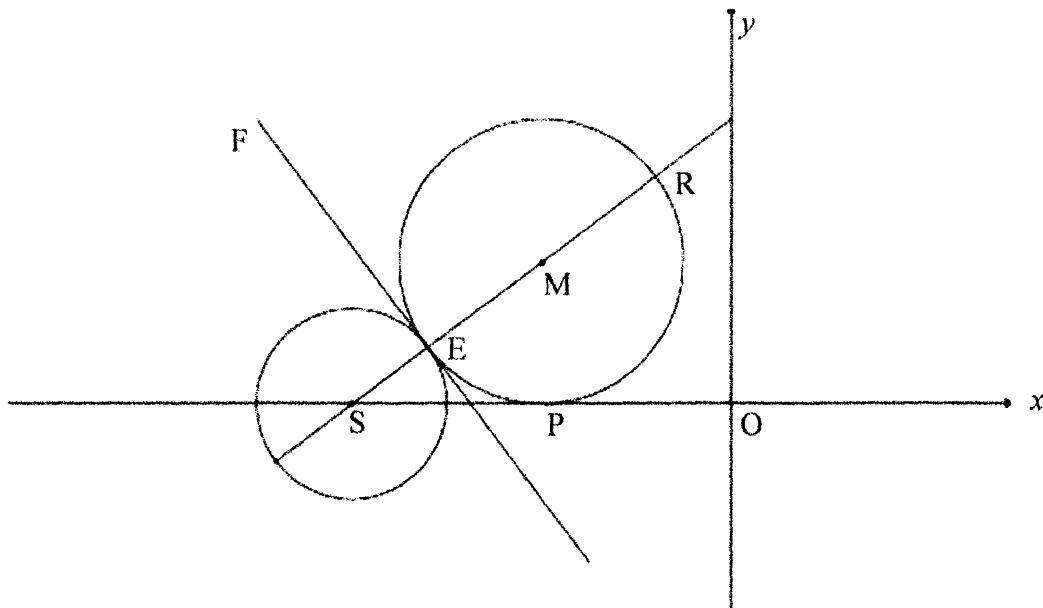

	<b>Solution/Oplossing</b>	<b>Marks Punte</b>
4.1.1		(2)
4.1.2		(1)
4.2.1		(2)
4.2.2		



	<b>Solution/Oplissing</b>	<b>Marks Punte</b>
4.2.2 (cont./ verv.)		(3)
4.2.3		(4)
4.2.4		(2)
4.3		(5)
		<b>[19]</b>



**QUESTION/VRAAG 5**

5.1

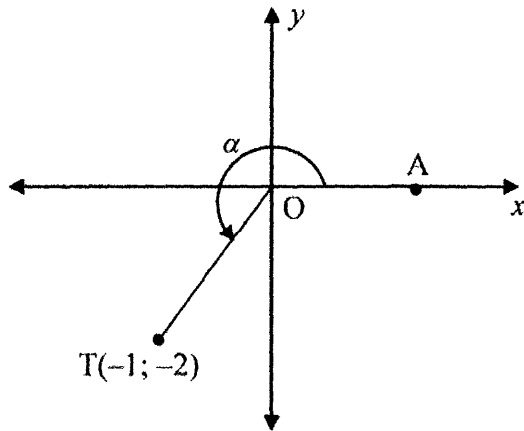

	<b>Solution/Oplissing</b>	<b>Marks Punte</b>
5.1.1		(1)
5.1.2		(2)
5.1.3		(4)



	<b>Solution/Oplossing</b>	<b>Marks Punte</b>
5.2		(4)
5.3.1		(4)
5.3.2		(2)
5.4		



	<b>Solution/Oplissing</b>	<b>Marks Punte</b>
5.4 (cont./ verv.)		
5.5		(5)
		(5)
		<b>[27]</b>



**QUESTION/VRAAG 6**

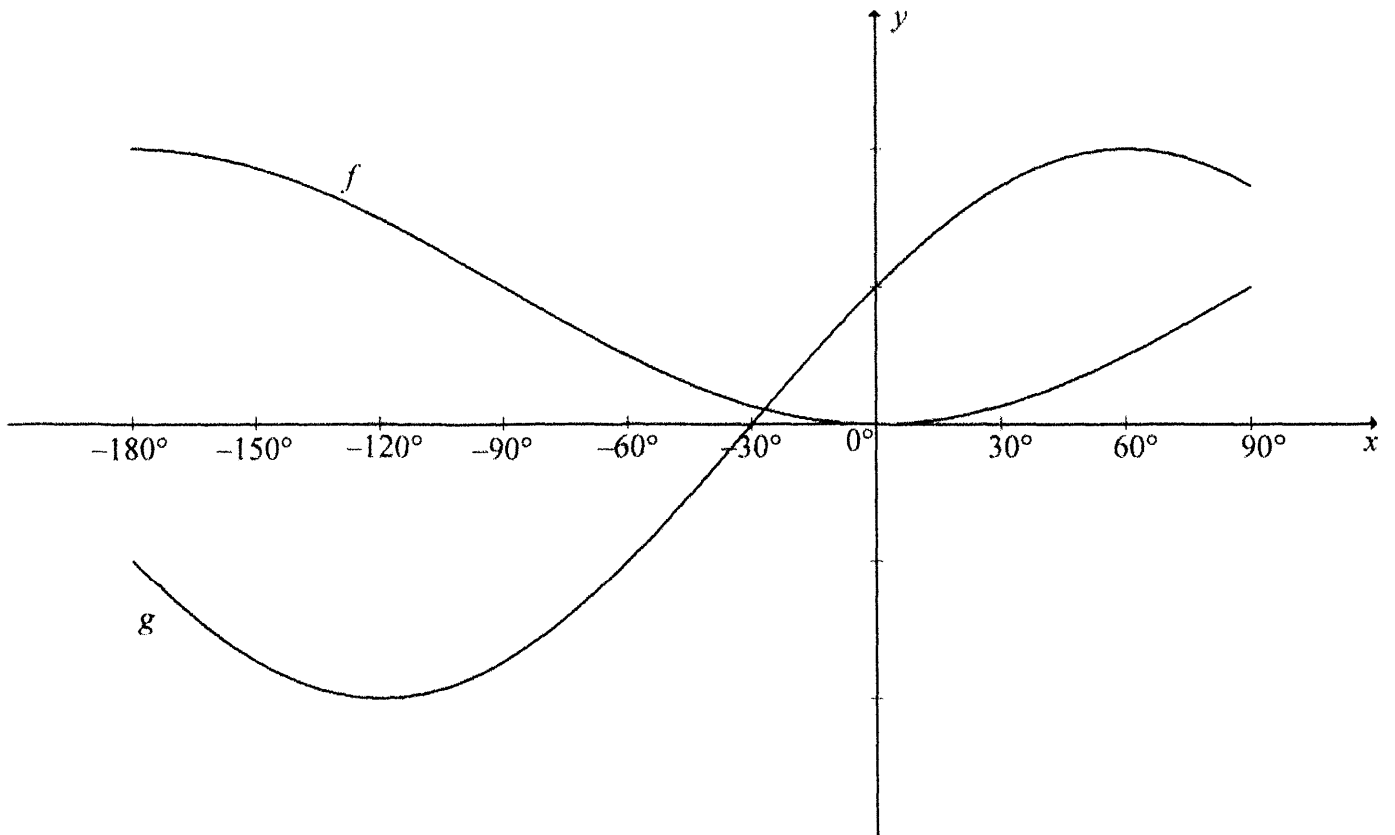

	<b>Solution/Oplissing</b>	<b>Marks Punte</b>
6.1.1		(2)
6.1.2		(2)
6.2		(2)
		<b>[6]</b>



**QUESTION/VRAAG 7**

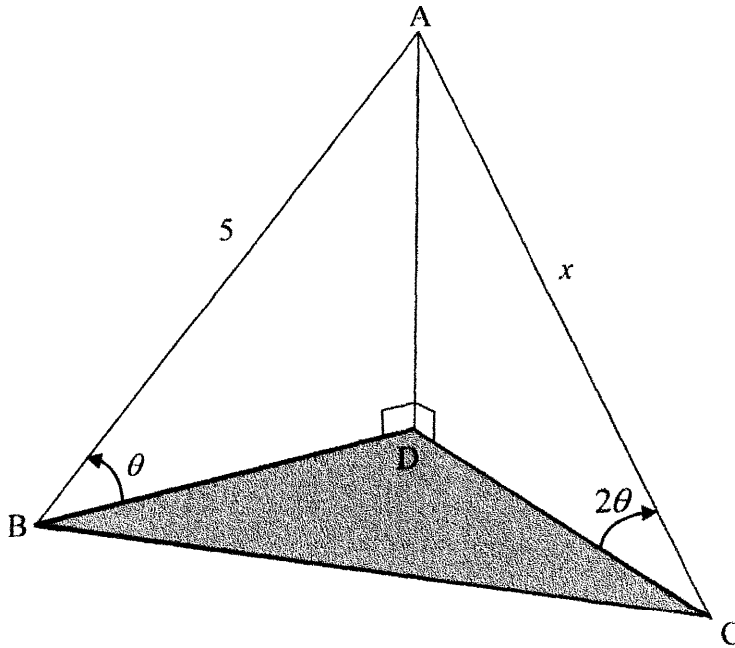

	<b>Solution/Oplissing</b>	<b>Marks Punte</b>
7.1		(5)
7.2		(3)
		<b>[8]</b>



Give reasons for your statements in QUESTIONS 8, 9 and 10.  
Verskaf redes vir jou bewerings in VRAAG 8, 9 en 10.

**QUESTION/VRAAG 8**

8.1

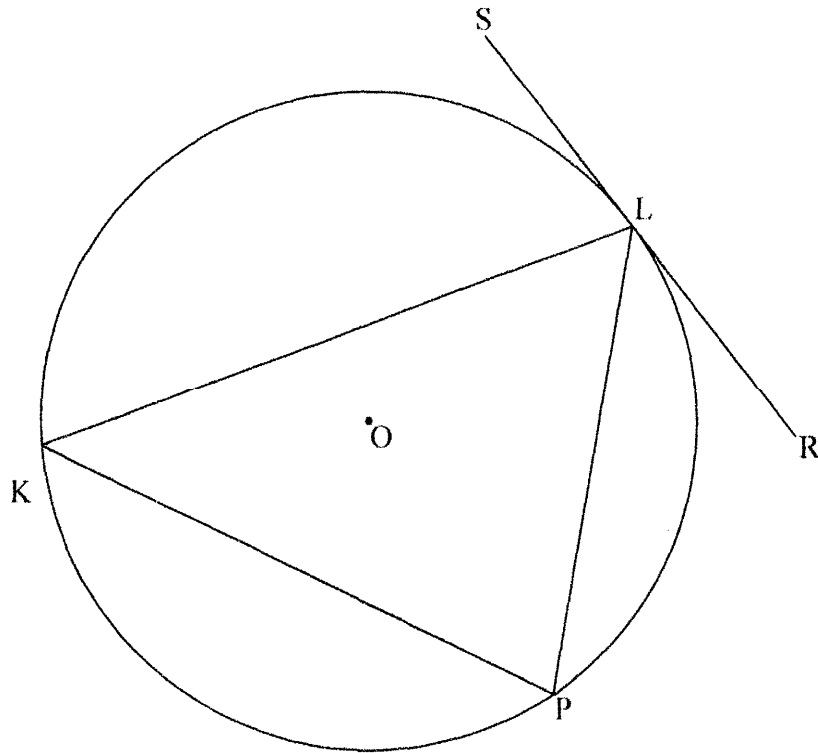

	<b>Solution/Oplossing</b>	<b>Marks Punte</b>
		<b>(6)</b>





8.2

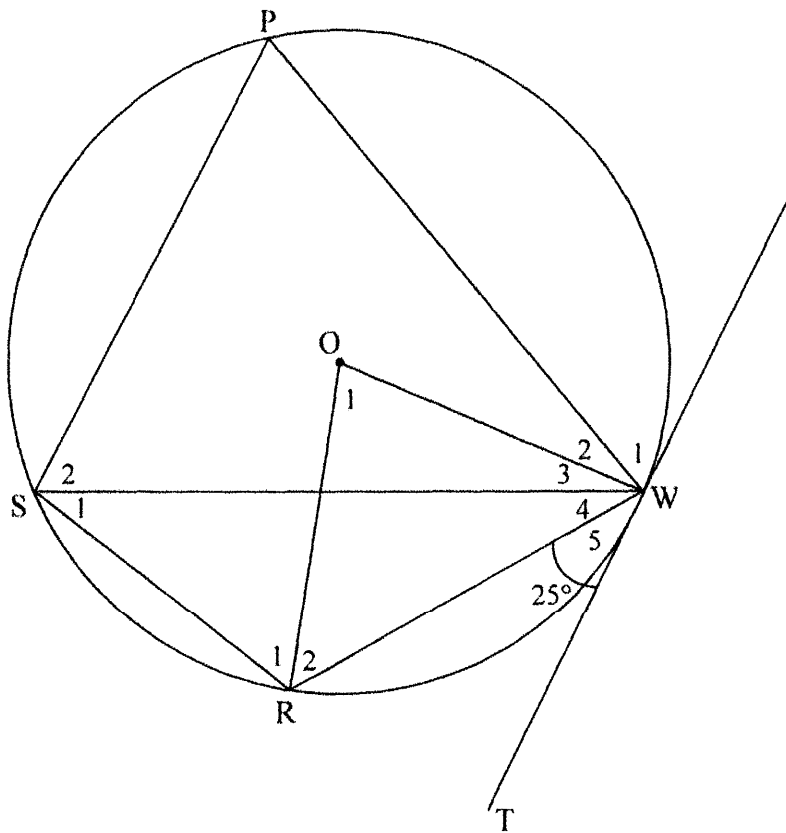

	<b>Solution/Oplossing</b>	<b>Marks Punte</b>
8.2.1(a)		(2)
8.2.1(b)		(2)



	<b>Solution/Oplissing</b>	<b>Marks Punte</b>
8.2.1(c)		(5)
8.2.2		(3)



8.3

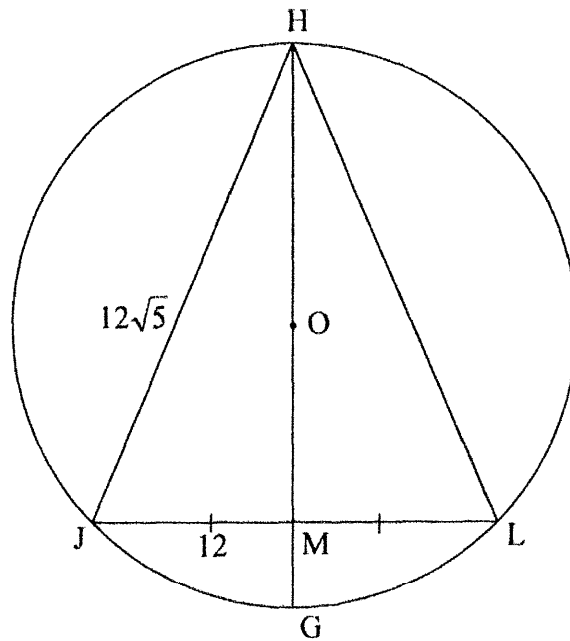

	<b>Solution/Oplossing</b>	<b>Marks Punte</b>
8.3.1		(2)
8.3.2		(5)
		<b>[25]</b>



**QUESTION/VRAAG 9**

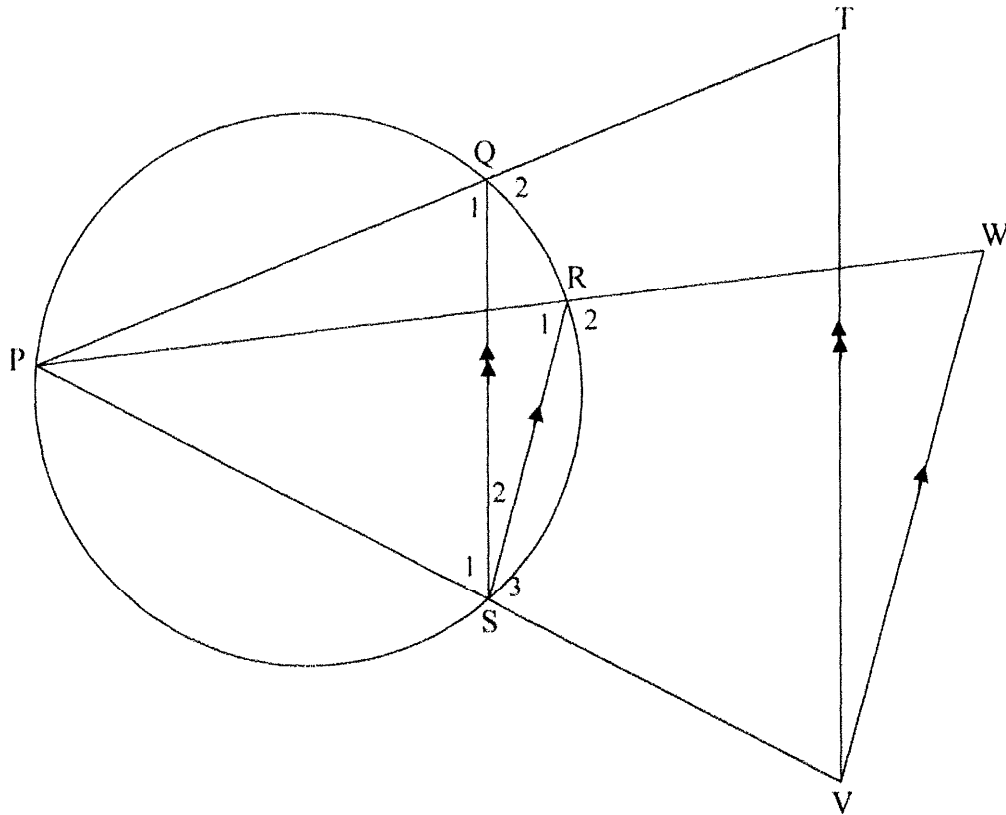

	<b>Solution/Oplissing</b>	<b>Marks Punte</b>
9.1		(3)
9.2		(5)
		<b>[8]</b>



**QUESTION/VRAAG 10**

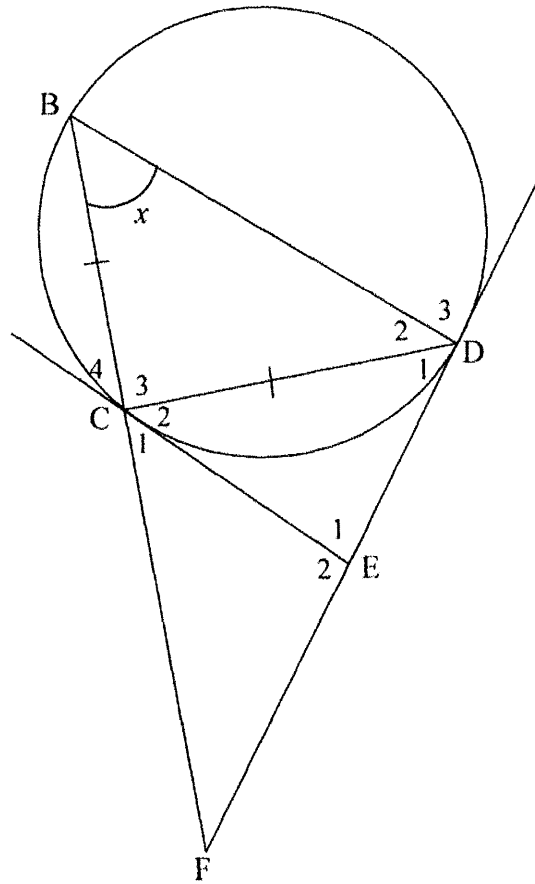

	<b>Solution/Oplissing</b>	<b>Marks Punte</b>
10.1.1		(5)
10.1.2		(3)



	<b>Solution/Oplossing</b>	<b>Marks Punte</b>
10.2.1	<div style="border: 1px solid black; height: 100%; width: 100%;"></div>	(3)
10.2.2	<div style="border: 1px solid black; height: 100%; width: 100%;"></div>	(6)
		[17]









