

SA's Leading Past Year

Exam Paper Portal

STUDY

You have Downloaded, yet Another Great Resource to assist you with your Studies 😊

Thank You for Supporting SA Exam Papers

Your Leading Past Year Exam Paper Resource Portal

Visit us @ www.saexampapers.co.za



SA EXAM
PAPERS



basic education

Department:
Basic Education
REPUBLIC OF SOUTH AFRICA

Candidate Barcode Label/Stafieskodeplakker

SC/NSC Answer Book
SS/NSS-Antwoordeboek

SENIOR CERTIFICATE EXAMINATIONS/NATIONAL SENIOR CERTIFICATE EXAMINATIONS
SENIOR SERTIFIKAAT-EKSAMEN/NASIONALE SENIORSERTIFIKAAT-EKSAMEN (Grade 12/Graad 12)

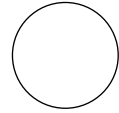

Sequence No. on mark sheet
Volgnommer op puntestaat

CENTRE NUMBER SENTRUMNOMMER															
--------------------------------	--	--	--	--	--	--	--	--	--	--	--	--	--	--	--

EXAMINATION NUMBER EKSAMENNOMMER																
-------------------------------------	--	--	--	--	--	--	--	--	--	--	--	--	--	--	--	--

DATE DATUM																
---------------	--	--	--	--	--	--	--	--	--	--	--	--	--	--	--	--

BOOK NUMBER BOEKNOMMER									OF VAN								BOOKS BOEKE
---------------------------	--	--	--	--	--	--	--	--	-----------	--	--	--	--	--	--	--	----------------

SUBJECT CODE VAKKODE																
-------------------------	--	--	--	--	--	--	--	--	--	--	--	--	--	--	--	--

PAPER NUMBER VRAESTELNOMMER																	2
--------------------------------	--	--	--	--	--	--	--	--	--	--	--	--	--	--	--	--	---

SUBJECT NAME VAKNAAM																		TECHNICAL MATHEMATICS/TEGNIESE WISKUNDE
-------------------------	--	--	--	--	--	--	--	--	--	--	--	--	--	--	--	--	--	--

This answer book consists of 23 pages./Hierdie antwoordeboek bestaan uit 23 bladsye.

MARKER/NASIENER				MODERATOR'S INITIALS IN RELEVANT BLOCK/ MODERATORPARAAF IN BETROKKE BLOKKIE					
Question Vraag	Marks Punte	Marker's Code & Initials		Marks Punte	SM	DCM	CM	IM	EM
1									
2									
3									
4									
5									
6									
7									
8									
9									
10									
11									
12									
13									
14									
15									
16									

RE-MARK/RE-CHECK/ HERNASIEN/HERKONTROLEER		
Question Vraag	Marks Punte	Initials Paraaf
1		
2		
3		
4		
5		
6		
7		
8		
9		
10		
11		
12		
13		
14		
15		
16		

																		TOTAL TOTAAL	

																		TOTAL TOTAAL
																		HASH TOTAL KAFTOTAAL

CONTROLLED AND CERTIFIED CORRECT SURNAME AND INITIALS OF EA																		
--	--	--	--	--	--	--	--	--	--	--	--	--	--	--	--	--	--	--

PLEASE READ INSTRUCTIONS ON THE NEXT PAGE
LEES ASSEBLIEF INSTRUKSIES OP VOLGENDE BLADSY



PLEASE FOLLOW THESE INSTRUCTIONS CAREFULLY	VOLG ASSEBLIEF HIERDIE INSTRUKSIES NOUKEURIG
<p>1. Your examination number and centre number must be clearly written in the space provided and attach your examination number sticker in the space provided.</p>	<p>1. Skryf jou eksamennommer en sentrumnommer duidelik in die ruimtes verskaf en plak jou eksamennommeretiket in die ruimte verskaf.</p>
<p>2. Remember that your own name (or the name of your school) may not appear anywhere on or in this answer book.</p>	<p>2. Onthou dat jou eie naam (of die naam van jou skool) nie op of in hierdie antwoordeboek mag voorkom nie.</p>
<p>3. Answer ALL questions in the spaces provided.</p>	<p>3. Beantwoord ALLE vrae in die ruimtes wat verskaf is.</p>
<p>4. No pages may be torn from this answer book.</p>	<p>4. Geen bladsye mag uit hierdie antwoordeboek geskeur word nie.</p>
<p>5. Read the instructions printed on your timetable carefully as well as any other instructions which may be given in each examination paper.</p>	<p>5. Lees die instruksies wat op jou eksamenrooster gedruk is sorgvuldig deur, asook enige ander instruksies wat in elke eksamenvraestel gegee word.</p>
<p>6. Candidates may not retain an answer book or remove it from the examination room. Answer books must be returned to the Invigilator at the end of the examination session.</p>	<p>6. Geen antwoordeboek mag deur die kandidaat behou of uit die eksamenlokaal verwyder word nie. Antwoordeboeke moet aan die einde van die eksamensessie aan die toesighouer terugbesorg word.</p>
<p>7. Answers must be written in black/blue ink as distinctly as possible. Do NOT write in the margins.</p>	<p>7. Skryf die antwoorde so duidelik moontlik met swart/blou ink. MOENIE in die kantlyn skryf NIE.</p>
<p>8. Indicate the questions you have answered by drawing a circle around the relevant numbers on the front cover of the answer book where marks are to be recorded.</p>	<p>8. Dui die vrae wat jy beantwoord het op die voorblad van die antwoordeboek aan, waar die punte aangebring word, deur 'n kringetjie om die nommers van die vrae wat jy beantwoord het, te trek.</p>
<p>9. Draw a line through any work/rough work that must not be marked.</p>	<p>9. Trek 'n netjiese lyn deur enige werk/rofwerk wat nie nagesien moet word nie.</p>
<p>10. In the event that you use the additional space provided: 10.1 Write down the question number question 10.2 Leave a line and rule off after your answer.</p>	<p>10. In geval jy die bykomende ruimte wat verskaf is, gebruik: 10.1 Skryf die vraagnommer neer 10.2 Laat 'n lyn oop en trek 'n lyn na jou antwoord.</p>



QUESTION/VRAAG 1

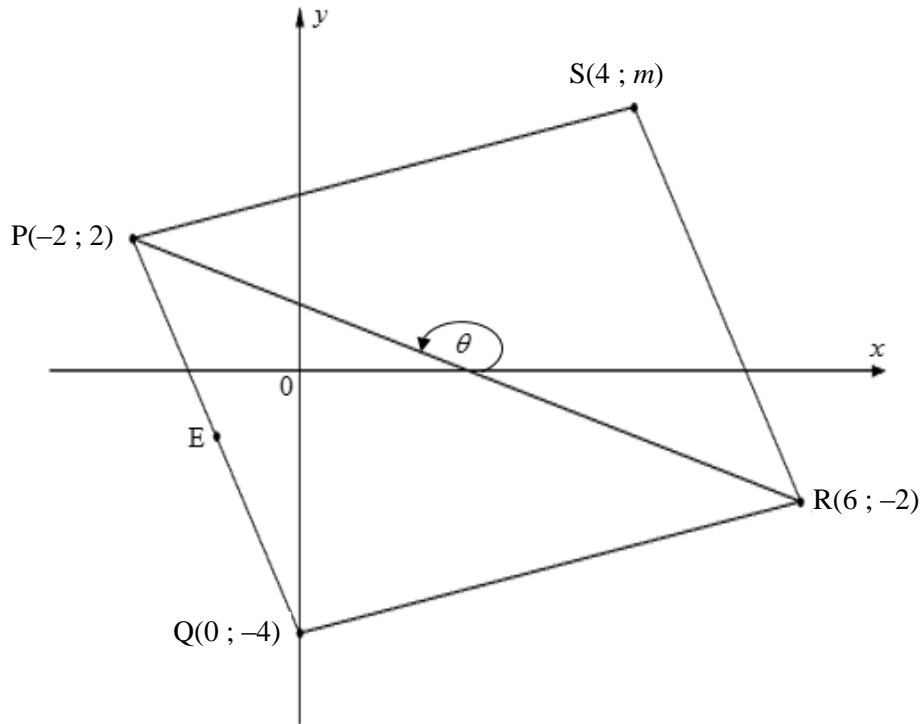

	Solution/Oplissing	Marks Punte
1.1.1		(2)
1.1.2		(3)
1.1.3		(2)



	Solution/Oplissing	Marks Punte
1.1.4		(2)
1.1.5		(4)
1.1.6		(2)
1.2		(2)
		[17]



QUESTION/VRAAG 2

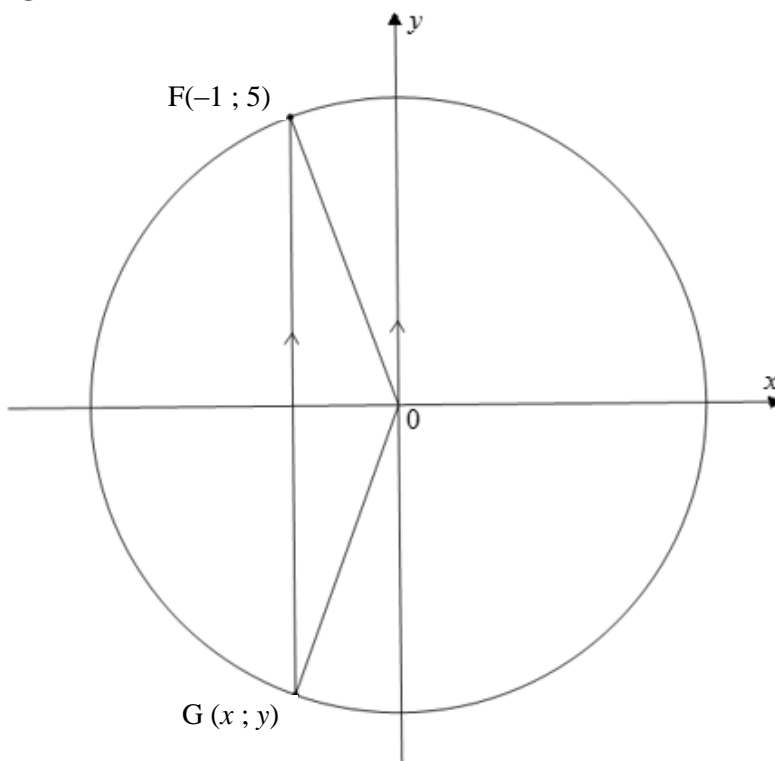

	Solution/Oplissing	Marks Punte
2.1.1		(2)
2.1.2(a)		(1)
2.1.2(b)		(3)

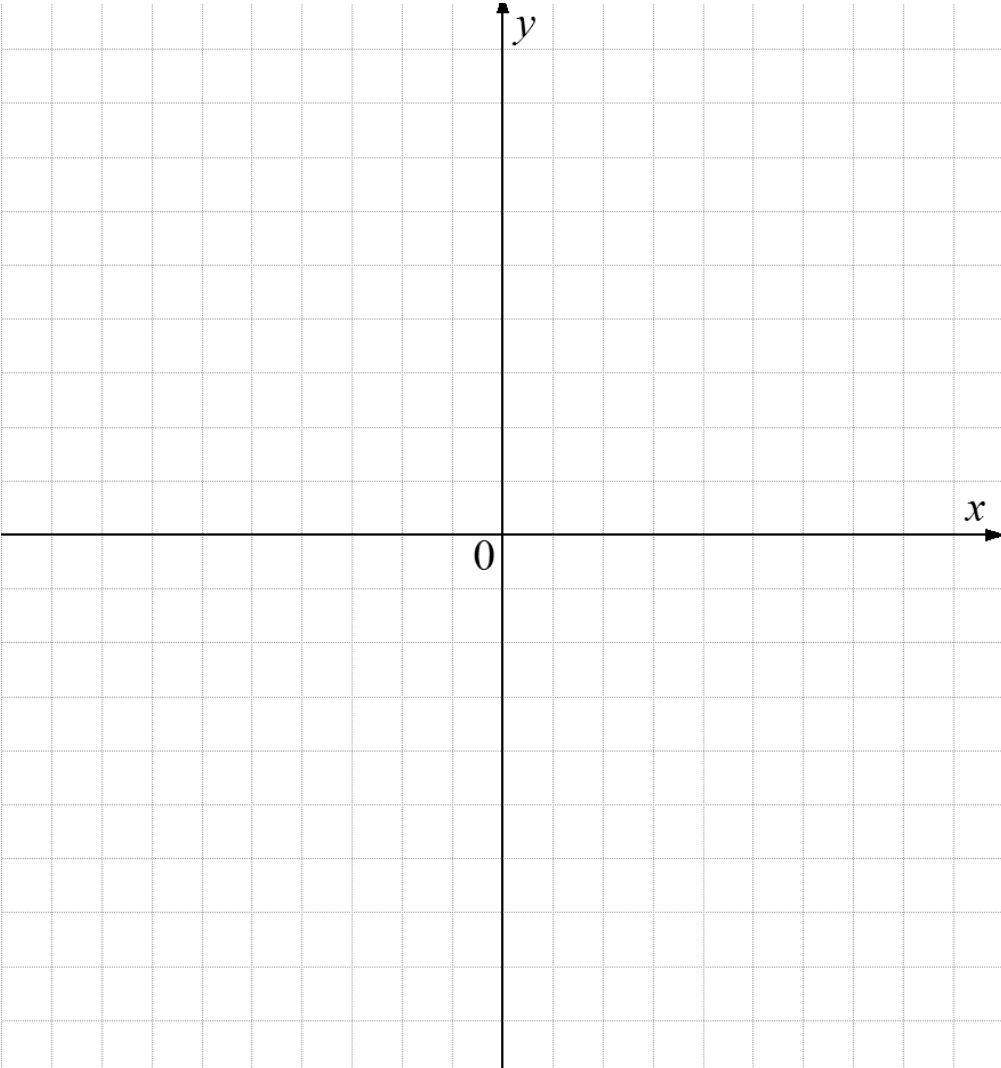

	Solution/Oplossing	Marks Punte
2.2		
		(3) [9]



QUESTION/VRAAG 3

	Solution/Oplossing	Marks Punte
3.1.1		(3)
3.1.2		(3)
3.2		(7)



3.3		
		[18]



QUESTION/VRAAG 4

	Solution/Oplissing	Marks Punte
4.1		
4.2		
		[13]

(4)

(9)

[13]

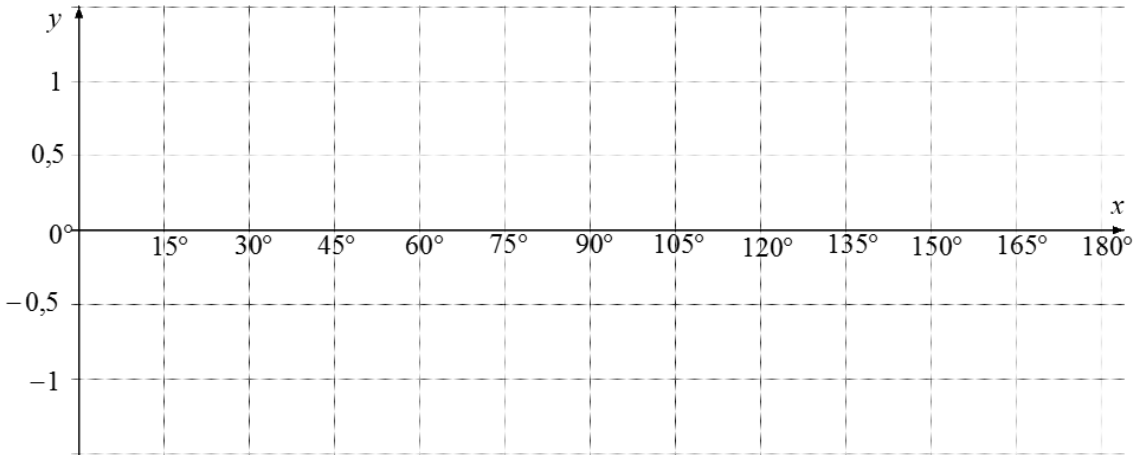

QUESTION/VRAAG 5

	Solution/Oplissing	Marks Punte
5.1		(1)
5.2		(6)
		[7]

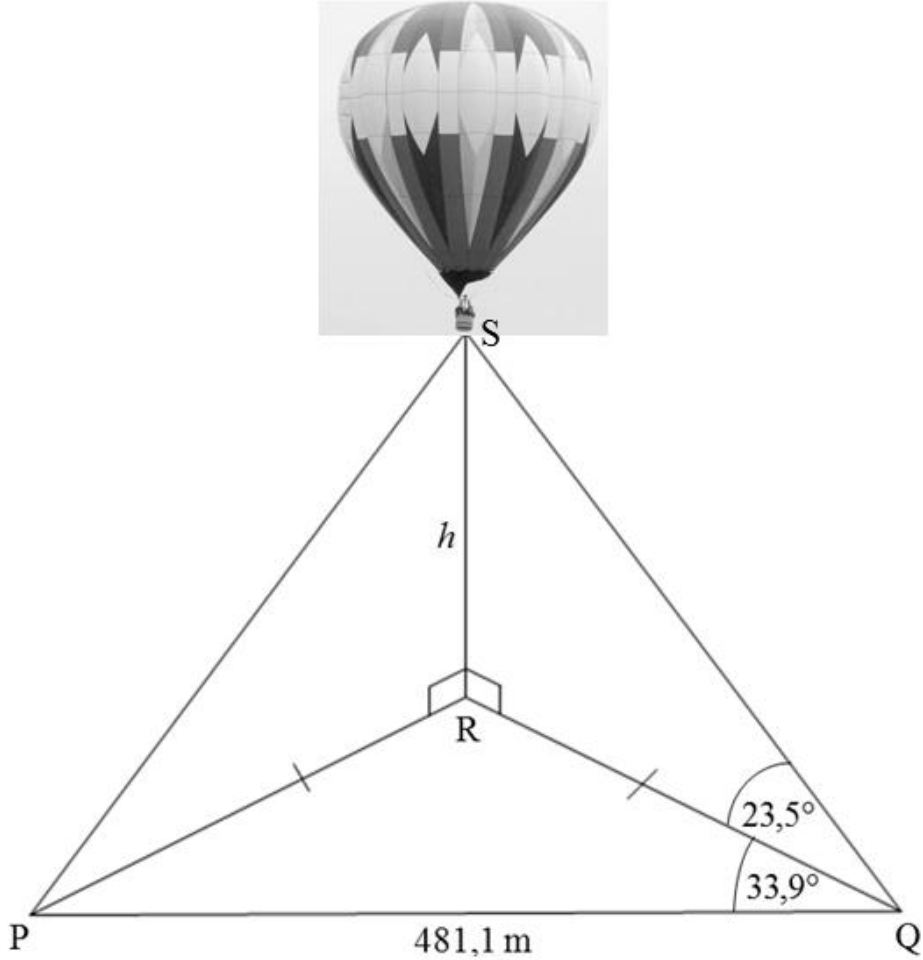

QUESTION/VRAAG 6

	<p>Solution/Oplissing</p> 	<p>Marks Punte</p>
<p>6.1</p>	<p>_____</p> <p>_____</p> <p>_____</p> <p>_____</p> <p>_____</p> <p>_____</p>	<p>(2)</p>
<p>6.2</p>	<p>_____</p> <p>_____</p> <p>_____</p> <p>_____</p> <p>_____</p> <p>_____</p>	<p>(3)</p>



6.3		(3)
6.4		(2)
	[10]	



Give reasons for your statements in QUESTIONS 7, 8 and 9.
Verskaf redes vir jou bewerings in VRAAG 7, 8 en 9.

QUESTION/VRAAG 7

	Solution/Oplossing	Marks Punte
7.1		(1)

7.2

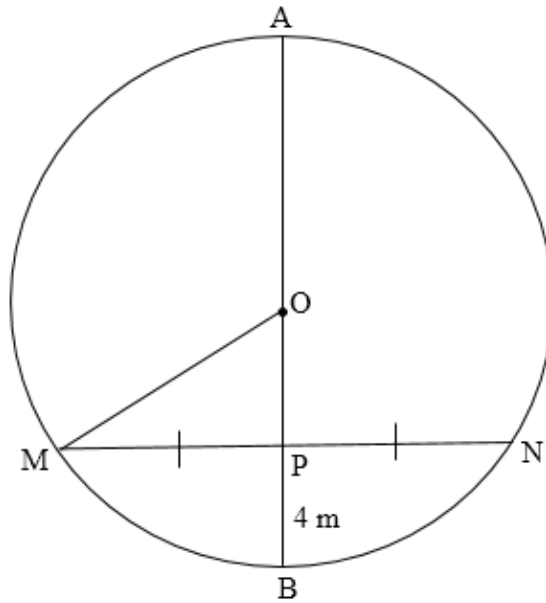

	Solution/Oplossing	Marks Punte
7.2.1		(1)
7.2.2		(5)
		[7]



QUESTION/VRAAG 8

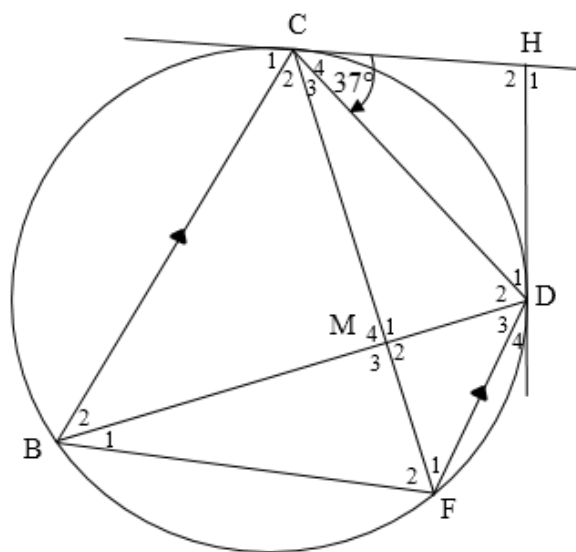

	Solution/Oplissing	Marks Punte
8.1		(4)
8.2		(4)
8.3		(3)
8.4		(4)
		[15]



QUESTION/VRAAG 9

	Solution/Oplissing	Marks Punte
9.1		(1)

9.2

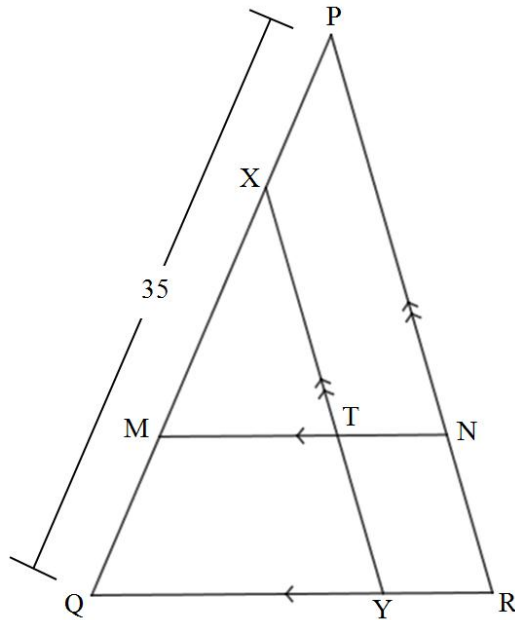

	Solution/Oplissing	Marks Punte
9.2.1		(4)
9.2.2		(5)



9.3

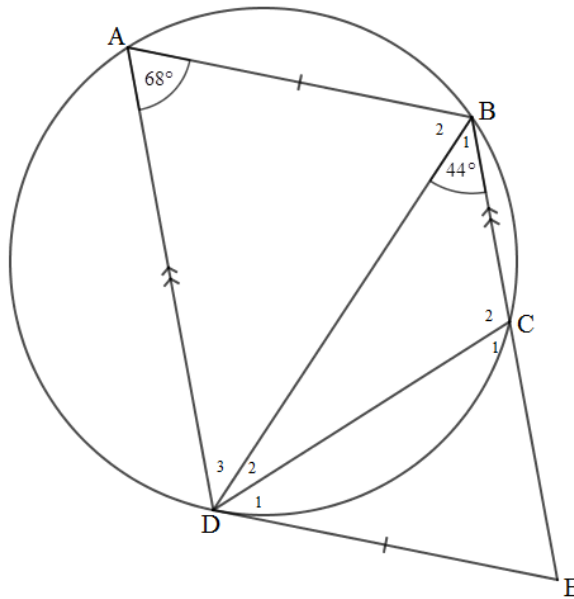

	Solution/Oplissing	Marks Punte
9.3.1		(4)
9.3.2		(2)
9.3.3		(3)
		[19]



QUESTION/VRAAG 10

10.1

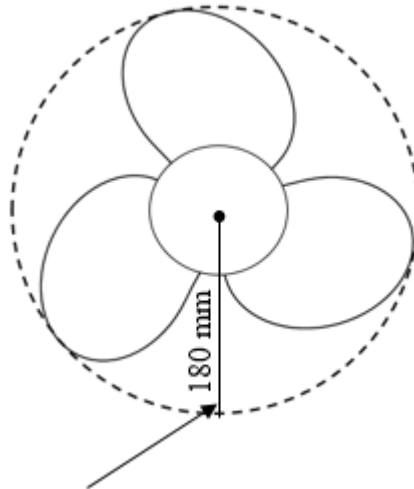

Radius of the circular path formed
 by the rotating propeller blades/
*Radius van die sirkelpad gevorm
 deur die roterende skroefblaaie*

	Solution/Oplissing	Marks Punte
10.1.1		(2)
10.1.2		(4)



10.2

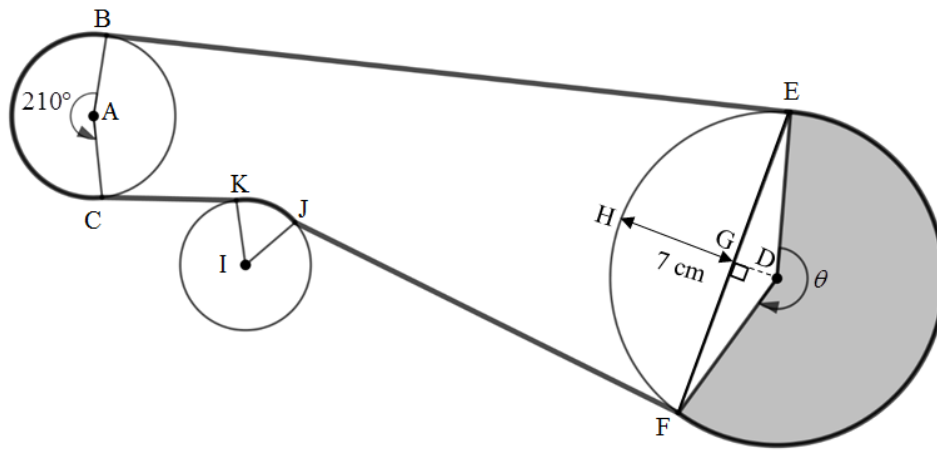

	Solution/Oplissing	Marks Punte
10.2.1		(1)
10.2.2		(3)
10.2.3		(3)
10.2.4		(3)



	Solution/Oplissing	Marks Punte
10.2.5		
		(5)
		[21]



QUESTION/VRAAG 11

11.1

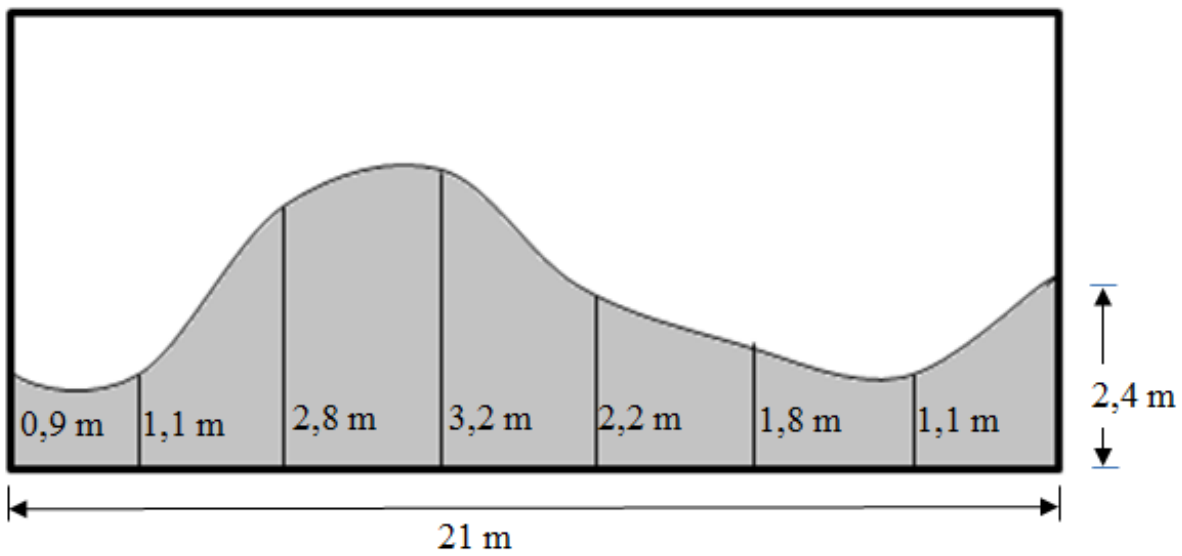

	Solution/Oplissing	Marks Punte
11.1.1		(4)
11.1.2		(2)



11.2

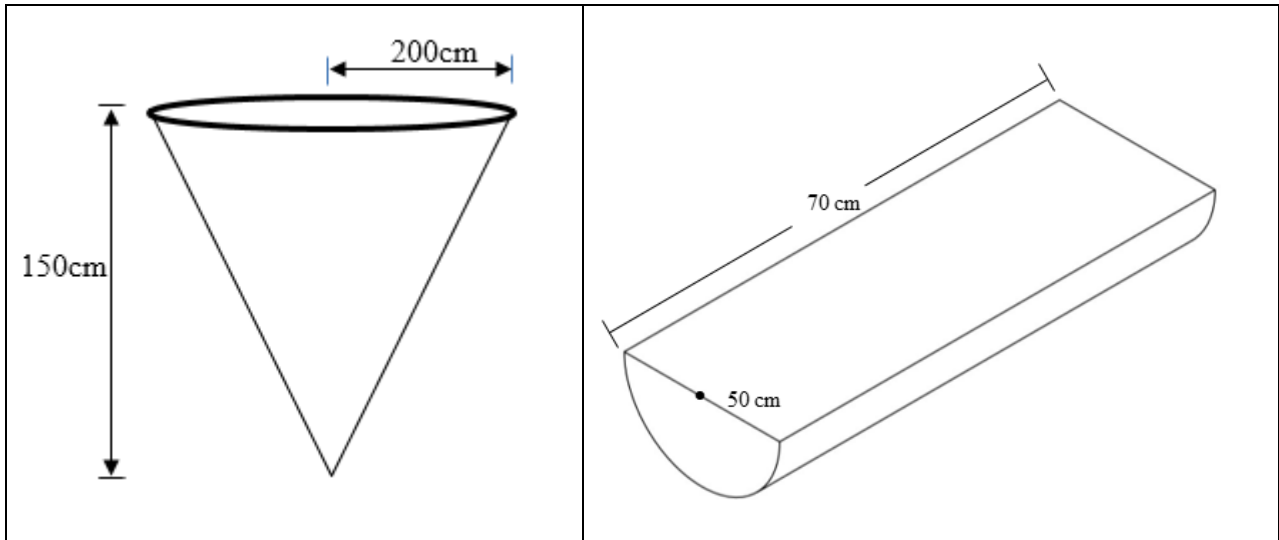

The following formulae may be used/Die volgende formules kan gebruik word:

Surface area of a cone = $\pi r s + \pi r^2$	Buite-oppervlakte van 'n keël = $\pi r s + \pi r^2$
Total surface area of a cylinder = $2\pi r^2 + 2\pi r h$	Totale buite-oppervlakte van 'n silinder = $2\pi r^2 + 2\pi r h$
Volume of a cone = $\frac{1}{3}\pi r^2 h$	Volume van 'n keël = $\frac{1}{3}\pi r^2 h$
Volume of a cylinder = $\pi r^2 h$	Volume van 'n silinder = $\pi r^2 h$

	Solution/Oplissing	Marks Punte
11.2.1		(3)
11.2.2		(5)
		[14]

TOTAL/TOTAAL: 150



	Additional space/Bykomende ruimte	Marks Punte



	Additional space/Bykomende ruimte	Marks Punte

