

SA's Leading Past Year

Exam Paper Portal

STUDY

You have Downloaded, yet Another Great Resource to assist you with your Studies 😊

Thank You for Supporting SA Exam Papers

Your Leading Past Year Exam Paper Resource Portal

Visit us @ www.saexampapers.co.za



SA EXAM
PAPERS



**NATIONAL
SENIOR CERTIFICATE**

GRADE 12

JUNE 2023

LIFE SCIENCES

MARKS: 150

TIME: 2½ hours

This question paper consists of 18 pages.

INSTRUCTIONS AND INFORMATION

Read the following instructions carefully before answering the questions.

1. Answer ALL the questions.
2. Write ALL the answers in your ANSWER BOOK.
3. Start the answer to EACH question at the top of a NEW page.
4. Number the answers correctly according to the numbering system used in this question paper.
5. Present your answers according to the instructions of each question.
6. Do ALL drawings in pencil and label them in blue or black ink.
7. Draw diagrams, tables or flow charts only when asked to do so.
8. The diagrams in this question paper are NOT necessarily drawn to scale.
9. Do NOT use graph paper.
10. You may use a non-programmable calculator, protractor and a compass where necessary.
11. Write neatly and legibly.

SECTION A

QUESTION 1

1.1 Various options are given as possible answers to the following questions. Choose the answer and write only the letter (A–D) next to the question numbers (1.1.1 to 1.1.10) in the ANSWER BOOK, for example 1.1.11 D.

1.1.1 Which word/term describes the process shown in the diagram?

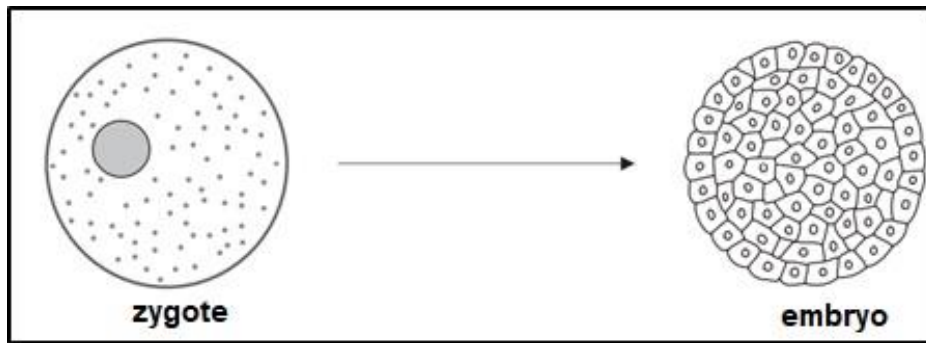

- A Fertilisation
- B Mitosis
- C Morula
- D Meiosis

1.1.2 The diagram shows a human 28-day menstrual cycle divided into four parts P, Q, R and S. The ovum is released on day 14.

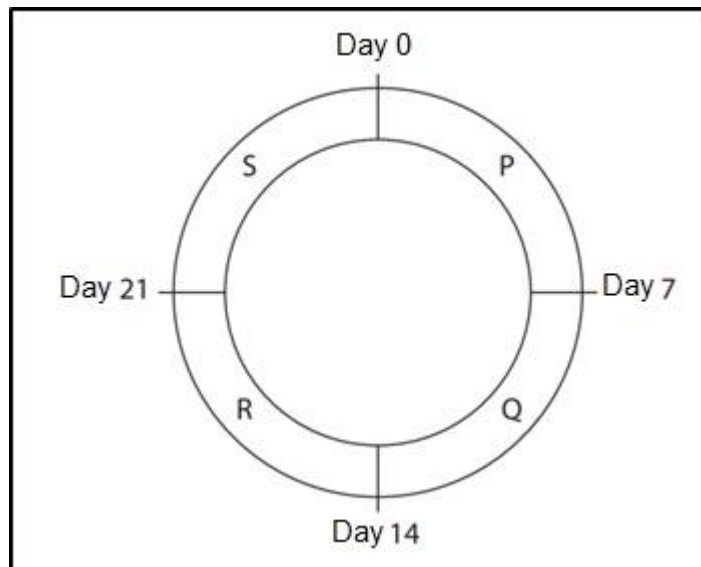

In which part of the cycle does menstruation occur?

- A P
- B Q
- C R
- D S

1.1.3 The diagram shows a section of the human brain.

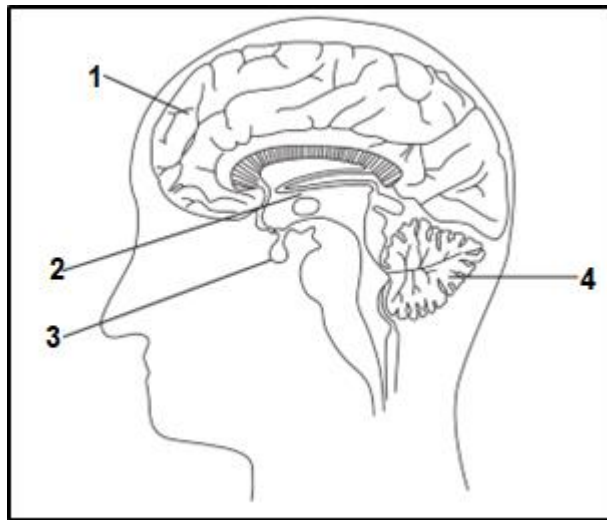

Which part is responsible for intelligence?

- A 1
- B 2
- C 3
- D 4

1.1.4 Which ONE of the following represents a single RNA nucleotide?

- A Deoxyribose-adenine-thymine
- B Adenine-ribose-phosphate
- C Deoxyribose-thymine-phosphate
- D Uracil-deoxyribose-phosphate

1.1.5 What percentage of thymine bases is present in a DNA molecule with 2 000 bases if 600 bases are guanine?

- A 20
- B 40
- C 30
- D 60

1.1.6 The central nervous system is made up of the ...

- A cranial and spinal nerves.
- B autonomic and peripheral nervous systems.
- C cranial nerves and the brain.
- D brain and the spinal cord.

1.1.7 The following table shows the events of mitosis and meiosis I.

MITOSIS		MEIOSIS I
(i)	The number of chromosomes remains the same	The number of chromosomes is halved
(ii)	Daughter cells formed are genetically different from each other	Daughter cells formed are genetically identical to each other
(iii)	Single chromosomes are arranged at the equator during metaphase	Homologous chromosomes pairs are arranged at the equator during metaphase
(iv)	Two daughter cells are formed	Four daughter cells are formed

Which ONE of the following is the correct difference between mitosis and meiosis I?

- A (ii), (iii) and (iv) only
- B (ii) and (iv) only
- C (i) and (iii) only
- D (i), (ii), (iii) and (iv)

QUESTIONS 1.1.8 AND 1.1.9 REFER TO THE DIAGRAMS SHOWING SOME PHASES OF MEIOSIS BELOW.

(The diagrams are not necessarily in the correct order.)

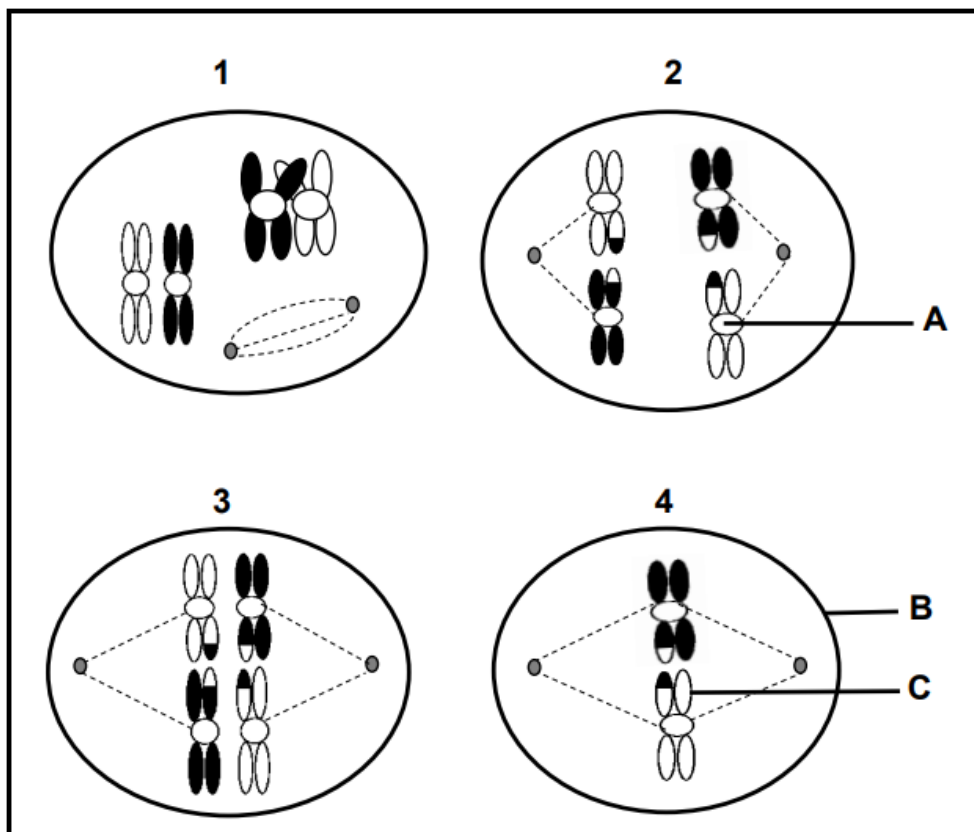

- 1.1.8 Which ONE of the following is CORRECT regarding labels **A**, **B** and **C** in the diagrams?

	A	B	C
A	Centrosome	Cell wall	Chromatid
B	Centromere	Cell membrane	Chromosome
C	Centromere	Cell membrane	Chromatid
D	Centrosome	Cell membrane	Chromatid

- 1.1.9 Which ONE of the following shows the correct sequence of the phases in meiosis?

- A 3, 1, 2, 4
 B 2, 1, 3, 4
 C 1, 3, 2, 4
 D 1, 2, 3, 4

- 1.1.10 A pair of homologous chromosomes involved in normal meiosis in an ovary carries the alleles shown below.

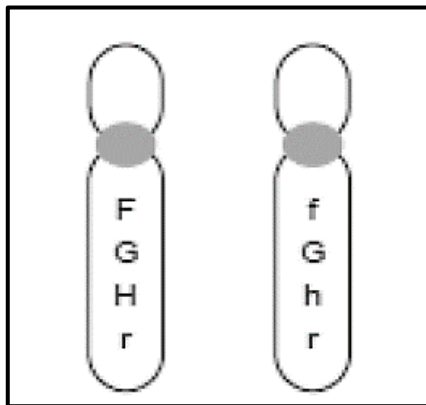

Possible chromosomes produced in the ova would include:

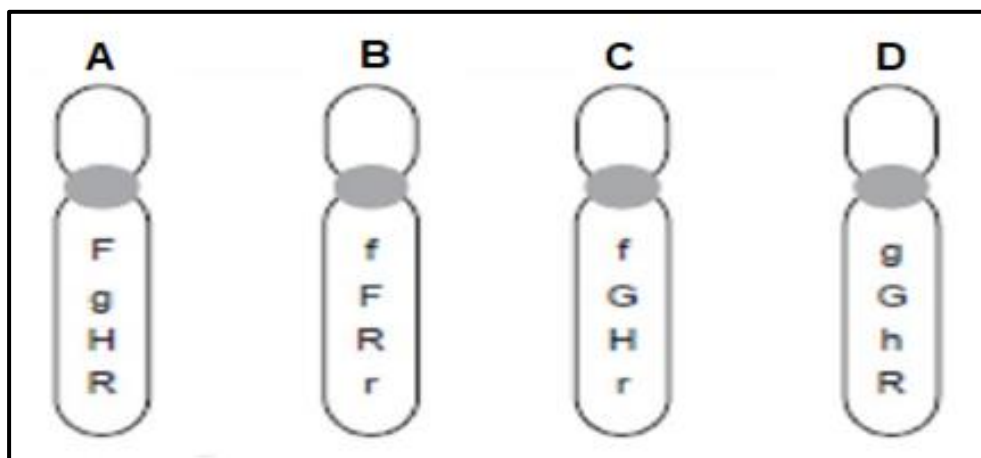

(10 x 2) (20)

1.2 Give the correct **biological term** for each of the following descriptions. Write only the term next to the question numbers (1.2.1 to 1.2.7) in the ANSWER BOOK.

1.2.1 The type of dominance resulting in an intermediate phenotype in the heterozygous condition

1.2.2 The name of the process when homologous chromosome pairs fail to separate during meiosis

1.2.3 The number, shape and arrangement of all the chromosomes in the nucleus of a somatic cell

1.2.4 A genetic disorder caused by the absence of a blood clotting agent

1.2.5 Protective membranes surrounding the brain and spinal cord

1.2.6 Eggs are retained/hatch in the female body and the young are born live

1.2.7 It includes the building of nests, protection, teaching of young and feeding – the care, or lack thereof, directly influences the survival of the young (7 x 1) (7)

1.3 Indicate whether each of the descriptions in COLUMN I applies to **A ONLY**, **B ONLY**, **BOTH A AND B** or **NONE** of the items in COLUMN II. Write **A only**, **B only**, **both A and B** or **none** next to the question numbers (1.3.1 to 1.3.3) in the ANSWER BOOK.

COLUMN I		COLUMN II	
1.3.1	Phase during which cytokinesis takes place	A:	Telophase I
		B:	Telophase II
1.3.2	Development in birds that is complete such that the young are born independent, with eyes open, with down feathers and able to move or feed independently	A:	Precocial development
		B:	Altricial development
1.3.3	Collects nitrogenous waste and assists in the exchange of gases	A:	Chorion
		B:	Allantois

(3 x 2) (6)

- 1.4 In watermelons, there are two alleles for taste, bitter fruit and sweet fruit. The allele for bitter fruit (**B**) is dominant over the allele for sweet fruit (**b**). There are two alleles for skin appearance, yellow spots and no spots. The allele for yellow spots (**N**) is dominant over the allele for no spots (**n**).

Plant **A**, which is heterozygous for bitter fruit and yellow spots, was crossed with plant **B**, which has sweet fruit and no spots.

- 1.4.1 Give the term that describes a genetic cross involving two characteristics. (1)
- 1.4.2 Give:
- (a) The genotype of plant **B** (2)
 - (b) The dominant phenotype for taste in watermelons (1)
 - (c) All possible genotypes of the gametes of plant **A** (2)
- 1.4.3 List TWO ways in which the phenotype of a watermelon with genotype $bbNn$ differs from the phenotype of a watermelon with genotype $Bbnn$. (2)
- 1.4.4 State Mendel's principle of independent assortment. (2)

1.5 The diagram below shows a genetic engineering process. A donor cell was taken from the skin cell of a male pig to create a new offspring.

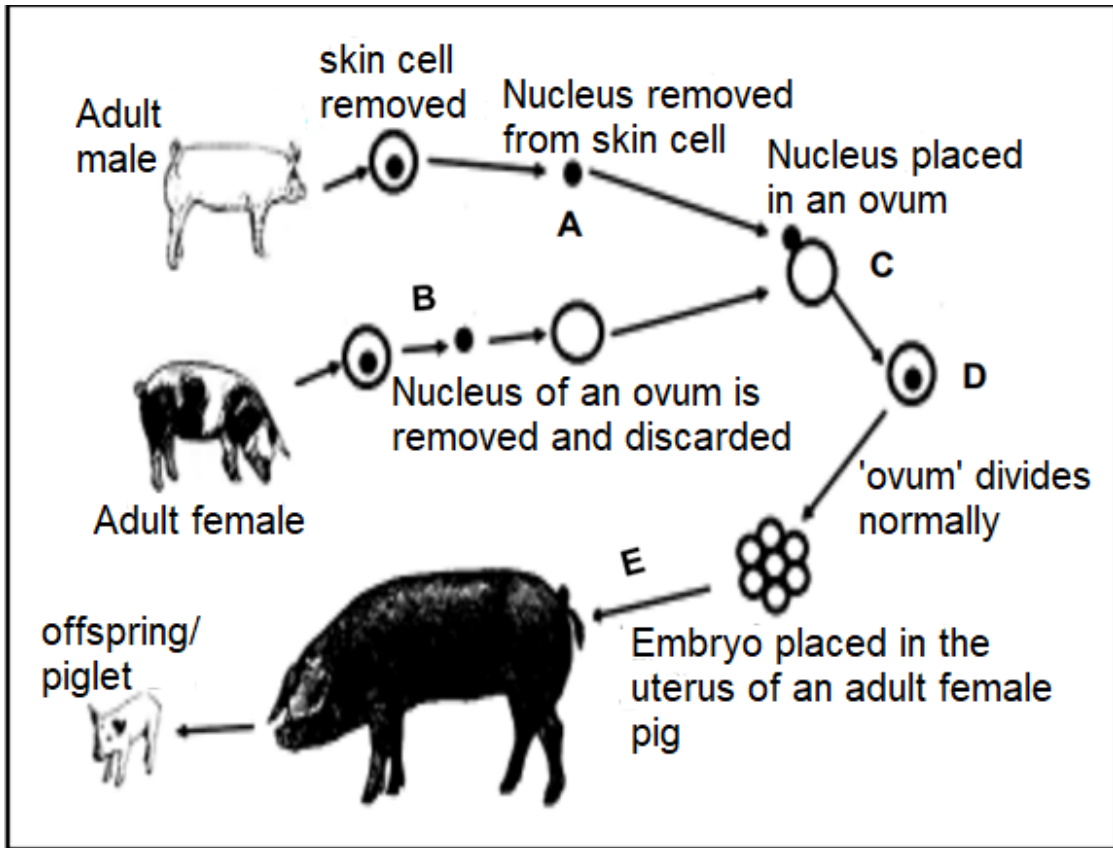

1.5.1 Name the genetic engineering process shown in the diagram above. (1)

1.5.2 State TWO advantages of the process mentioned in QUESTION 1.5.1 in agriculture. (2)

1.5.3 Name the type of cell division through which:

(a) Cell **D** divides (1)

(b) Ovum **B** is produced (1)

1.5.4 A somatic cell in a pig contains **38** chromosomes.

How many chromosomes would there be in:

(a) Structure **A** (1)

(b) A skin cell in organism **E** (1)

TOTAL SECTION A: 50

SECTION B

QUESTION 2

2.1 The diagram below represents part of a DNA molecule.

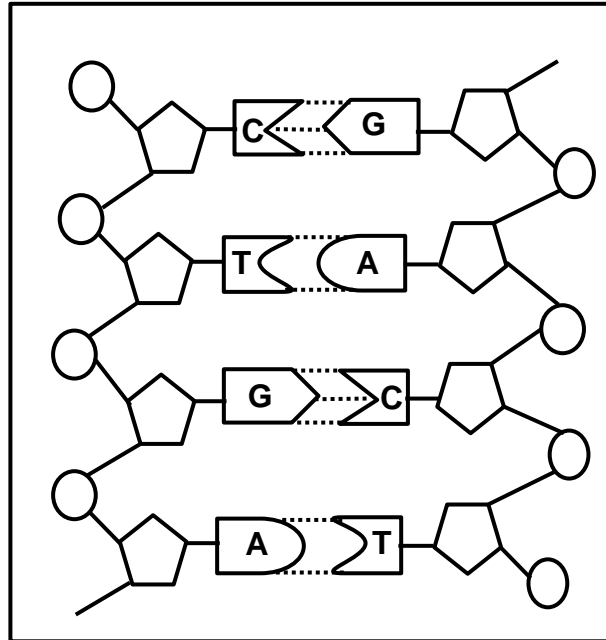

- 2.1.1 Name the structures inside the nucleus that contain DNA. (1)
- 2.1.2 Besides the nucleus, name ONE other place in a cell where DNA is found. (1)
- 2.1.3 What type of substances are labelled **A**, **G**, **C** and **T** in the DNA molecule shown above? (1)
- 2.1.4 The coded message in DNA is used in the process of protein synthesis.

Name and describe the stage during protein synthesis responsible for the copying of the coded message from DNA.

(*1 compulsory mark + Any 5) (6)

- 2.2 **Syndrome H** is an inherited condition. People with **syndrome H** do not produce the enzyme IDUA. All enzymes are proteins.

The diagram below shows part of a gene coding for the enzyme IDUA.

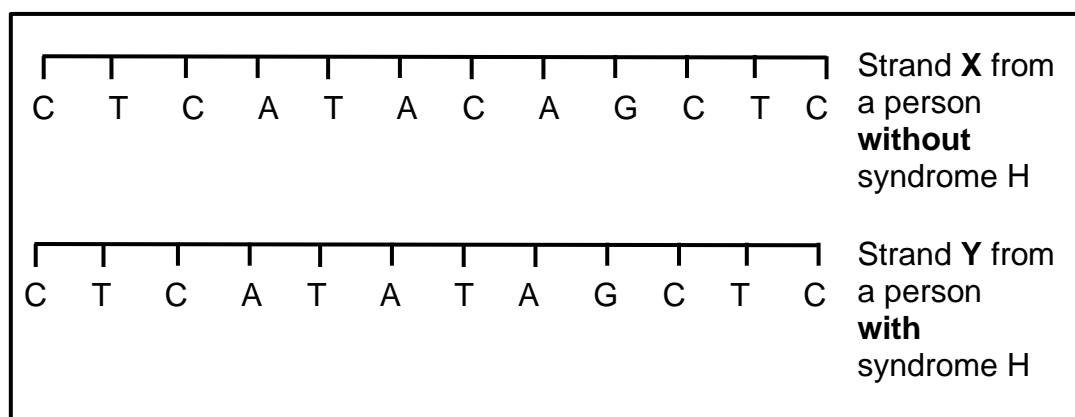

The table below shows mRNA anticodons and the amino acids they code for.

mRNA codons	Amino acid
AUA	Methionine
AUC	Isoleucine
CAG	Glutamine
CUC	Leucine
GAG	Glutamic acid
GUC	Valine
UAU	Tyrosine

- 2.2.1 For strand X, state the number of:
- Codons for the corresponding mRNA molecule (1)
 - Different amino acids coded for (1)
- 2.2.2 Give the DNA triplet on strand Y that codes for the amino acid glutamic acid. (1)
- 2.2.3 Strand Y shows a mutation in the DNA which has caused syndrome H.

The enzyme IDUA helps to break down a carbohydrate in the human body. The enzyme IDUA produced from Strand Y will not work.

- Explain how the mutation could cause the enzyme not to work. (5)

- 2.3 The diagram below is a representation of chromosomes during and after a certain process during meiosis.

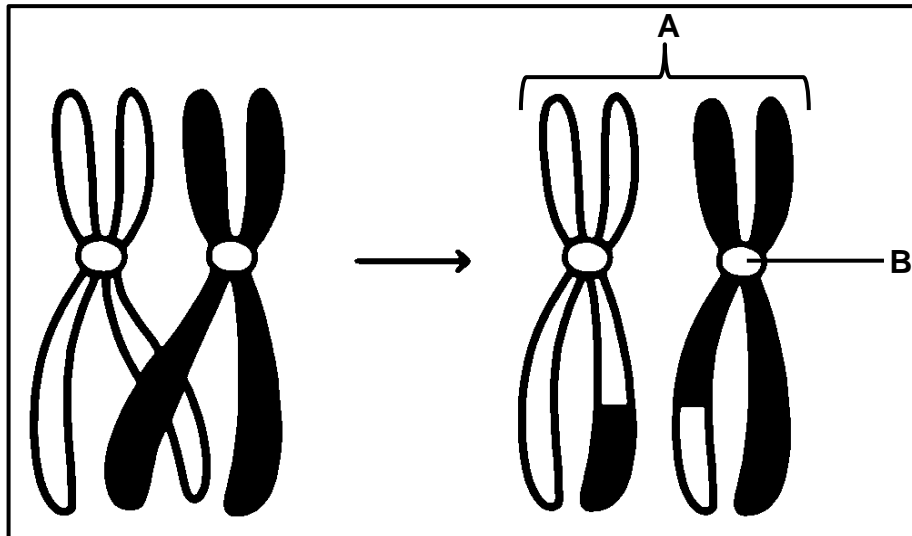

- 2.3.1 Name the process represented above. (1)
- 2.3.2 Identify part **A**. (1)
- 2.3.3 Give ONE function of part **B**. (1)
- 2.3.4 Describe the behaviour of chromosomes during the process mentioned in QUESTION 2.3.1. (3)
- 2.3.5 Explain ONE significance of the process shown. (2)

2.4 The graphs below show the blood hormone concentration of two ovarian hormones and changes that occur in the uterus lining during a 28-day cycle of a woman.

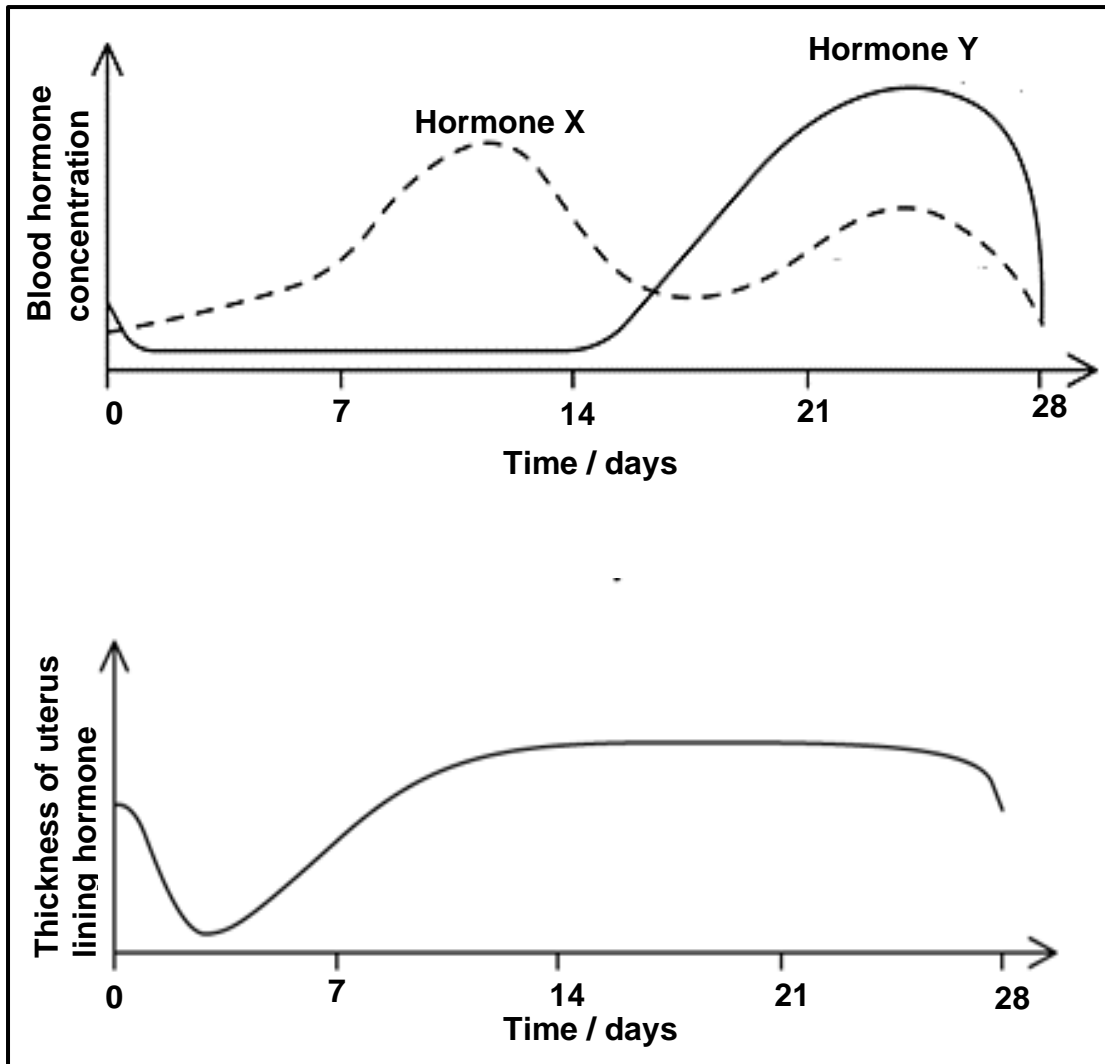

- 2.4.1 Identify hormone Y. (1)
- 2.4.2 Explain the reason for your answer to QUESTION 2.4.1 by referring to both graphs. (2)
- 2.4.3 State the biological term used for the uterus lining. (1)
- 2.4.4 Explain whether fertilisation occurred during the cycle of this woman. (3)
- 2.4.5 Name and describe how the two hormones secreted from the pituitary gland control the menstrual cycle. (4)

- 2.5 Cadasil is an inherited disorder which leads to the weakening of blood vessels in the brain. It is caused by a dominant allele (**D**).

The pedigree diagram shows the inheritance of Cadasil in a family.

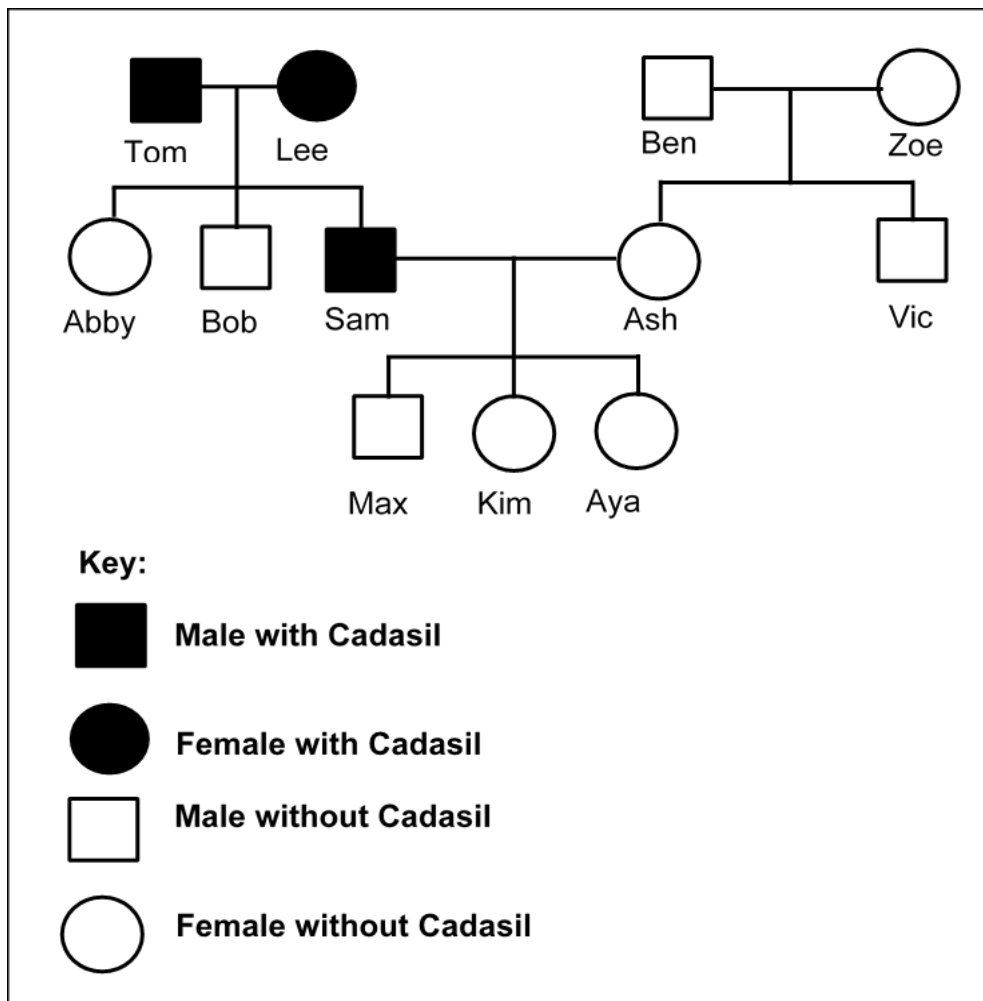

- 2.5.1 (a) State what a dominant allele is. (1)
- (b) Give evidence from the pedigree diagram that Cadasil is caused by a dominant allele. (1)
- 2.5.2 (a) Is Sam homozygous or heterozygous for the Cadasil allele? (1)
- (b) Give evidence from the diagram for your answer to QUESTION 2.5.2 (a). (1)
- 2.5.3 Sam and Ash are planning to have another baby.
- Use a genetic cross to find the percentage chance that the new baby will develop into a person with Cadasil. (6)

2.6 Read the passage below and answer the questions that follow.

Scientists are trying to develop treatment for Cadasil by using stem cells.

Specially treated stem cells would be injected into the damaged part of the brain. Embryonic stem cells can be obtained by removing a few cells from a human embryo. Scientists have discovered how to change adult skin cells into stem cells.

2.6.1 Why would scientists use stem cells in the treatment of Cadasil? (3)

2.6.2 Suggest ONE advantage of using stem cells from adult skin cells than from embryos. (1)

[50]

QUESTION 3

3.1 The diagram shows sperm cells, viewed using a microscope, from two different men.

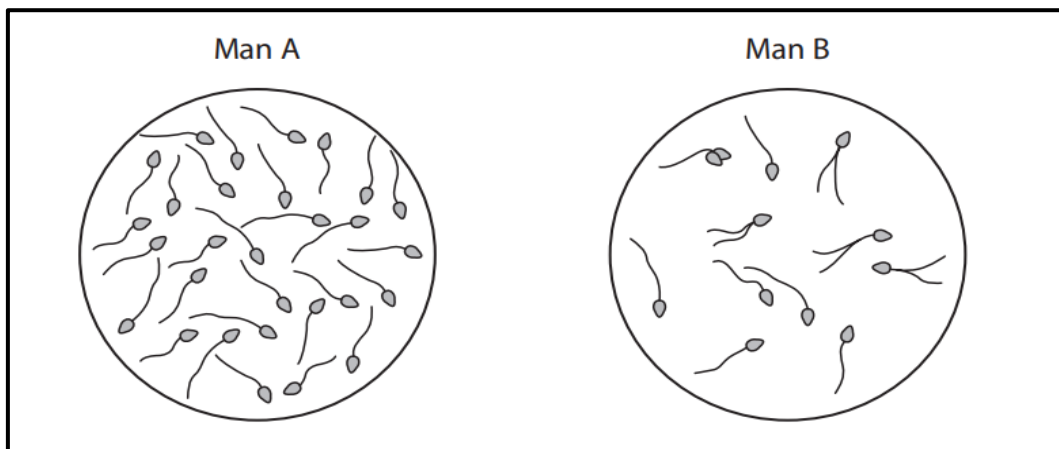

- 3.1.1 Use the information in the diagram to give TWO reasons why man **A** is more fertile than man **B**. (2)
- 3.1.2 Discuss TWO structural adaptations of the sperm cells to reach the ovum in the Fallopian tube of the female. (4)
- 3.1.3 “The father determines the gender of a baby.” Explain why this statement can be regarded as true. (3)
- 3.1.4 Tabulate TWO differences between spermatogenesis and oogenesis. (5)

3.2 The diagram shows part of the human ear.

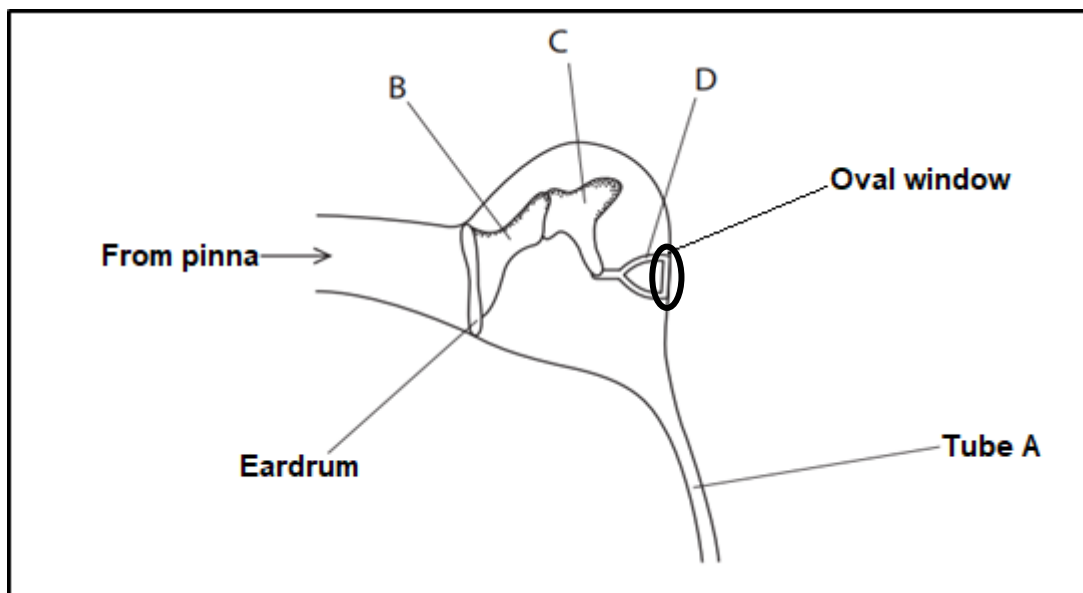

- 3.2.1 Name the part of the ear that contains structures **B**, **C** and **D**. (1)
- 3.2.2 Give the collective name for structures **B**, **C** and **D**. (1)
- 3.2.3 Explain the consequence if part **B** and **C** are fused. (2)

3.2.4 Tube **A** may be blocked when a person has a throat infection. Name tube **A** and explain why it would be dangerous for such a person to go skydiving. (4)

3.2.5 Explain how the eardrum and the oval window contribute to the amplification of sound. (2)

3.3 The diagram below shows a bee flying towards a man's eye.

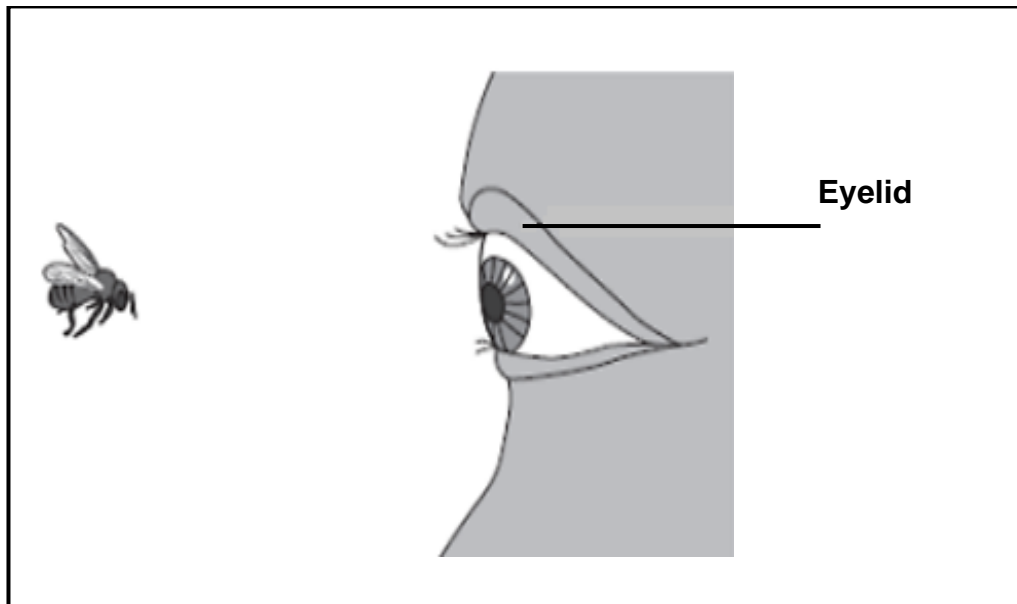

As the bee approaches the man's eye, light from the bee reaches the light sensitive cells in the eye. The muscles in the eyelid shut the man's eye before the bee hits his eye.

3.3.1 Name the type of response that results in the shutting of the man's eye before the bee hits his eye. (1)

3.3.2 Describe the pathway taken by the nerve impulse to cause the response mentioned in QUESTION 3.3.1. (5)

3.3.3 The population of the USA is 322 million, of which 151,34 million are over 40 years of age. 17,2% of the people over the age of 40 develop a cataract.

(a) Explain how a cataract would affect the ability to see. (2)

(b) Calculate the number of people in the USA over the age of 40 who develop a cataract. (3)

3.4 Scientists conducted an investigation to determine the effect of caffeine on an individual's reaction time.

The procedure was as follows:

- (i) Individual **A** held a 30 cm ruler just above the hand of individual **B**.
- (ii) Individual **A** let go of the ruler.
- (iii) Individual **B** caught the ruler as soon as possible.
- (iv) The experiment was repeated seven more times
- (v) Individual **B** (catcher) drank a cup of strong coffee.
- (vi) Coffee contains caffeine
- (vii) Fifteen (15) minutes after individual **B** drank the coffee, steps (i)–(iv) were repeated.

The results of the experiment are presented in the table below:

Experiment	Distance the ruler fell before it was caught (cm)	
	Before drinking coffee	After drinking coffee
1	18	8
2	21	13
3	25	11
4	15	17
5	19	10
6	16	14
7	12	13
8	21	13
Average	18,4	X

3.4.1 Identify the:

- (a) Independent variable (1)
- (b) Dependent variable (1)

3.4.2 Calculate the average distance indicated as **X** in the table above. (2)

3.4.3 State ONE way in which the reliability of the investigation was ensured. (1)

3.4.4 Suggest TWO ways in which the reliability of this investigation can be improved. (2)

3.4.5 Plot a bar graph showing the average distance the ruler fell before it was caught before and after drinking coffee. (6)

3.4.6 The scientists used the reading on the ruler as a measure of the reaction time.

By looking at the results what can you conclude about the effect of caffeine on reaction time. (2)

[50]

TOTAL SECTION B: 100
GRAND TOTAL: 150